

AcerPower SC User's guide

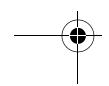

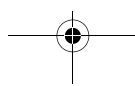
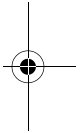
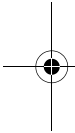

Copyright © 2001 Acer Incorporated
All Rights Reserved.

AcerPower SC
User's guide

Changes may be made periodically to the information in this publication without obligation to notify any person of such revision or changes. Such changes will be incorporated in new editions of this manual or supplementary documents and publications. This company makes no representations or warranties, either expressed or implied, with respect to the contents hereof and specifically disclaims the implied warranties of merchantability or fitness for a particular purpose.

Record the model number, serial number, purchase date, and place of purchase information in the space provided below. The serial number and model number are recorded on the label affixed to your computer. All correspondence concerning your unit should include the serial number, model number, and purchase information.

No part of this publication may be reproduced, stored in a retrieval system, or transmitted, in any form or by any means, electronic, mechanical, photocopy, recording, or otherwise, without the prior written permission of Acer Incorporated.

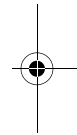
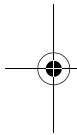

Model Number : _____

Serial Number: _____

Purchase Date: _____

Place of Purchase: _____

Acer and the Acer Logo are registered trademarks of Acer Inc. Other company's product names or trademarks are used herein for identification purposes only and belong to their respective companies.

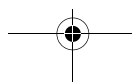



Notices

FCC notice

This device has been tested and found to comply with the limits for a Class B digital device pursuant to Part 15 of the FCC Rules. These limits are designed to provide reasonable protection against harmful interference in a residential installation. This device generates, uses, and can radiate radio frequency energy and, if not installed and used in accordance with the instructions, may cause harmful interference to radio communications.

However, there is no guarantee that interference will not occur in a particular installation. If this device does cause harmful interference to radio or television reception, which can be determined by turning the device off and on, the user is encouraged to try to correct the interference by one or more of the following measures:

- Reorient or relocate the receiving antenna
- Increase the separation between the device and receiver
- Connect the device into an outlet on a circuit different from that to which the receiver is connected
- Consult the dealer or an experienced radio/television technician for help

Notice: Shield cables

All connections to other computing devices must be made using shielded cables to maintain compliance with FCC regulations.

Notice: Peripheral devices

Only peripherals (input/output devices, terminals, printers, etc.) certified to comply with the Class B limits may be attached to this equipment. Operation with noncertified peripherals is likely to result in interference to radio and TV reception.



Caution: Changes or modifications not expressly approved by the manufacturer could void the user's authority, which is granted by the Federal Communications Commission, to operate this computer.



Use conditions

This part complies with Part 15 of the FCC Rules. Operation is subject to the following two conditions: (1) this device may not cause harmful interference, and (2) this device must accept any interference received, including interference that may cause undesired operation.

Notice: Canadian users

This Class B digital apparatus meets all requirements of the Canadian Interference-Causing Equipment Regulations.

Remarque à l'intention des utilisateurs canadiens

Cet appareil numérique de la classe B respecte toutes les exigences du Règlement sur le matériel brouilleur du Canada.

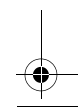
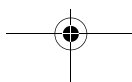
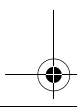
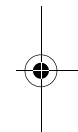
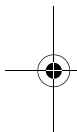



Important safety instructions

Read these instructions carefully. Save these instructions for future reference.

- 1** Follow all warnings and instructions marked on the product.
- 2** Unplug this product from the wall outlet before cleaning. Do not use liquid cleaners or aerosol cleaners. Use a damp cloth for cleaning.
- 3** Do not use this product near water.
- 4** Do not place this product on an unstable cart, stand, or table. The product may fall, causing serious damage to the product.
- 5** Slots and openings in the cabinet and the back or bottom are provided for ventilation; to ensure reliable operation of the product and to protect it from overheating, these openings must not be blocked or covered. The openings should never be blocked by placing the product on a bed, sofa, rug, or other similar surface. This product should never be placed near or over a radiator or heat register, or in a built-in installation unless proper ventilation is provided.
- 6** This product should be operated from the type of power indicated on the marking label. If you are not sure of the type of power available, consult your dealer or local power company.
- 7** Do not allow anything to rest on the power cord. Do not locate this product where persons will walk on the cord.
- 8** If an extension cord is used with this product, make sure that the total ampere rating of the equipment plugged into the extension cord does not exceed the extension cord ampere rating. Also, make sure that the total rating of all products plugged into the wall outlet does not exceed the fuse rating.
- 9** Never push objects of any kind into this product through cabinet slots as they may touch dangerous voltage points or short out parts that could result in a fire or electric shock. Never spill liquid of any kind on the product.
- 10** Do not attempt to service this product yourself, as opening or removing covers may expose you to dangerous voltage points or other risks. Refer all servicing to qualified service personnel.
- 11** Unplug this product from the wall outlet and refer servicing to qualified service personnel under the following conditions:

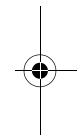
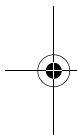

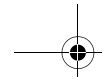

12 When the power cord or plug is damaged or frayed

- a** If liquid has been spilled into the product
- b** If the product has been exposed to rain or water
- c** If the product does not operate normally when the operating instructions are followed. Adjust only those controls that are covered by the operating instructions since improper adjustment of other controls may result in damage and will often require extensive work by a qualified technician to restore the product to normal condition.
- d** If the product has been dropped or the cabinet has been damaged
- e** If the product exhibits a distinct change in performance, indicating a need for service.
- f** Replace the battery with the same type as the product's battery we recommend. Use of another battery may present a risk of fire or explosion. Refer battery replacement to a qualified serviceman.

13 Warning! Batteries may explode if not handled properly. Do not disassemble or dispose of them in fire. Keep them away from children and dispose of used batteries promptly.

14 Use only the proper type of power supply cord set (provided in your accessories box) for this unit. It should be a detachable type: UL listed/CSA certified, type SPT-2, rated 7A 125V minimum, VDE approved or its equivalent. Maximum length is 15 feet (4.6 meters).

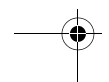
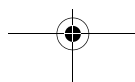
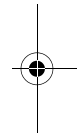
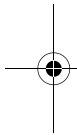

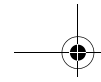

Laser compliance statement

The CD-ROM drive in this computer is a laser product. The CD-ROM drive's classification label (shown below) is located on the drive.

CLASS 1 LASER PRODUCT

CAUTION: INVISIBLE LASER RADIATION WHEN OPEN. AVOID EXPOSURE TO BEAM.

Lithium battery statement

CAUTION

Danger of explosion if battery is incorrectly replaced. Replace only with the same or equivalent type recommended by the manufacturer. Discard used batteries according to the manufacturer's instructions.

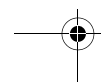
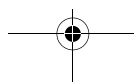
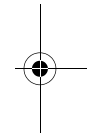
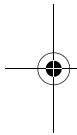

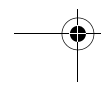
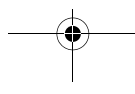
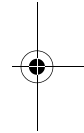
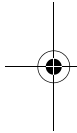
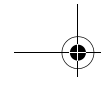



Contents

1 Overview	1
Package contents	3
Taking care of your computer	4
Important tips	4
Cleaning and servicing	4
2 System tour	7
Features	9
Front panel	10
Rear panel	11
USB Keyboard	12
Programmable keys	13
Internet/Suspend keys	13
Multimedia keys	13
Volume control/Mute	14
Cursor keys	14
Lock keys	14
Windows keys	15
Mouse	16
Disk drives	17
3.5-inch floppy disk drive	17
CD-ROM drive	17
Hard disk drive	19
3 Setting up your computer	21
Arranging a comfortable work area	23
Adjusting your chair	23
Positioning your PC	23
Positioning your monitor	23
Positioning your keyboard	24
Positioning your mouse	24
Connecting peripherals	25
Mouse	25
USB Keyboard	26
Monitor	27
Power cable	28
Connecting options	29
Printer	29
Network	30
Modem	31
Multimedia devices	32
USB devices	33

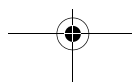
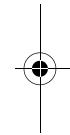
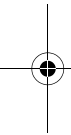



x

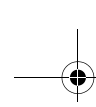

Turning on your computer	34
Turning off your computer	36
4 Upgrading your computer	37
Installation precautions	39
ESD precautions	39
Preinstallation instructions	39
Post-installation instructions	40
Opening your computer	41
Removing the cover	41
Replacing the cover	43
Mainboard	45
CPU frequency table	47
Installing additional memory	48
Installing a DIMM	48
Removing a DIMM	49
Reconfiguring your computer	49
Upgrading the CPU	50
Replacing the hard disk	52
Installing an expansion card	57

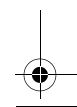
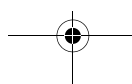
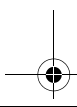
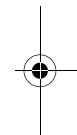
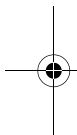

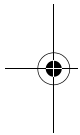
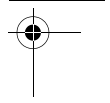
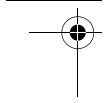
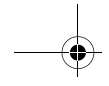

1 Overview

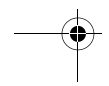
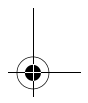
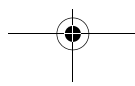
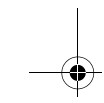
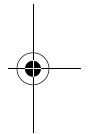

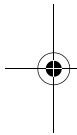

This chapter gives an overview of the product and the peripherals that come with it. It also contains tips on how to take care of your computer.

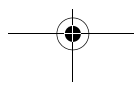
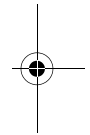

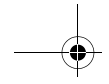

Package contents

Before you unpack your computer, make sure that you have enough space to set up your computer.

Carefully unpack the carton and remove the contents. If any of the following items are missing or damaged, contact your dealer immediately:

- AcerPower SC
- USB keyboard
- Mouse
- Power cable
- User's guide
- Other user documentation and third-party software

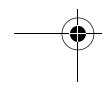
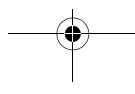
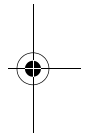
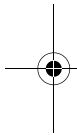



Taking care of your computer

Please read the important instructions listed in this section. Following these instructions will help you maximize the durability of your computer.

Important tips

- Do not expose the computer to direct sunlight. Do not place it near sources of heat, such as a radiator.
- Do not subject the computer to magnetic fields.
- Do not expose the computer to rain or moisture.
- Do not spill water on the computer.
- Do not subject the computer to heavy shock or vibration.
- Do not expose the computer to dust and dirt.
- Never place the system on uneven surfaces.
- Do not step on the power cord or place heavy objects on top of it. Carefully route the power cord and any cables away from personal traffic.
- When unplugging the power cord, do not pull on the cord itself but pull on the plug.
- The total ampere rating of the equipment plugged in should not exceed the ampere rating of the cord if you are using an extension cord. Also, the total current rating of all equipment plugged into a single wall outlet should not exceed the fuse rating.
- Check the documentation that came with your software programs to see if you can select other combinations of resolution and color. These adjustments could make viewing the screen more comfortable.

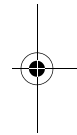
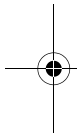

Cleaning and servicing

To clean your computer and keyboard

- 1** Turn off the computer and unplug the power cord.
- 2** Use a soft cloth moistened with water and gently wipe the exterior of the computer and the keyboard. Do not use liquid or aerosol cleaners.



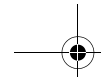

To clean your mouse

- 1** Open the circular cover underneath the mouse.
- 2** Take out the rubber ball and wipe it with a soft, damp cloth.
- 3** Put the ball back and close the cover.

To clean your monitor

Make sure that you keep your screen clean. For cleaning instructions, refer to the documentation that came with your monitor.

When to contact a service technician

- If you dropped and damaged the computer.
- If liquid has been spilled into the computer.
- If the computer is not operating normally.

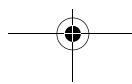
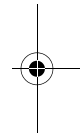
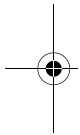

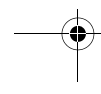
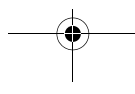
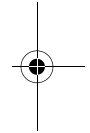
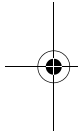
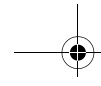

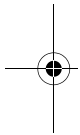
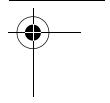
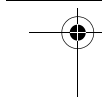
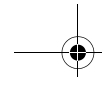

2 System tour

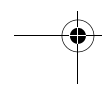
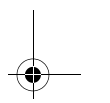
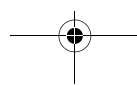
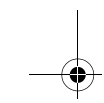
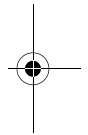

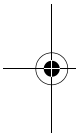
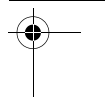
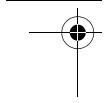
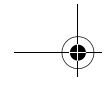

This chapter discusses the features and components of your computer.

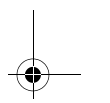
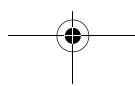
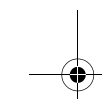
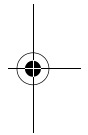

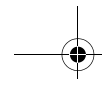

Features

Here are just a few of your computer's many features:

Performance

- Socket 370 processor
 - Intel® Celeron™ processor with built-in L2 cache
 - Intel® Pentium® III processor with 256K of Advanced Transfer Cache (front side bus of 100 and 133 MHz supported)
- Expandable system memory to a maximum of 1-GB
- Power management function
- 3.5-inch floppy disk drive and CD-ROM drive
- High-capacity, Enhanced-IDE hard disk

Multimedia

- Integrated 128-bit 2D/3D graphics accelerator (embedded in SiS630ET chipset)
- Integrated 3D positional audio controller (embedded in SiS630ET chipset)
- Audio-in/Line-in, Audio-out/Line-out, Mic-in, and Game/MIDI interfaces

Connectivity

- PS/2 mouse and USB keyboard interface
- One serial port, one parallel port, and one VGA port
- Universal Serial Bus (USB) ports
- Integrated 10Base-T/100Base-TX network support with remote wake-up function (embedded in SiS630ET chipset)
- High-speed fax/data PCI modem (optional)

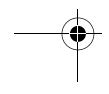
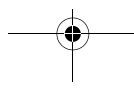
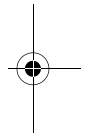
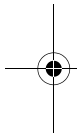



Front panel

Your computer's front panel consists of the following:

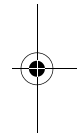
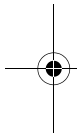
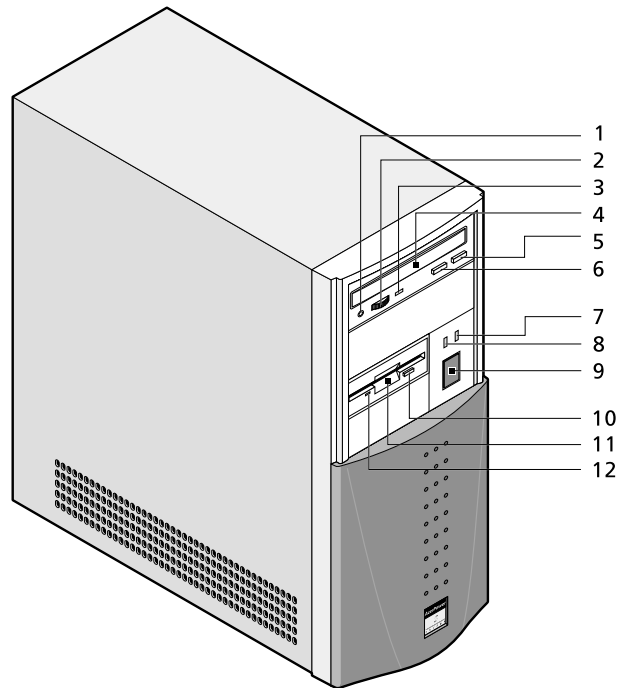

No.	Component	No.	Component
1	Headphone/Earphone port	7	Power LED
2	Increase/decrease volume	8	LAN LED
3	CD-ROM LED	9	Power button
4	CD-ROM tray	10	3.5-inch floppy disk drive eject button
5	Stop/Eject button	11	3.5-inch floppy disk drive
6	Skip/Forward button	12	3.5-inch floppy disk drive LED

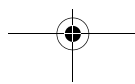

Rear panel

Your computer's rear panel consists of the following:

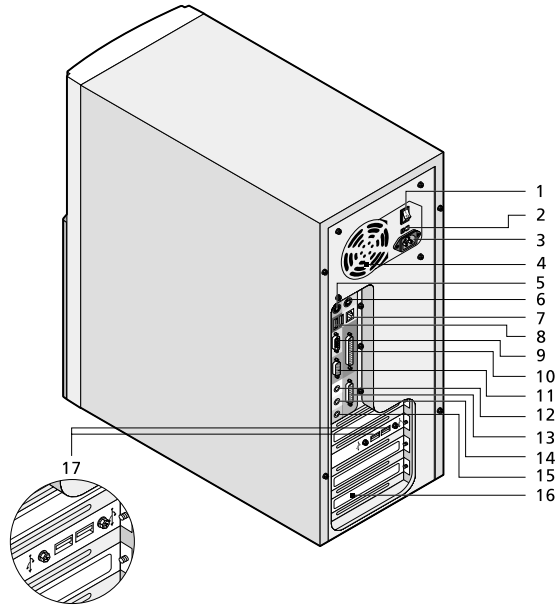

No.	Component	No.	Component
1	System main power switch	10	Parallel port
2	Voltage selector	11	VGA/Monitor port
3	System power socket	12	Speaker-out/Line-out port
4	Fan	13	Game/MIDI port
5	PS/2 keyboard port	14	Line-in port
6	PS/2 mouse port	15	Microphone-in port
7	LAN port	16	Add-on brackets
8	USB ports	17	Optional USB ports*
9	Serial 2 port		

*These two optional USB ports are only available in some regions.

For information on how to connect the peripherals, see "Connecting peripherals" on page 25 and "Connecting options" on page 29.

USB Keyboard

The USB keyboard that came with your computer has full-sized keys that include separate cursor keys, two Windows keys, and twelve function keys.

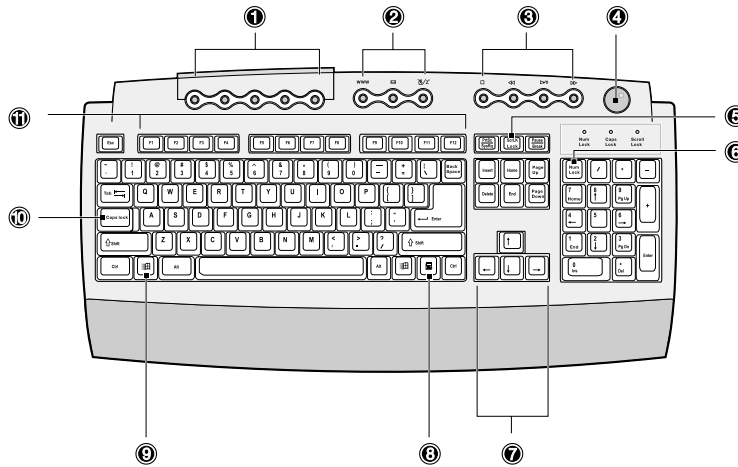



No.	Description
1	Programmable keys
2	Internet/Suspend keys
3	Multimedia keys
4	Volume/Mute nob
5	Scroll lock key
6	Num lock key
7	Cursor keys
8	Application key
9	Windows keys
10	Caps lock key
11	Function keys

Programmable keys

The programmable keys help you directly access a URL (Web site) or launch any program, file, or application in your system. The fifth key is set to launch the media player. If you want to configure the settings of each key, right click on the Magic Keyboard icon located in your Windows desktop.



Internet/Suspend keys

The Internet/Suspend keys consist of three buttons:

Icon	Key	Description
	Email	Launches your email application.
WWW	Web browser	Launches your current default browser.
	Suspend/Resume	Press this button to put the system to sleep. Press again to wake the system up.

Multimedia keys

The multimedia keys Allow you to play, pause, stop, step forward, or step back a song or movie conveniently using your keyboard.

Icon	Key	Description
	Play/Pause	Press to start playing an audio or video file. Press again to pause.
	Stop	Press to stop playing the audio or video file.
	Forward	Press to skip forward to the next file and start playing.

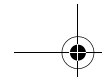

Icon	Key	Description
	Backward	Press to skip backward to the previous file and start playing.

Volume control/Mute



The volume control/mute knob controls the speaker volume. Turn it clockwise or counterclockwise to adjust the volume. Press it to toggle between mute and sound.

Cursor keys

The cursor keys, also called the arrow keys, let you move the cursor around the screen. They serve the same function as the arrow keys on the numeric keypad when the Num Lock is toggled off.

Lock keys

The keyboard has three lock keys which you can toggle on and off to switch between two functions.

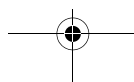
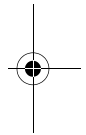
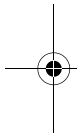

Lock Key	Description
Caps Lock	When activated, all alphabetic characters typed appear in uppercase (same function as pressing Shift + <letter>).
Num Lock	When activated, the keypad is set to numeric mode; i.e., the keys function as a calculator (complete with arithmetic operators such as +, -, *, and /).
Scroll Lock	When activated, the screen moves one line up or down when you press the up arrow or down arrow respectively. Take note that Scroll Lock may not work with some applications.

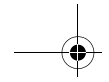



Windows keys

The keyboard has two keys that perform Windows-specific functions.

Key	Description
Windows logo key 	Start button. Combinations with this key perform special functions, such as: <ul style="list-style-type: none">• Windows + Tab: Activate the next Taskbar button• Windows + E: Explore My Computer• Windows + F: Find Document• Windows + M: Minimize All• Shift + Windows + M: Undo Minimize All• Windows + R: Display Run dialog box
Application key 	Opens the applications context menu (same function as clicking the right button of the mouse).

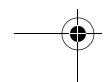
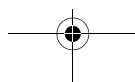
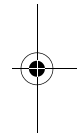
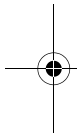



Mouse

Your mouse has one ratchet wheel and two buttons: a left button and a right button. Quickly pressing and releasing the buttons is called clicking. Sometimes, you will need to do a double-click (clicking the same button twice quickly) or a right-click (clicking the right button quickly).

The ratchet wheel in between the two buttons is added to provide easier scrolling capability. By simply moving the wheel with your index finger, you can quickly move through multiple pages, lines, or windows. The wheel may also function as a third button allowing you to quickly click or double-click an icon or a selected item.

For information on how to clean your mouse, see "To clean your mouse" on page 5

PS/2 Mouse

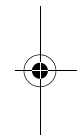
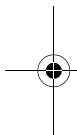
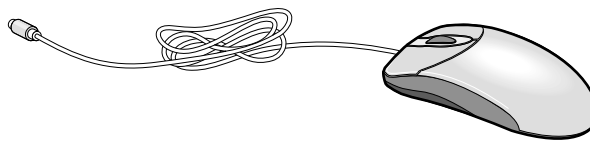

USB Mouse

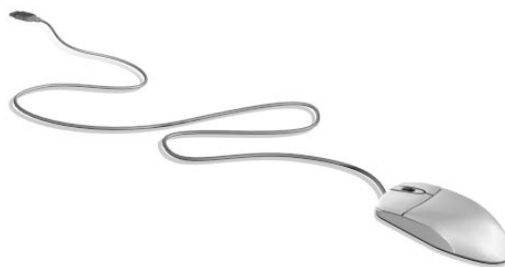

Note: If you are left-handed, refer to your Windows manual for instructions on how to set up your mouse for left-handed use.



Disk drives

Your computer comes with the following disk drives.

3.5-inch floppy disk drive

Your computer's 3.5-inch floppy disk drive can handle 720-KB and 1.44-MB capacity diskettes.

The floppy diskettes are compact, lightweight, and easy to carry around. Here are some tips on how to take care of your diskettes:

- Always make backup copies of the diskettes that contain important data or program files.
- Keep diskettes away from magnetic fields and sources of heat.
- Avoid removing a diskette from a drive when the floppy drive activity light is on.
- Write-protect your diskettes to prevent accidental erasure. To do this, slide the write-protect tab to the write-protect position.

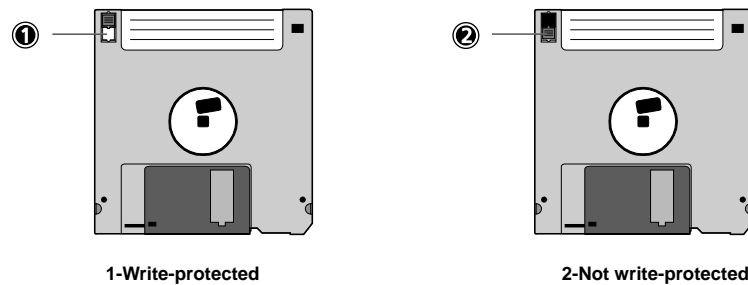

- When you put a label on a 3.5-inch diskette, make sure that the label is properly attached (flat on the surface) and within the labeling area (area with a slight surface depression) on the diskette. An improperly attached label may cause a diskette to get stuck in a drive when you are inserting or removing it.

CD-ROM drive

Your CD-ROM drive, located on the front panel of your computer, allows you to play different types of Compact Discs (CDs). CDs, like diskettes, are also compact, lightweight, and easy to carry around.



However, they are more delicate than diskettes and must be handled with extra care.

To insert a CD into your computer's CD-ROM drive:

- 1 Gently push the eject button located on the front panel.
- 2 Insert the CD. Make sure that the label or title side of the CD is facing upward.



.....
Caution: Hold the CD by the edges to avoid leaving smudges or fingerprints.

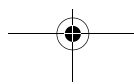
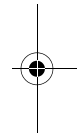
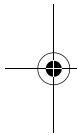
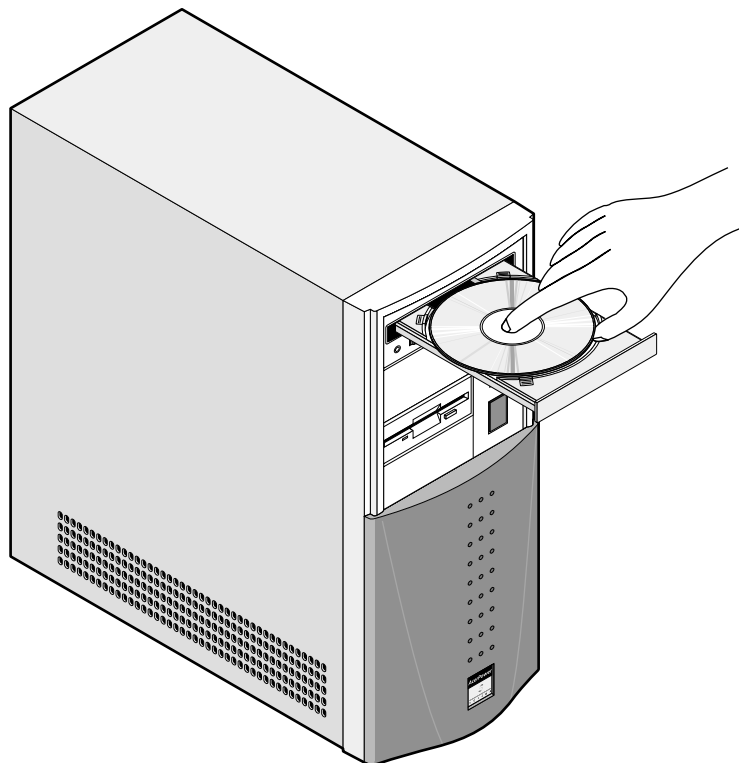

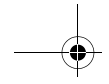

Caution: Make sure that the CD is properly inserted before closing the CD tray. Improper insertion may damage both the CD and the CD-ROM drive.

3 Gently close the tray.

To take care of your CDs:

- Keep your CDs in a disk case when not in use to avoid scratches or other damage. Any kind of dirt or damage can affect the data on the disc, impair the disc lens reader on the CD-ROM drive, or stop the computer from successfully reading the disc.
- When handling CDs, always hold them by the edges to avoid smudges or fingerprints.
- When cleaning CDs, use a clean, dust-free cloth and wipe in a straight line from the center to the edge. Do not wipe in a circular motion.
- Clean your CD-ROM drive periodically. You may refer to the Cleaning Kit for instructions. Cleaning Kits can be purchased in any computer or electronics shop.

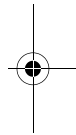
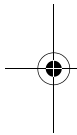

Hard disk drive

Your computer is preinstalled with a high-capacity Enhanced-IDE (E-IDE) hard disk drive. If you want to replace your hard disk or upgrade it, contact your dealer or a qualified service technician for support.

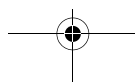

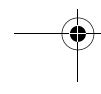
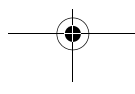
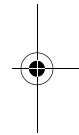
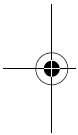
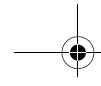

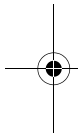
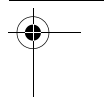
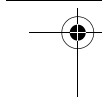
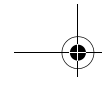

3 Setting up your computer

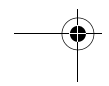
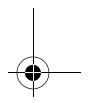
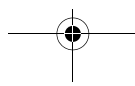
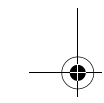
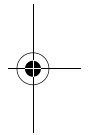

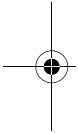
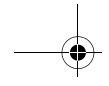

This chapter contains step-by-step instructions on how to set up your computer and connect additional peripherals.

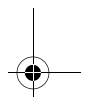
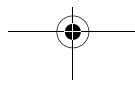
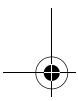
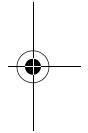

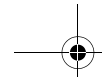

Arranging a comfortable work area

Working safely begins with the arrangement of your work space and the proper use of equipment. For this reason, it is very important to take time and think about how you are going to arrange your work area.

Here are some points to consider:

Adjusting your chair

Having the right kind of chair does not necessarily mean that you'll be properly supported. It is necessary to adjust your chair to fit your body. Proper body posture will make you more comfortable and productive.

- Avoid tilting your chair. If you have a chair that tilts, lock those tilt knobs so that your chair will not tilt forward or backward while you are using your computer.
- Adjust your chair height in such a way that you can sit on it with your thighs parallel to the floor and your feet resting flat on the floor.
- Rest your body on the chair back. Your torso works harder to maintain balance if you do not rest your body on the chair back.

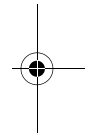
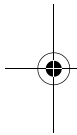

Positioning your PC

- Do not put your computer near any equipment that might cause electromagnetic or radio frequency interference such as radio transmitters, televisions, copy machines, or heating and air-conditioning equipment.
- Avoid dusty areas and extremes of temperature and humidity.
- You may place your computer beside your desk or under your table, as long as it does not block the space that you need for working and moving.

Positioning your monitor

Place your monitor at a comfortable viewing distance, usually 50 to 60 centimeters away. Adjust the display in such a way that the top of the screen is at or slightly below eye level.

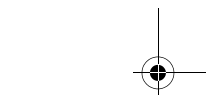
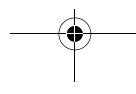

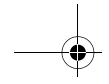

Positioning your keyboard

The location of the keyboard is a very important factor to your posture. Placing it too far will make your body lean forward forcing you to sit in an unnatural position. Placing it too high will add tension to your shoulder muscles.

- The keyboard should be placed just above your lap. Adjust the keyboard height by flipping the folding stands located under the keyboard.
- Keep your lower arms parallel to the floor as you type. Your upper arms and shoulders should be relaxed. Then try typing with a light touch. If you feel any shoulder or neck strain, stop for a while and check your posture.
- Position your keyboard in front of your monitor. Putting your keyboard beside your monitor will make you turn your head while you type which could add tension to your neck muscles that may later result in neck strain.

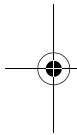

Positioning your mouse

- The mouse should be placed on the same surface as your keyboard so that you can reach it with ease.
- Adjust its position to allow enough space for movement without making you stretch or lean over.
- Use your arm to move the mouse. Do not rest your wrist on the table when moving the mouse.

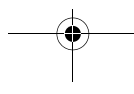
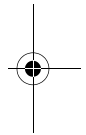

Connecting peripherals

Setting up your computer is easy. For the most part, you only have four things to connect: the mouse, the USB keyboard, the monitor and the power cable.

Mouse

Plug the mouse cable into the PS/2 mouse port or USB port located on the rear panel of your computer.

Connecting the PS/2 mouse

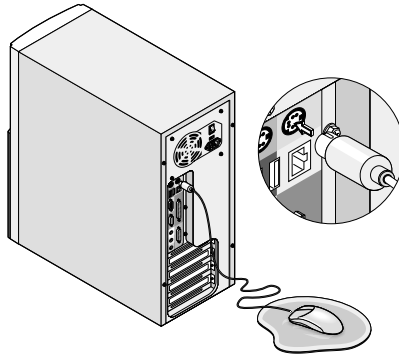

Connecting the USB mouse

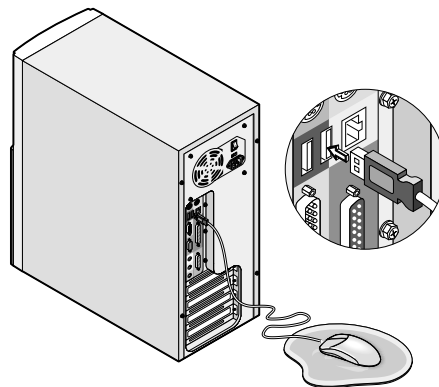

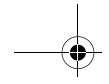

USB Keyboard

Plug the USB keyboard cable into the USB port located on the rear panel of your computer.

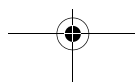
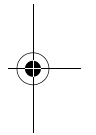
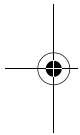
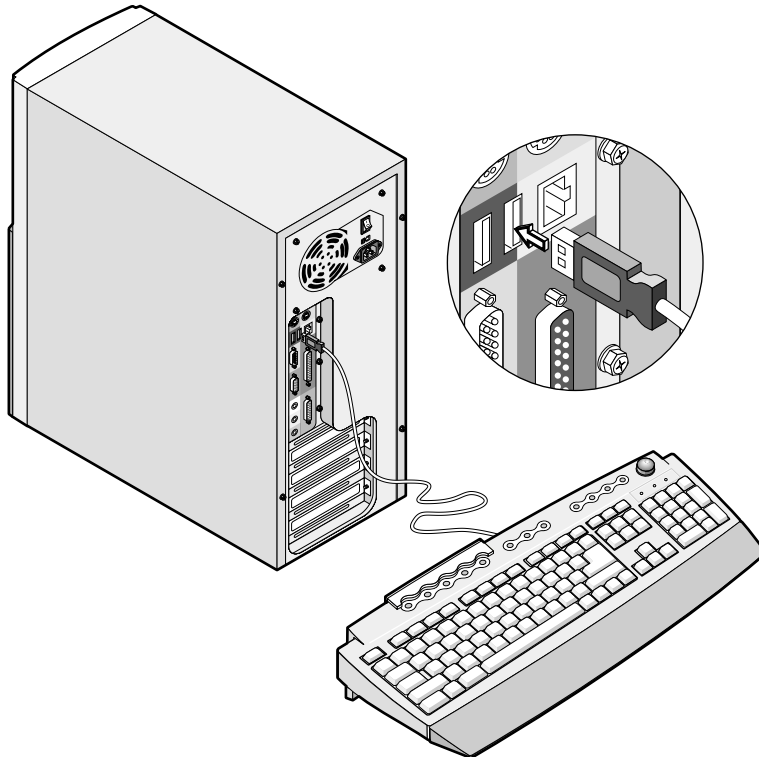

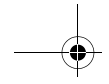

Monitor

To connect a monitor, simply plug the monitor cable into the external monitor port located on the rear panel of your computer.

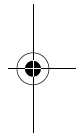
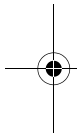
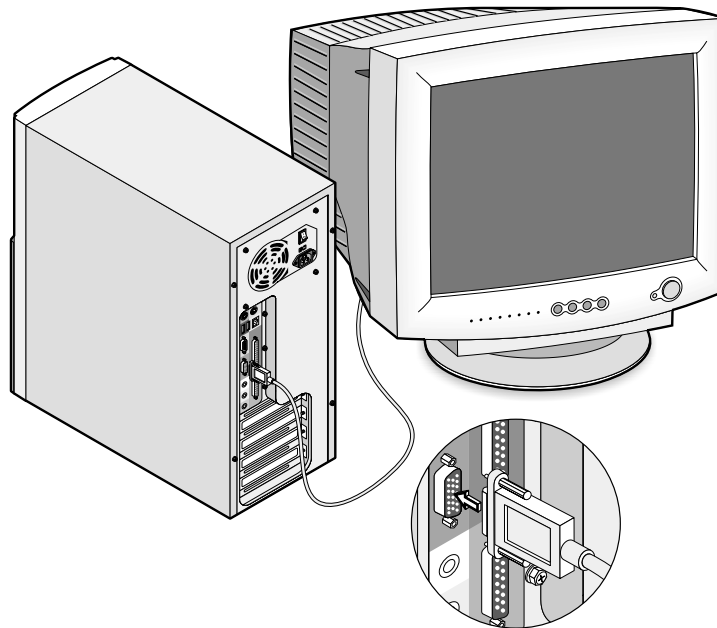

Note: Refer to the monitor manual for additional instructions and information.

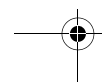
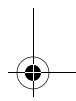
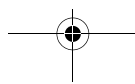
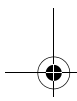



Power cable



Caution: Before you proceed, check the voltage range in your area. Make sure that it matches your computer's voltage setting (see the voltage setting switch located on the rear panel of your computer). If they don't match, change your computer's voltage setting according to your area's voltage range.

Plug the power cable into the power cable socket located on the rear panel of your computer. Then plug the other end of the power cable into a power outlet.

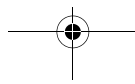
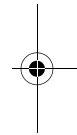
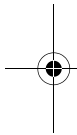
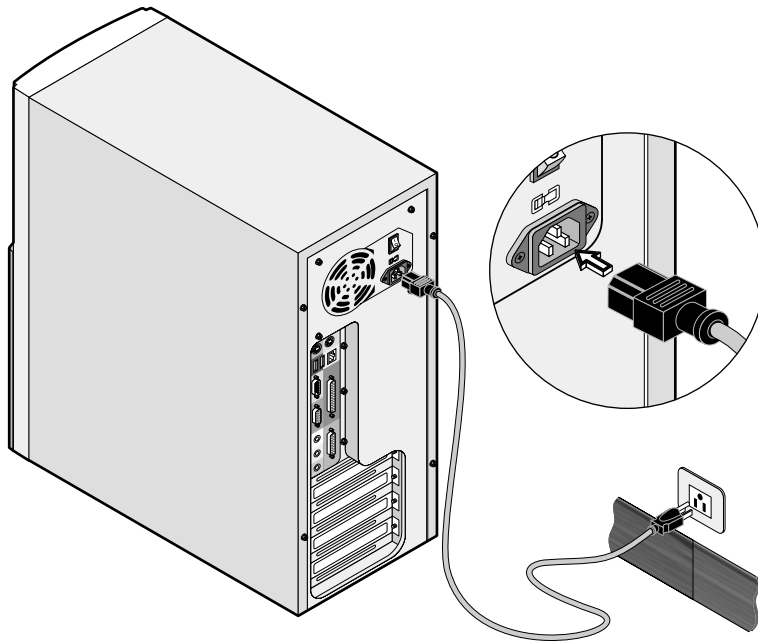

Connecting options

Printer

Your computer supports both serial and parallel printers.

To connect a parallel printer, plug the printer cable into the parallel port located on the rear panel of your computer.

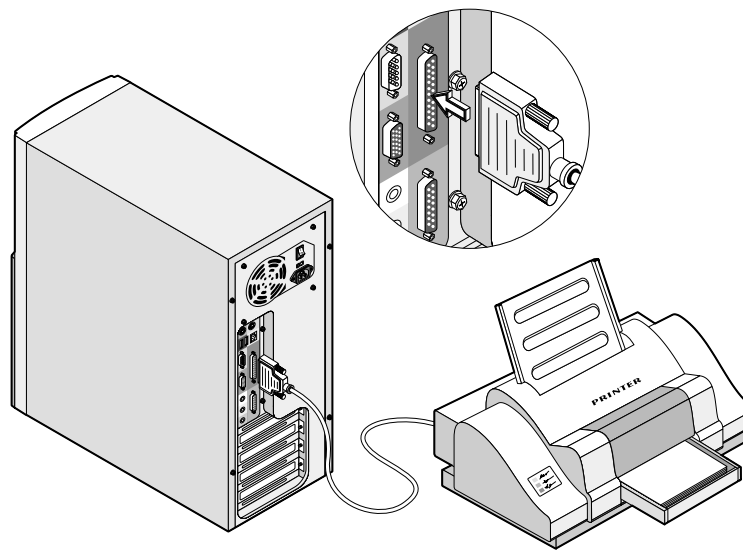

To connect a serial printer, plug the printer cable into either serial port 1 or serial port 2 located on the rear panel of your computer. See "Rear panel" on page 11 for the location of the serial ports.

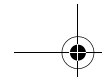

Network

You can connect your computer to a Local Area Network (LAN) using a network cable. To do so, simply plug the network cable into the network port on the rear panel of your computer.

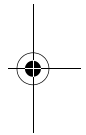
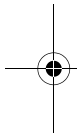
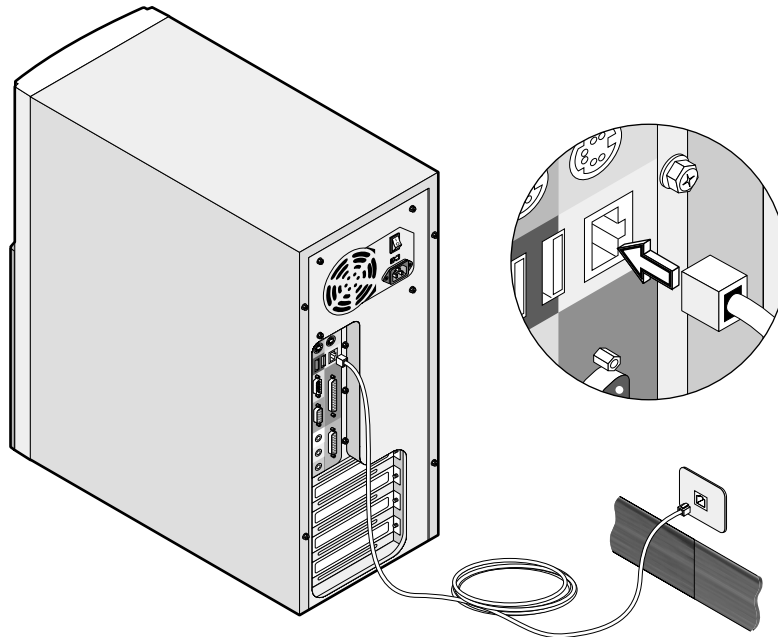

Note: Consult your operating system manual for information on how to configure your network setup.

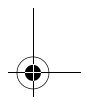
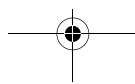
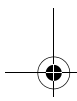

Modem



Note: A modem connection is only available when you have a modem card installed in your system. Contact your dealer for more information.

Set up your modem connection by plugging the telephone line and handset into their correspond ports on the rear panel of your computer.

Refer to the figure below for the connections.

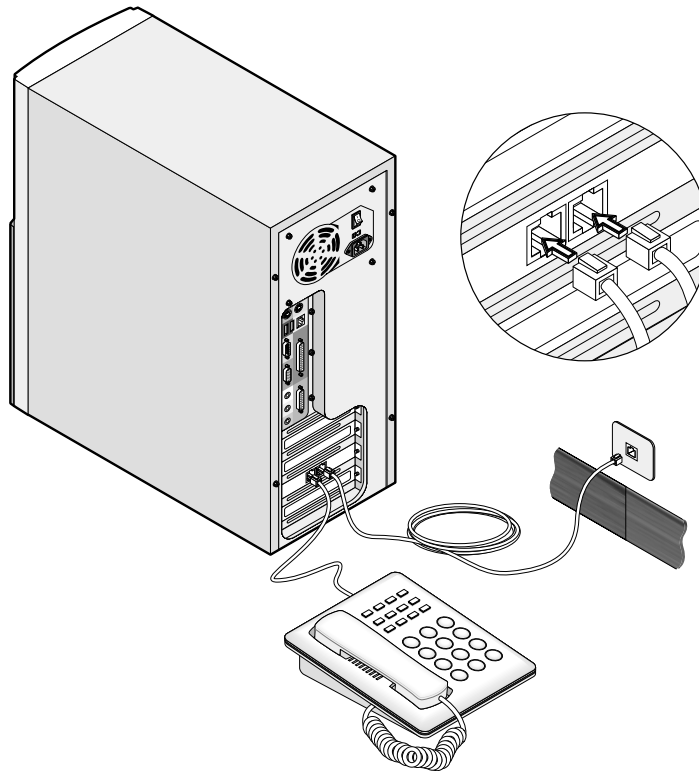

Multimedia devices

You can connect multimedia devices such as speakers, a microphone, headphones or earphones and a joystick (for games). These devices will allow you to take advantage of your computer's multimedia features.

Plug the devices in as follows:

- microphone: connect to Mic-in port
- speakers, earphones, headphones: connect to Audio-out/Line-out port
- external CD player: connect to Audio-in/Line-in port
- joystick: connect to Game/MIDI port

Refer to the figure below for the connections.

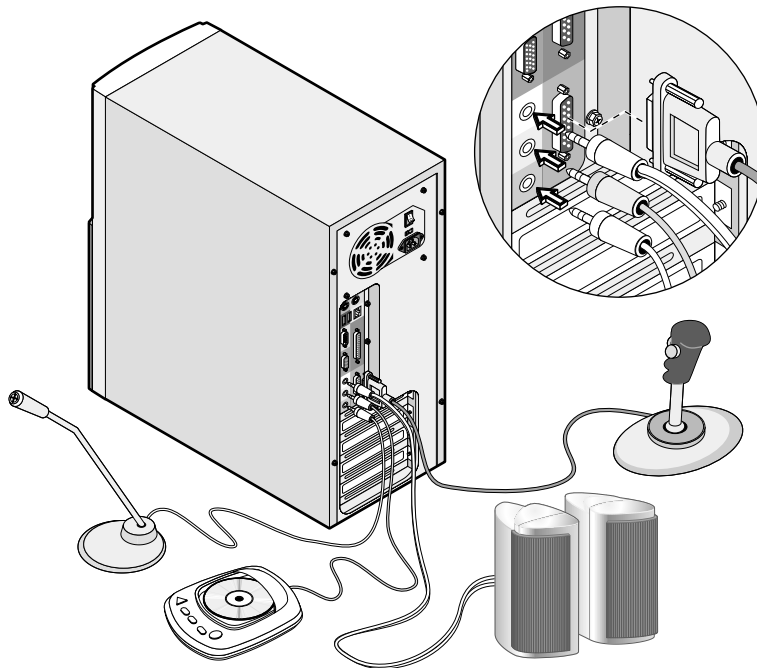

Note: For information on how to configure the multimedia devices, consult the documentation that came with each device.

USB devices

Universal Serial Bus (USB) is a new serial bus design that is capable of cascading low-/medium-speed peripherals (less than 12 Mbps) such as a keyboard, mouse, joystick, scanner, printer and modem. With USB, complex cable connections can be eliminated.

Your computer comes with two USB ports located on the rear panel. These ports allow you to connect additional serial devices to your computer without using up its system resources.

To connect a USB device, simply plug the device cable into either of the USB ports.

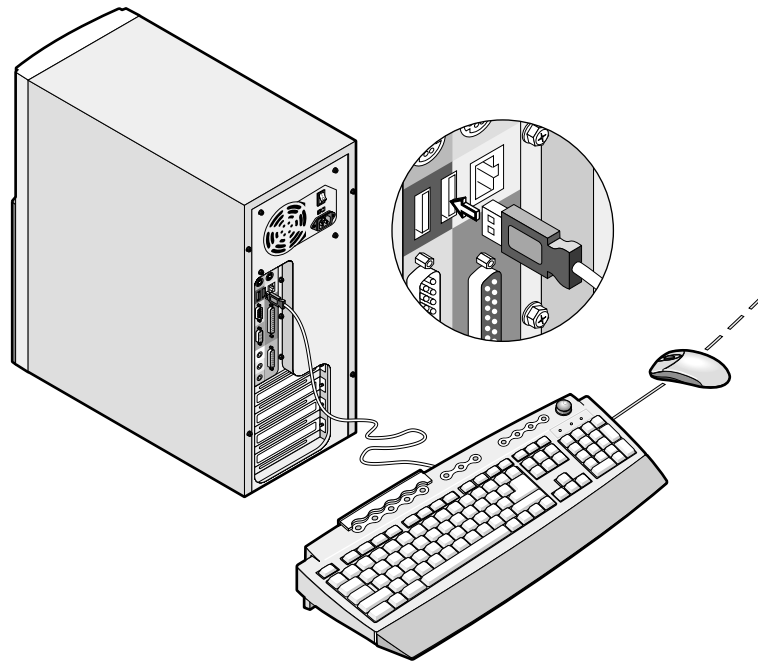

Note: Most USB devices have a built-in USB port which allows you to daisy-chain other devices.

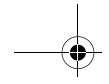

Turning on your computer

After connecting the necessary peripherals and plugging in the power cable, you are now ready to turn the computer on and get to work.

To turn on your computer:

- 1** Turn on all peripherals connected to your computer such as the monitor, printer, fax, speakers, etc.
- 2** Locate and turn on the main power switch on the rear panel of your computer.

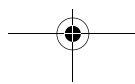
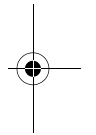
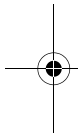
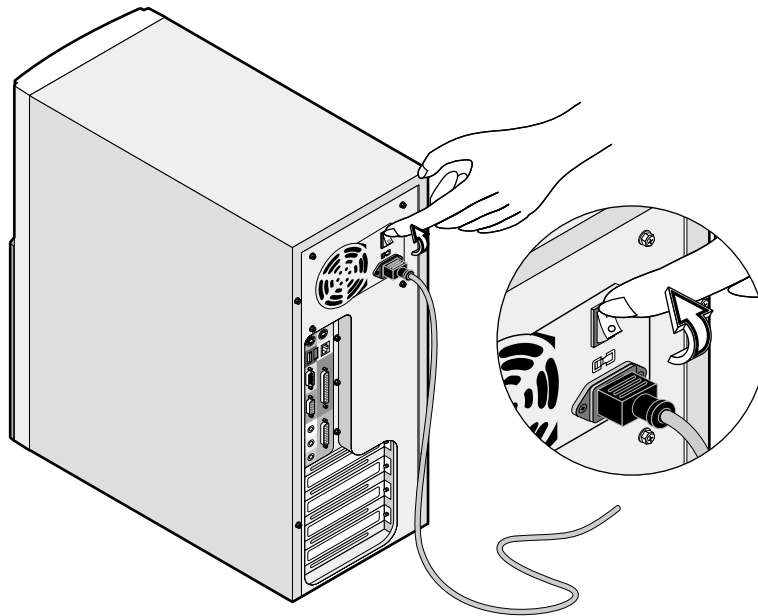

- 3 On the front panel of your computer, press the power button.

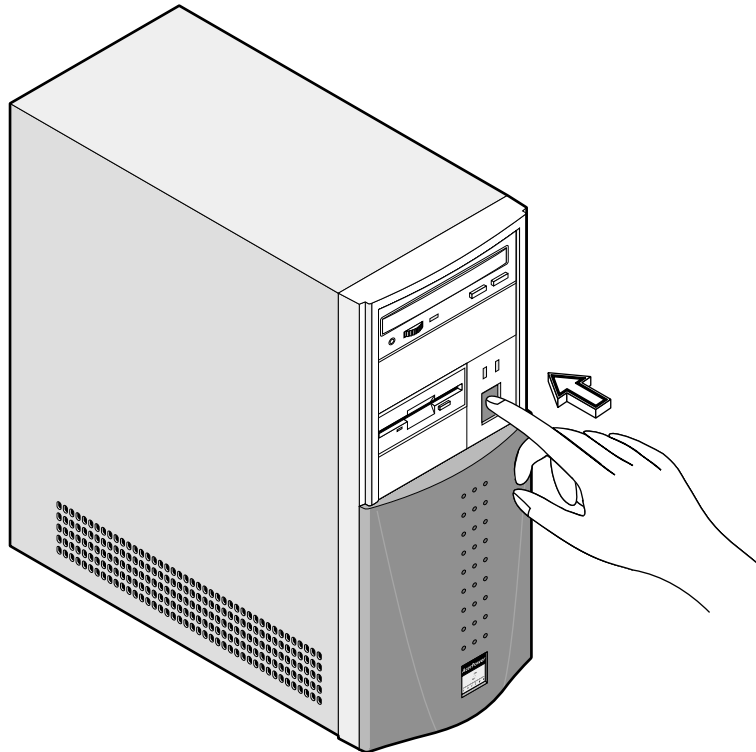

When the computer finishes booting, it is now ready for use.



.....
Important! Make sure that the power cable is properly plugged into an electrical outlet. If you are using a power strip or an AVR (Auto-Voltage Regulator), make sure that it is plugged in and turned on.



Turning off your computer

To turn off your computer, do either of the following:

- From your Windows desktop, click on **Start, Shut Down...** and select **Shut down**; then click on **OK**.
- Turn off all peripherals connected to your computer, and then, press the power button for at least four seconds. Quickly pressing the button may put the computer in Suspend mode only.



.....
Note: You do not need to turn off the main power switch every time you turn off your computer. Turn off the main power switch only if:

- you will not use your computer for a long time or
- your computer needs servicing.

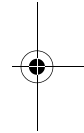
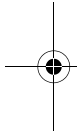

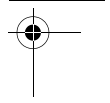
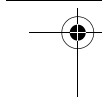
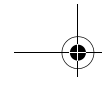

4 Upgrading your computer

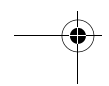
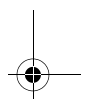
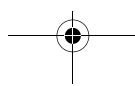
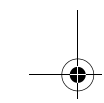
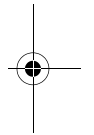
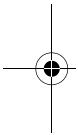

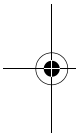
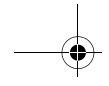

This chapter contains instructions on how to upgrade your computer and basic information about your system board that you will find helpful when performing the upgrade process.

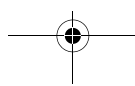
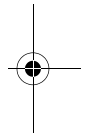



Installation precautions

Before you install any system component, we recommend that you read the following sections. These sections contain important ESD precautions along with preinstallation and post-installation instructions.

ESD precautions

Electrostatic discharge (ESD) can damage your processor, disk drives, expansion boards, and other components. Always observe the following precautions before you install a system component:

- 1 Do not remove a component from its protective packaging until you are ready to install it.
- 2 Wear a wrist grounding strap and attach it to a metal part of the system unit before handling components. If a wrist strap is not available, maintain contact with the system unit throughout any procedure requiring ESD protection.

Preinstallation instructions

Always observe the following before you install any component:

- 1 Turn off your computer and all the peripherals connected to it before opening it. Then unplug all cables from the power outlets.
- 2 Open your computer according to the instructions on "Opening your computer" on page 41.
- 3 Follow the ESD precautions described above before handling a system component.
- 4 Remove any expansion boards or peripherals that block access to the DIMM sockets or component connector.
- 5 See the following sections for specific instructions on the component you wish to install.



.....
Warning! Not turning off the computer properly before you start installing the components may cause serious damage.

Do not attempt the procedures described in the following sections unless you are a qualified service technician.

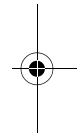
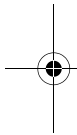

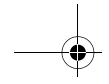

Post-installation instructions

Observe the following after installing a system component:

- 1** See to it that the components are installed according to the step-by-step instructions in their respective sections.
- 2** Make sure you have set all the required jumpers. See "Mainboard" on page 45 for the correct jumper settings.
- 3** Replace any expansion boards or peripherals that you removed earlier.
- 4** Replace the computer cover.
- 5** Connect the necessary cables and turn on your computer.

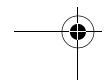
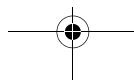
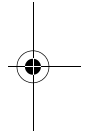
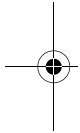

Opening your computer



Caution: Before you proceed, make sure that you have turned off your computer and all peripherals connected to it. Read the "Preinstallation instructions" on page 39.

You need to open your computer before you can install additional components. See the following section for instructions.

Removing the cover

- 1 Turn off the system power and unplug all cables.
- 2 Place the system unit on a flat, steady surface.
- 3 Remove the four screws from the rear panel. Set the screws aside. You will need them when replacing the housing cover.

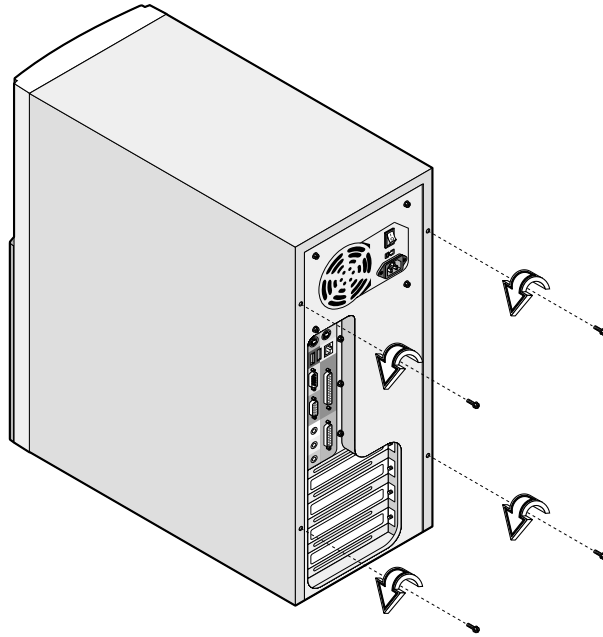

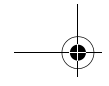

- 4 Push the housing cover slightly backward, then pull it upward to remove it from the chassis.

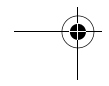
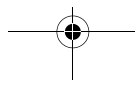
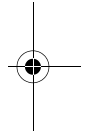
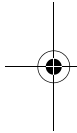
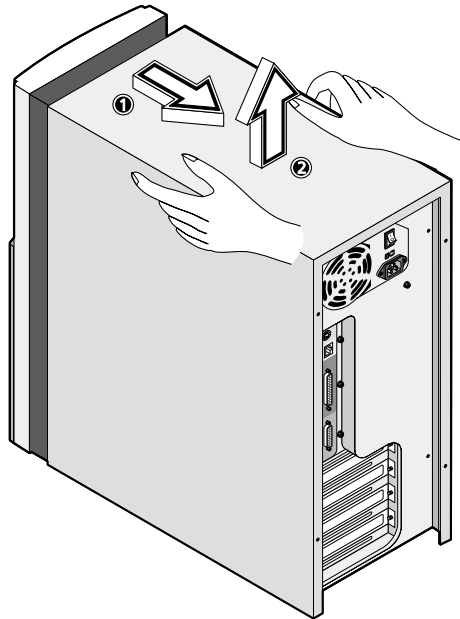

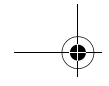

Replacing the cover

- 1 Replace the housing cover.

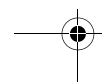
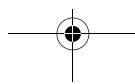
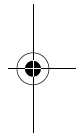
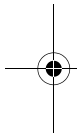
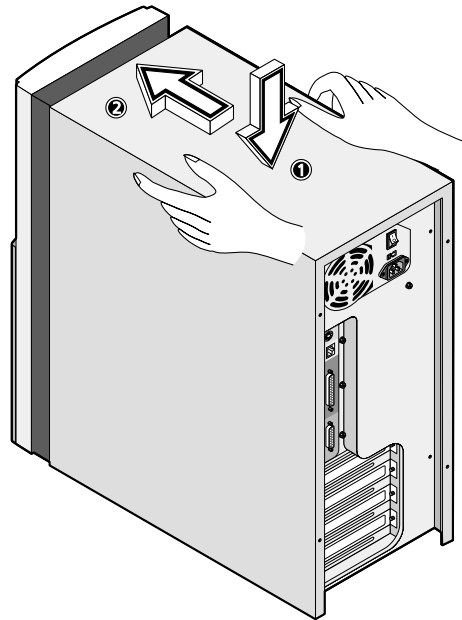

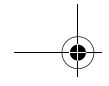

2 Secure the housing cover with the necessary screws.

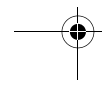
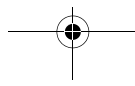
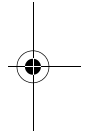
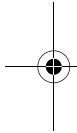
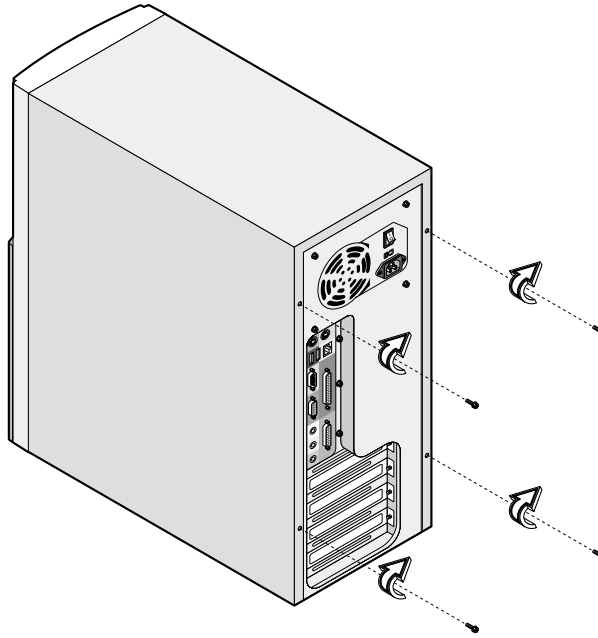

Mainboard

The layout below shows all the connectors and jumpers of the mainboard. Refer to the table for a brief description of each connectors and jumpers.

The mainboard becomes accessible once you open your computer. It should look like the figure shown below:

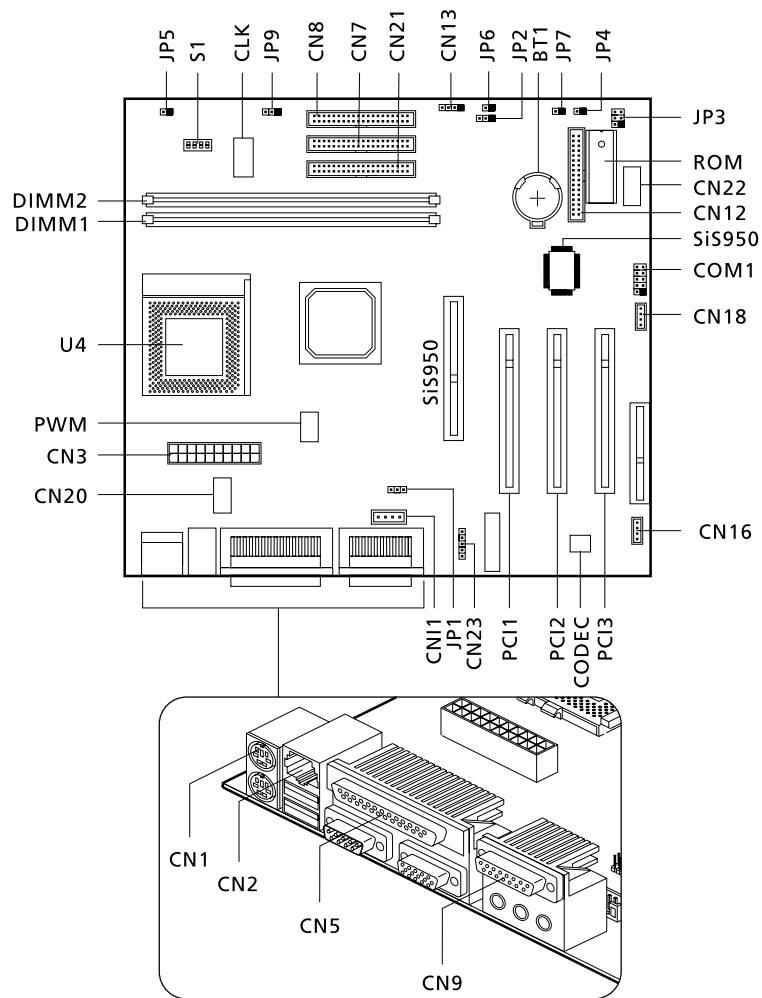



:

Connector	Description
CN1	PS/2 connectors
CN2	USB/LAN connectors
CN3	ATX power connector
CN5	Printer/VGA/COM2 connectors
CN7	IDE2 connector
CN8	IDE1 connector
CN9	Game/MIDI port
CN10	12-pin AC'97 connector
CN11	Audio CD connector
CN12	FDD connector
CN13	HDD LED connector
CN16	Fax voice modem connector
CN18	Wake-on LAN c onnector
CN20	RF connector
CN21	Slim CD-ROM connector
CN22	Optional USB ports
CN23	Audio-in connector
JP1	1-2: Disable onboard Codec 2-3: Enable onboard Codec
JP2	Power LED connector
JP3	1-2 and 4-5: 4M flash ROM 2-3 and 5-6: 2M flash ROM
JP4	Reset connector
JP5	Intrusion
JP6	LAN LED connector

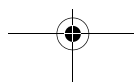
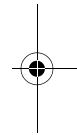
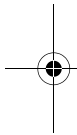



Connector	Description
JP7	Power switch connector
JP9	1-2: set CN21 as slave 2-3: set CN21 as Master

CPU frequency table

S4	S3	S2	S1	CPU	SDRAM
0	0	0	0	66	100
0	0	0	1	100	100
0	0	1	0	150	100
0	0	1	1	133	100
0	1	0	1	100	133
0	1	1	0	100	150
0	1	1	1	133	133
1	0	0	0	66	66

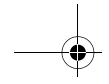

Installing additional memory

The two 168-pin sockets onboard support Synchronous Dynamic Random-Access Memory (SDRAM)-type DIMMs. You may install 32-MB, 64-MB, 128-MB, 256-MB, or 512-MB (single and double density) DIMMs for a maximum of 1-GB memory.

The SDRAM DIMMs should work under 3.3 volts only; 5-volt memory devices are not supported. This system board supports both PC-100 (100MHz) and PC-133 (133 MHz) SDRAM. However, they cannot be used at the same time in a computer. Please contact your dealer for qualified DIMM vendors.



Caution: Do not use both PC-100 (100 MHz) and PC-133 (133 MHz) SDRAM together. Such a combination might cause your system to malfunction.

Each of the DIMM sockets is independent from the others. This independence allows you to install DIMMs with different capacities to form different configurations.

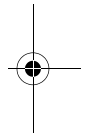
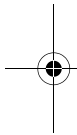

Installing a DIMM

- 1 Open the clips on the socket.
- 2 Align the DIMM with the socket.
- 3 Press the DIMM into the socket until the clips lock onto the DIMM.

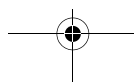
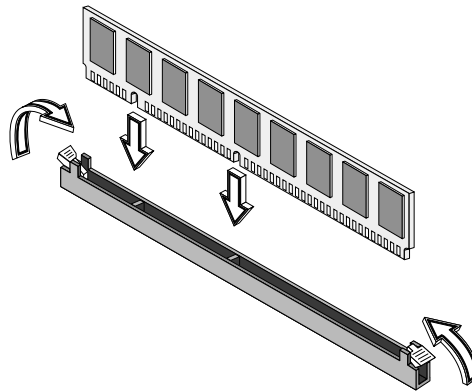



Note: The DIMM socket is slotted to ensure proper installation. If you insert a DIMM but it does not fit easily into the socket, you may have inserted it incorrectly. Turn the DIMM around and try to insert it again.

Removing a DIMM

- 1 Press the holding clips on both sides of the socket outward to release the DIMM.
- 2 Gently pull the DIMM out of the socket.

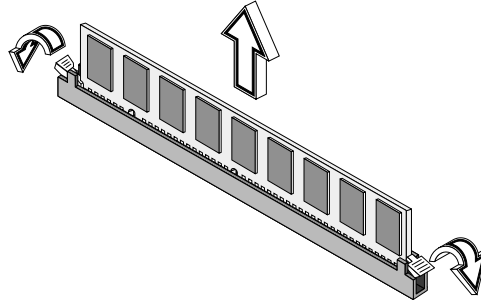

Reconfiguring your computer

Your computer automatically detects the amount of memory installed. Run Setup to view the new value for total system memory and make a note of it. For more information about the Setup Utility, refer to the "Setup Utility" in the online manual.



Upgrading the CPU

This system board supports Pentium III and Celeron processors and future Intel processors. Both connects to a 370-pin socket form factor instead of the slot connector form factor.



Note: Observe the ESD precautions when installing or removing a system component. See section "Installation precautions" on page 39.

Follow these steps to upgrade your CPU:

- 1 Remove the cover as shown on page 41.
- 2 Disconnect the 3-pin and 2-pin fan/heatsink cables from the system board.
- 3 Unhook one side of the fan/heatsink metal bracket and gently lift it before removing the other side.
- 4 Gently push the socket lever down to release the lever and then pull it up to remove the CPU.
- 5 Insert the new CPU. Make sure that pin 1 (indicated by a notched corner) of the CPU connects to hole 1 of the socket.

Push down the socket lever to lock the new CPU into the socket.

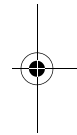
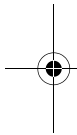
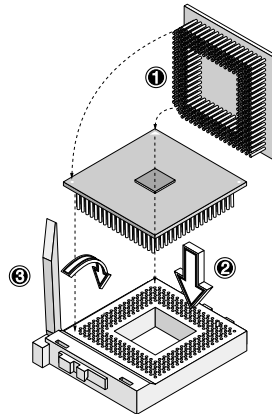

- 6 Attach one side of the fan/heatsink metal bracket to the CPU socket and then gently push down the other side of the metal bracket until it locks in place.

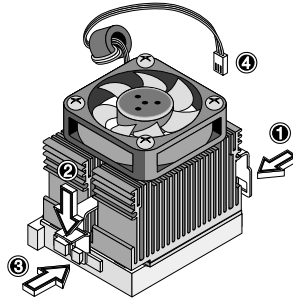

- 7 Connect the 3-pin and 2-pin fan/heatsink cables to the system board. Refer to "Mainboard" on page 45 for the location of the fan/heatsink connectors.



.....
Note: The heatsink becomes very hot when the system is on.
NEVER touch the heatsink with any metal or with your hands.

- 8 Reinstall the housing cover as instructed on page 43.

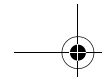

Replacing the hard disk

Follow these steps to replace the hard disk drive:

- 1** Remove the cover as shown on page 41.
- 2** Disconnect all cables connected to the hard disk and 3.5-inch floppy disk drives.

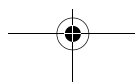
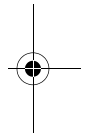
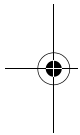
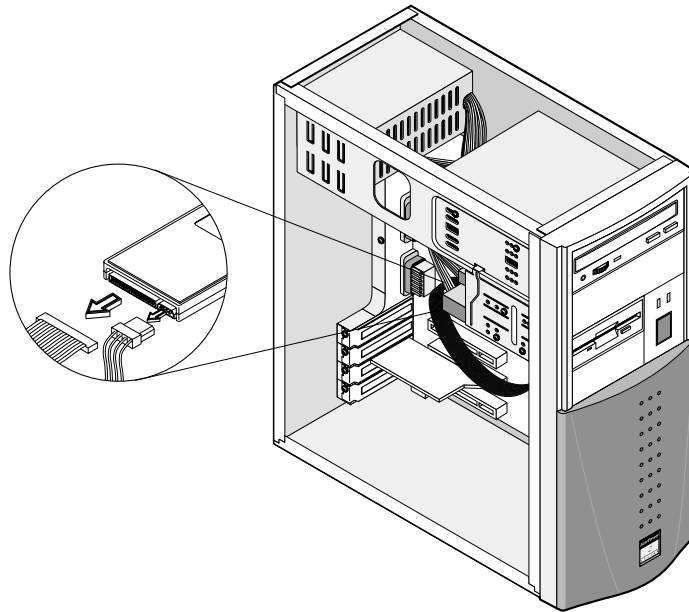

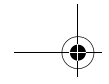

- 3 Remove the 3.5-inch drive frame from the housing by pressing the tab on top and pivoting the frame outward.

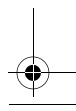
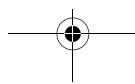
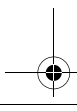
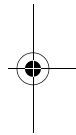
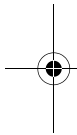
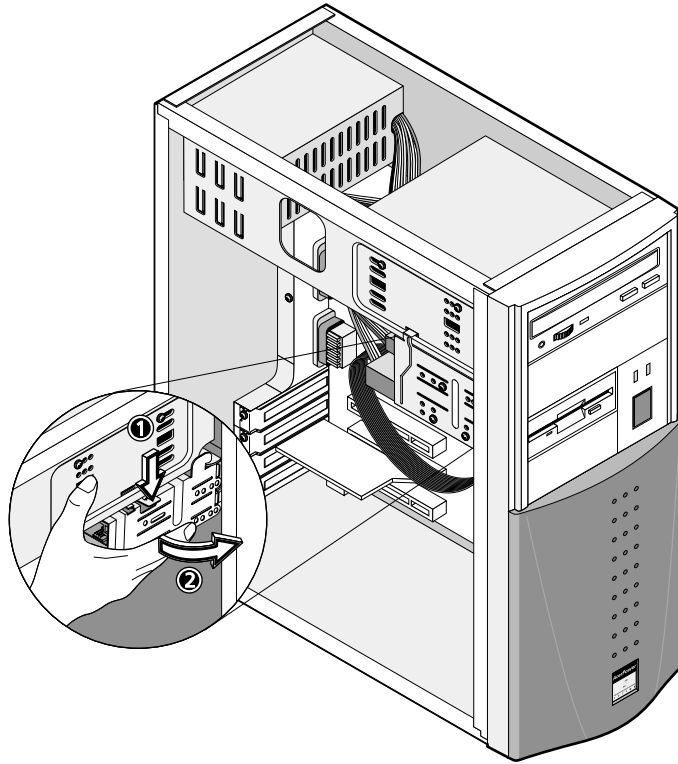

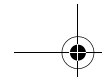

- 4** Remove the four screws that hold the hard disk to the drive frame and pull out the hard disk drive.

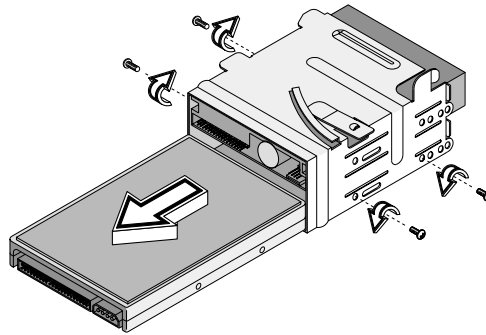

- 5** Install a new 3.5-inch hard disk drive and secure it with the four screws that you have removed previously.

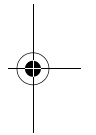
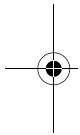
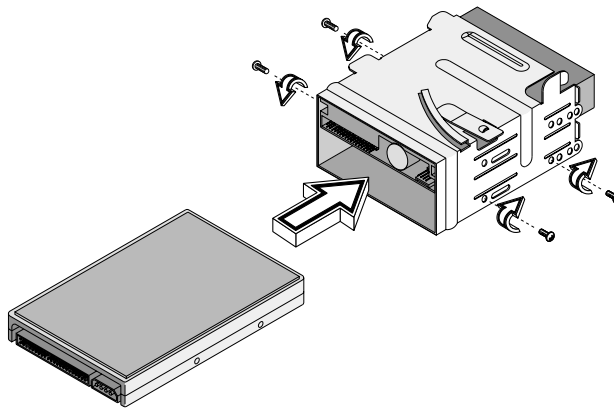

- 6** Reinstall the frame into the housing as in the following figure:
 - a** Align the frame with the notch.

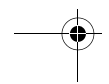
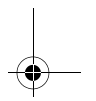
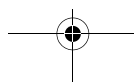
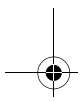

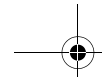

- b** Pivot the frame toward the housing until the tab clicks into place.

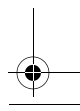
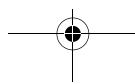
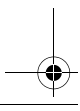
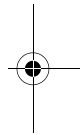
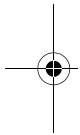
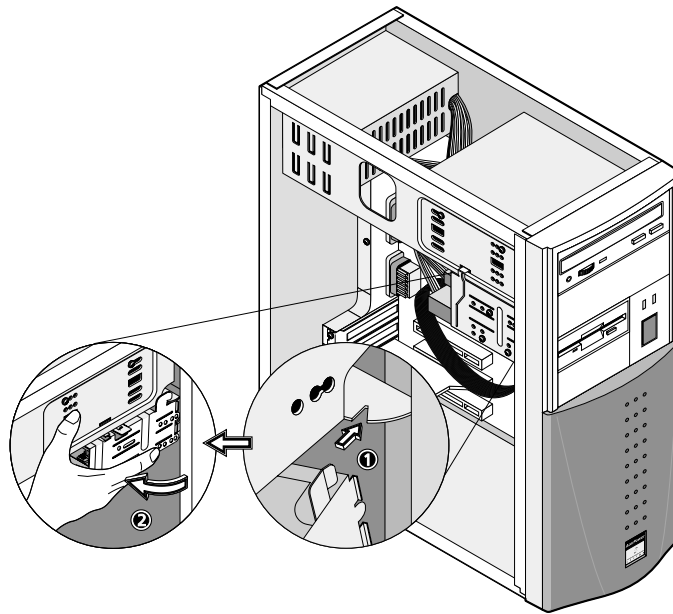

- c Connect the disk drive cables and power cables.

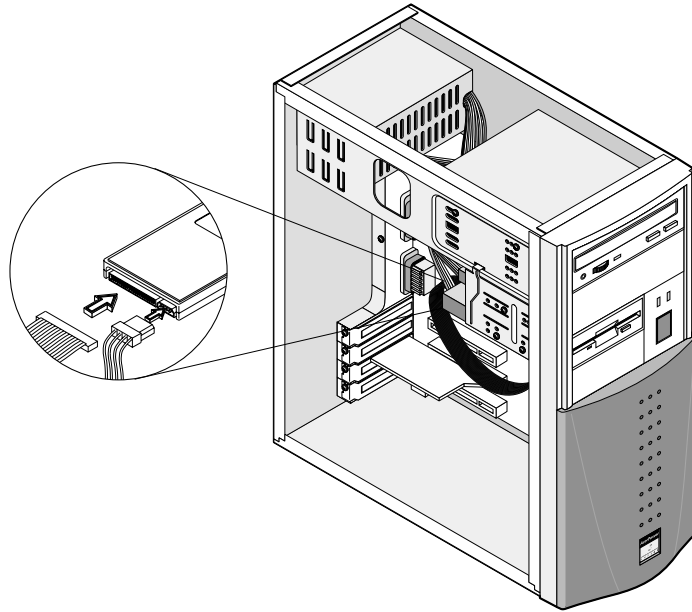

Note: Make sure that the other ends of the floppy disk drive cables are connected to their corresponding connectors on the system board.

- 7 Reinstall the housing cover as instructed on page 43.

Installing an expansion card

On your mainboard, you will find empty slots. These slots allow you to install expansion cards to further upgrade your computer.

To install an expansion card:

- 1** Remove the cover as shown on page 41.
- 2** Locate an empty PCI slot on the system board.
- 3** Remove the bracket on the housing opposite the selected empty slot.
- 4** Remove the PCI card from its protective packaging.
- 5** Align then insert the PCI card into the slot. Make sure that the card is properly seated.

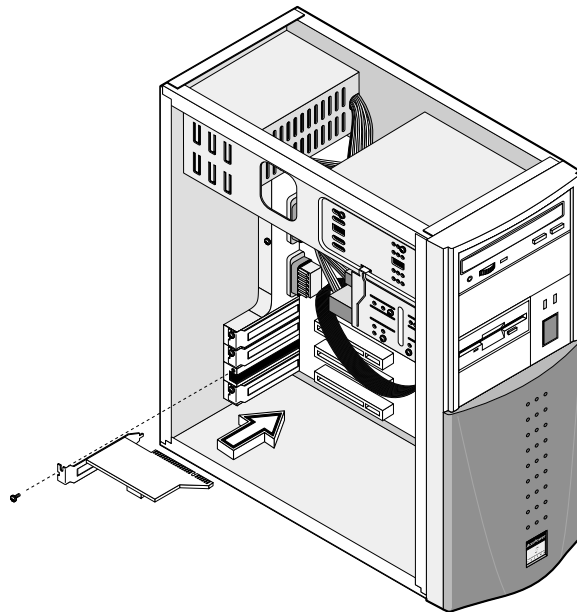

- 6** Secure the card to the housing with a screw.
- 7** Reinstall the housing cover (see page 43).

When you turn on the system, BIOS automatically detects and assigns resources to the PCI devices.

