

AcerPower

8400

User's Guide

Copyright 1999 Acer Incorporated
All Rights Reserved. Printed in Taiwan

Changes may be made periodically to the information in this publication without obligation to notify any person of such revision or changes. Such changes will be incorporated in new editions of this manual or supplementary documents and publications. This company makes no representations or warranties, either expressed or implied, with respect to the contents hereof and specifically disclaims the implied warranties of merchantability or fitness for a particular purpose.

Record the model number, serial number, purchase date, and place of purchase information in the space provided below. The serial number and model number are recorded on the label affixed to your computer. All correspondence concerning your unit should include the serial number, model number, and purchase information.

No part of this publication may be reproduced, stored in a retrieval system, or transmitted, in any form or by any means, electronic, mechanical, photocopy, recording, or otherwise, without the prior written permission of Acer Incorporated.

All trademarks, registered trademarks and/or service marks are the properties of their respective owners.

Notices

FCC Notice

This device has been tested and found to comply with the limits for a Class B digital device pursuant to Part 15 of the FCC Rules. These limits are designed to provide reasonable protection against harmful interference in a residential installation. This device generates, uses, and can radiate radio frequency energy and, if not installed and used in accordance with the instructions, may cause harmful interference to radio communications.

However, there is no guarantee that interference will not occur in a particular installation. If this device does cause harmful interference to radio or television reception, which can be determined by turning the device off and on, the user is encouraged to try to correct the interference by one or more of the following measures:

- Reorient or relocate the receiving antenna
- Increase the separation between the device and receiver
- Connect the device into an outlet on a circuit different from that to which the receiver is connected
- Consult the dealer or an experienced radio/television technician for help

Notice: Shield Cables

All connections to other computing devices must be made using shielded cables to maintain compliance with FCC regulations.

Notice: Peripheral Devices

Only peripherals (input/output devices, terminals, printers, etc.) certified to comply with the Class B limits may be attached to this equipment. Operation with noncertified peripherals is likely to result in interference to radio and TV reception.

Caution

Changes or modifications not expressly approved by the manufacturer could void the user's authority, which is granted by the Federal Communications Commission, to operate this computer.

Use Conditions

This part complies with Part 15 of the FCC Rules. Operation is subject to the following two conditions: (1) this device may not cause harmful interference, and (2) this device must accept any interference received, including interference that may cause undesired operation.

Notice: Canadian Users

This Class B digital apparatus meets all requirements of the Canadian Interference-Causing Equipment Regulations.

Remarque à l'intention des utilisateurs canadiens

Cet appareil numérique de la classe B respecte toutes les exigences du Règlement sur le matériel brouilleur du Canada.

Important Safety Instructions

Read these instructions carefully. Save these instructions for future reference.

- 1.** Follow all warnings and instructions marked on the product.
- 2.** Unplug this product from the wall outlet before cleaning. Do not use liquid cleaners or aerosol cleaners. Use a damp cloth for cleaning.
- 3.** Do not use this product near water.
- 4.** Do not place this product on an unstable cart, stand, or table. The product may fall, causing serious damage to the product.
- 5.** Slots and openings in the cabinet and the back or bottom are provided for ventilation; to ensure reliable operation of the product and to protect it from overheating, these openings must not be blocked or covered. The openings should never be blocked by placing the product on a bed, sofa, rug, or other similar surface. This product should never be placed near or over a radiator or heat register, or in a built-in installation unless proper ventilation is provided.
- 6.** This product should be operated from the type of power indicated on the marking label. If you are not sure of the type of power available, consult your dealer or local power company.
- 7.** Do not allow anything to rest on the power cord. Do not locate this product where persons will walk on the cord.
- 8.** If an extension cord is used with this product, make sure that the total ampere rating of the equipment plugged into the extension

cord does not exceed the extension cord ampere rating. Also, make sure that the total rating of all products plugged into the wall outlet does not exceed the fuse rating.

- 9.** Never push objects of any kind into this product through cabinet slots as they may touch dangerous voltage points or short out parts that could result in a fire or electric shock. Never spill liquid of any kind on the product.
- 10.** Do not attempt to service this product yourself, as opening or removing covers may expose you to dangerous voltage points or other risks. Refer all servicing to qualified service personnel.
- 11.** Unplug this product from the wall outlet and refer servicing to qualified service personnel under the following conditions:
 - a.** When the power cord or plug is damaged or frayed
 - b.** If liquid has been spilled into the product
 - c.** If the product has been exposed to rain or water
 - d.** If the product does not operate normally when the operating instructions are followed. Adjust only those controls that are covered by the operating instructions since improper adjustment of other controls may result in damage and will often require extensive work by a qualified technician to restore the product to normal condition.
 - e.** If the product has been dropped or the cabinet has been damaged
 - f.** If the product exhibits a distinct change in performance, indicating a need for service.
- 12.** Replace the battery with the same type as the product's battery we recommend. Use of another battery may present a risk of fire or explosion. Refer battery replacement to a qualified serviceman.
- 13.** Warning! Battery may explode if not handled properly. Do not recharge, disassemble or dispose of in fire. Keep away from children and dispose of used batteries promptly.
- 14.** Use only the proper type of power supply cord set (provided in your keyboard/manual accessories box) for this unit. It should be a detachable type: UL listed/CSA certified, type SVT/SJT, rated 6A 125V minimum, VDE approved or its equivalent. Maximum length is 15 feet (4.6 meters).

Year 2000 Compliance Statement

The AcerPower 8400 carries the "Hardware NSTL Tested Year 2000 Compliant" logo, which certifies that this model has been tested by NSTL using the YMark2000 test, and has been found to meet NSTL's standards for Year 2000 hardware compliance.



For more details, check the Acer Year 2000 Resource Center at <http://www.acer.com.tw/service/y2k/>

Laser Compliance Statement

The CD-ROM drive in this computer is a laser product. The CD-ROM drive's classification label (shown below) is located on the drive.

CLASS 1 LASER PRODUCT

CAUTION: INVISIBLE LASER RADIATION WHEN OPEN.
AVOID EXPOSURE TO BEAM.

APPAREIL A LASER DE CLASSE 1 PRODUIT

LASERATTENTION: RADIATION DU FAISCEAU LASER
INVISIBLE EN CAS D'OUVERTURE. EVITER TOUTE
EXPOSITION AUX RAYONS.

LUOKAN 1 LASERLÄITE LASER KLASSE 1

VORSICHT: UNSICHTBARE LASERSTRAHLUNG, WENN
ABDECKUNG GEÖFFNET NICHT DEM STRAHL AUSSETZEN

PRODUCTO LÁSER DE LA CLASE I

ADVERTENCIA: RADIACIÓN LÁSER INVISIBLE AL SER
ABIERTO. EVITE EXPONERSE A LOS RAYOS.

ADVARSEL: LASERSTRÅLING VEDÅBNING SE IKKE IND I
STRÅLEN.

VARO! LAVATTAESSA OLET ALTTINA LASERSÄTEILYLLE.

VARNING: LASERSTRÅLNING NÄR DENNA DEL ÄR ÖPPNAD
ÅLÄ TUIJOTA SÄTEESEENSTIRRA EJ IN I STRÅLEN

VARNING: LASERSTRÅLNING NÄR DENNA DEL ÄR
ÖPPNADSTIRRA EJ IN I STRÅLEN

ADVARSEL: LASERSTRÅLING NÄR DEKSEL ÄPNESSTIRR IKKE INN I
STRÅLEN

Table of Contents

Notices	iii
Chapter 1 Getting Started	1
Overview	3
Preinstallation	4
Selecting a Site	4
Unpacking Components	4
Features	5
Front Panel	5
Rear Panel	6
Internal Components	7
Connecting System Components	8
Connecting the Keyboard	8
Connecting the Monitor	9
Connecting the Mouse	9
Connecting the Printer (optional)	10
Connecting Multimedia Components	11
Connecting to the Network (optional)	12
Connecting USB Devices (optional)	13
Turning On Your Computer	14
Turning Off Your Computer	16
Troubleshooting	17
Error Messages	19
Software Error Messages	19
System Error Messages	19
Correcting Error Conditions	21
Chapter 2 System Board Information	23
Features	25
Board Layout	26
Jumpers and Connectors	27
Panel Connector	27
Jumper Setting	28
Connector Description	28
Hard Disk Support	30
Audio Function	31
USB Support	32
Hardware Monitoring Function	33
Wake-on Modem Function	34

Wake-on LAN Function	35
Chapter 3 Award BIOS	37
Entering Setup	40
Standard CMOS Setup	41
BIOS Features Setup	44
Chipset Features Setup	49
DRAM Clock Table	51
Power Management Setup	53
Power Management Mode Table	57
PnP/PCI Configuration	58
Load Setup Defaults	61
Product Information	62
Integrated Peripherals	63
Password Setting	67
IDE HDD Auto Detection	68
Save & Exit Setup	69
Exit without Saving	70
Chapter 4 Upgrading the System	71
Installation Precautions	73
ESD Precautions	73
Preinstallation Instructions	73
Postinstallation Instructions	74
Opening the System	75
Removing the Housing Cover	75
Replacing the Housing Cover	76
Installing Additional Memory	77
Installing a DIMM	78
Removing a DIMM	79
Reconfiguring the System	79
Upgrading the CPU	80
Removing the CPU	80
Installing the CPU	82
Replacing the Hard Disk	84
Installing PCI and AGP Expansion Cards	87

Getting Started

Chapter 1

This chapter gives you a general introduction to the system unit and tells you how to select a site and set up the system. It also includes a simple troubleshooting section to help you check your system before you ask for technical support.

Overview

The AcerPower 8400 is an all-in-one, high-performance system that supports the Intel Pentium III CPU. It utilizes the PCI (Peripheral Component Interface) and the AGP (Accelerated Graphics Port) bus designs. Both designs improve system performance, enabling the system to support various multimedia functions and applications. In addition, the system board supports a jumper-less design that automatically detects the CPU voltage and frequency.

Aside from the standard I/O (Input/Output) interfaces such as two serial ports, one parallel port, and PS/2 keyboard and mouse ports, the system also comes with two USB (Universal Serial Bus) ports, one mono Microphone-in port, one stereo Line-in port, one Line-out port, and one Game/MIDI (Musical Instrument Digital Interface) port. These additional ports are included to enable the system to accommodate additional peripherals.

The system may also come with an onboard audio controller, a fax/modem card and/or a network card. These additional features offer special functions that will enable you to take full advantage of the system. Special features such as hardware monitoring, USB, power management, video and audio functions are discussed in this manual.

Furthermore, this system is fully compatible with MS-DOS v6.X, SCO UNIX, Windows 95/98 and Windows NT operating systems.



If you made some changes in the CMOS settings (BIOS) and your system fails to boot, do the following:

- 1. Hold down the **HOME** key while you reboot your system.*
- 2. When the system boots up, enter Setup by pressing **Ctrl-Alt-Esc**. The BIOS Setup main menu appears.*
- 3. Choose **Load Setup Defaults** to undo the changes you made and set the BIOS setup parameters to their original settings.*

Preinstallation

The preinstallation process involves the following activities:

- Selecting a site
- Unpacking components

Selecting a Site

Consider the following when selecting a site for your computer:

- Determine the best site for your system. Cable paths should not run near equipment that might cause electromagnetic or radio frequency interference such as radio transmitters, televisions, copy machines, or heating and air-conditioning equipment.
- Route cables away from personnel and equipment traffic.
- Avoid dusty areas and extremes of temperature and humidity.

Unpacking Components

Unpack the contents of each box carefully. Save all packing materials in case you need to move or ship the system in the future.

Check that all items are present and in good condition. Contact your dealer immediately if anything is missing or damaged.

Features

The basic configuration consists of a system unit, a keyboard, a CD-ROM drive, a diskette drive, a fixed disk drive and a mouse.

Front Panel

The figure below shows the system unit front panel.

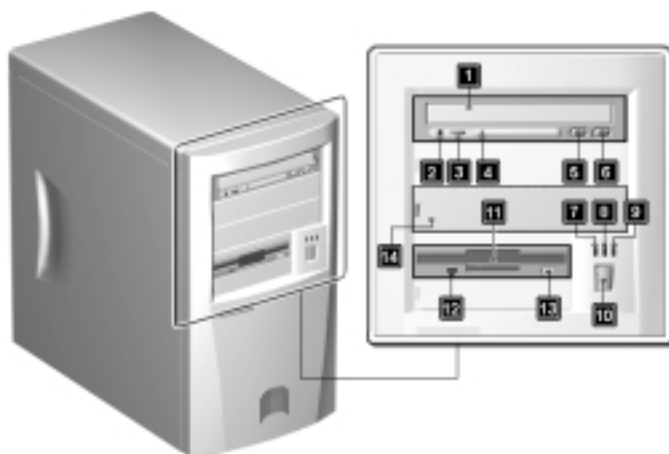

No.	Component	No.	Component
1	CD-ROM tray	8	Turbo LED
2	Headphone/Earphone port	9	Power/Suspend LED
3	Volume Control	10	Power button
4	CD-ROM LED	11	3.5-inch diskette drive
5	Play/Forward button	12	3.5-inch diskette drive LED
6	Stop/Eject button	13	3.5-inch diskette drive eject button
7	Hard Disk/Message LED	14	Empty drive bay

Rear Panel

The figure below shows the system unit rear panel.

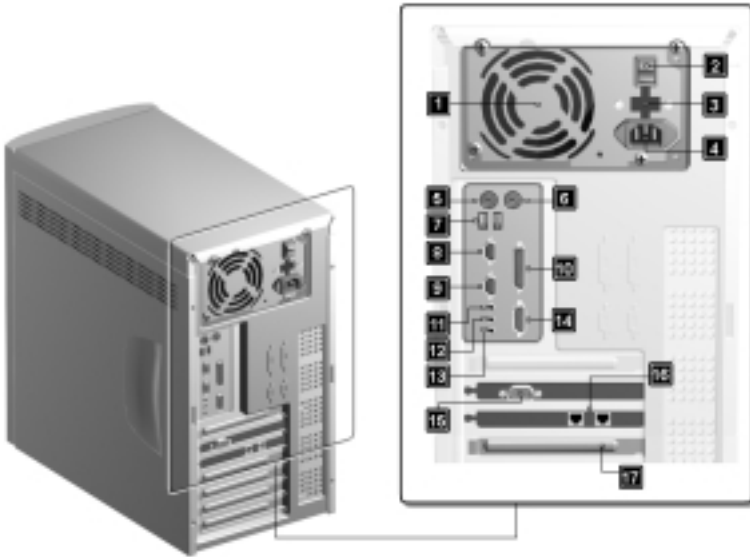

No.	Component	No.	Component
1	Fan	10	Parallel port
2	System main power switch	11	Speaker-out/Audio-out port
3	Voltage selector	12	Audio-in port
4	System power socket	13	Microphone-in port
5	PS/2 keyboard port	14	Game/MIDI port
6	PS/2 mouse port	15	VGA/Monitor port
7	USB ports	16	Modem port
8	Serial port 1	17	Add-on card brackets
9	Serial port 2		

Internal Components

The figure below shows the system unit internal components.

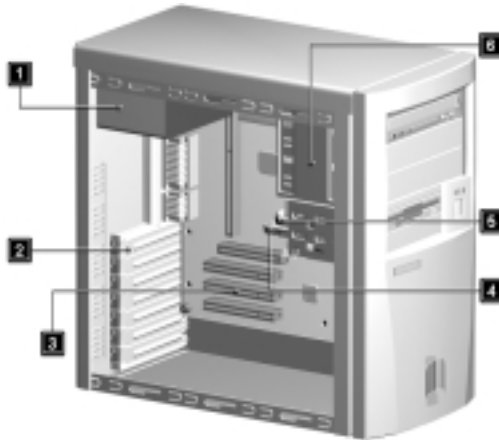

No.	Component	No.	Component
1	Power supply	4	Hard disk drive
2	Add-on card brackets	5	Floppy disk drive
3	PCI sockets	6	5.25-inch device drive bays

Connecting System Components



Caution: Do not turn on the system main power switch on the rear panel of the system or plug the system in until you finish connecting all system components.

The following sections show how to connect each component to the system:

Connecting the Keyboard

Plug the keyboard cable into the keyboard socket on the rear panel.

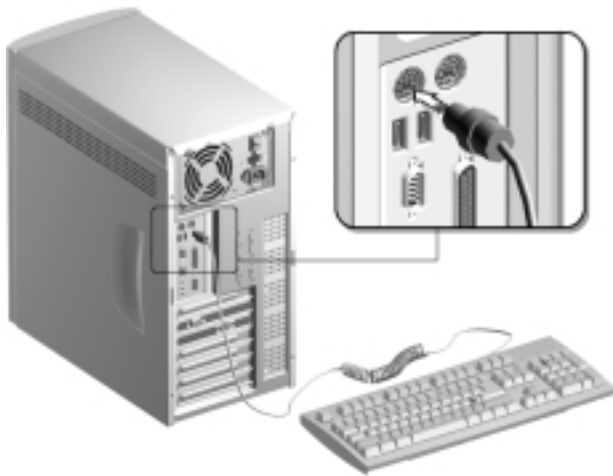

Connecting the Monitor

Plug the monitor signal cable into the VGA connector on the rear panel.

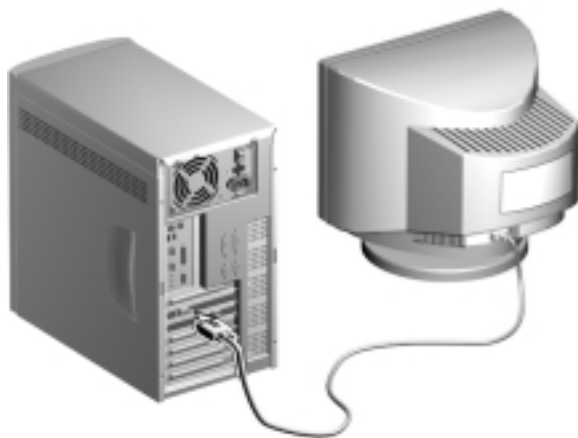

Connecting the Mouse

Plug the mouse cable into the mouse connector on the rear panel.



Connecting the Printer (optional)

Check your printer before you connect it to your system. If you have a parallel printer, connect it to the parallel port on the rear panel.

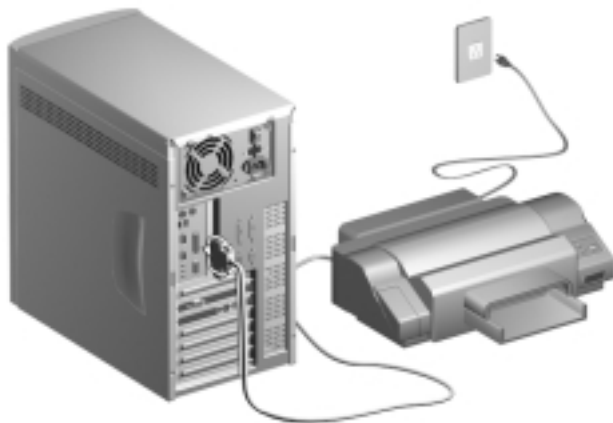

If you have a serial printer or other serial peripheral, connect it to the serial port (COM2). See “Rear Panel” on page 6 for the location of the serial ports.

Connecting Multimedia Components

Your system also supports optional multimedia features. Connect the multimedia components as shown below:

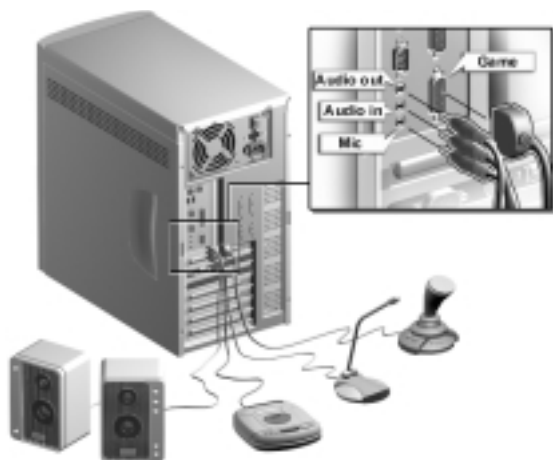

Connecting to the Network (optional)

Your system may come with a LAN (Local Area Network) card for network connection. To connect your system to the network, plug the network cable into the card's network port.

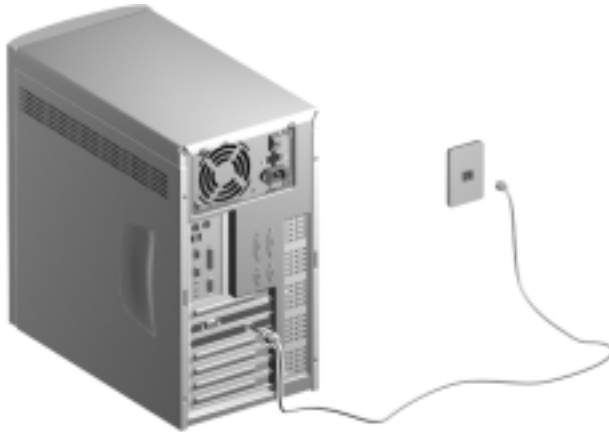

Connecting USB Devices (optional)

The USB ports on the rear panel enable the system to support additional serial devices without using up your system resources.

To connect a USB device, simply plug the device cable into a USB port on the rear panel.



Note: Most USB devices have a built-in USB port which allows you to daisy-chain other devices.

Turning On Your Computer

After you have connected all peripherals and cables, follow these steps to turn on your computer:

1. Turn on all peripherals connected to the system such as the monitor, printer, fax, speakers, etc.
2. Locate the system main power switch on the back of the system and turn it on.



3. Press the power button located on the front of the system unit.



When the system finishes booting, the computer is ready for use.

Turning Off Your Computer

1. Turn off all peripherals connected to the system such as the monitor, printer, fax, speakers, etc.
2. Press the power button located on the front of the system unit for at least four seconds. Quickly pressing the button puts the system in Suspend mode only.



Note: *You do not need to turn off the system main power switch on the rear panel every time you turn off your computer.*

Turn off the system main power switch only if:

- *you will not use your system for a long period of time or*
- *you need to open your system for any purpose, such as troubleshooting or upgrading.*

If the system main power switch is not available, you must unplug the system.

Troubleshooting

If you encounter a hardware problem, we recommend that you review the following suggestions before calling for service:

General failure

- Are all cables securely plugged?
- Are all system components and peripherals turned on?
- Is the system main power switch on?
- Is the power outlet burned out? You may check this by plugging in and turning on some other piece of equipment.
- Are any cables damaged? Are they properly routed and coiled? Entwined cables may cause signal interference.

Front panel light doesn't work

- After turning off the computer, check inside the system unit and make sure that the front panel LED connector for the LED that is not working is correctly plugged. Refer to "Jumpers and Connectors" on page 27 to identify the proper LED connector.

"Garbage" or nothing appears on the screen

- Is the monitor turned on? Is the screen brightness adjusted properly?



.....

Warning! Never open the monitor case. The CRT monitor retains very high voltage levels even after the power is turned off. Refer all monitor service to qualified service technicians.

Keyboard is dead

- Is the keyboard cable plugged in? Turn off the system and plug in the keyboard.



.....

Caution: Do not plug or unplug the keyboard while the power is on.

Printer doesn't work

- Is the printer power turned off?
- Is the printer cable connected to the correct port (serial or parallel)?
- Are your application and the printer configured for the same operating values? Be sure there is no conflict with any port on the add-on card. For details, check the documentation that came with your printer.
- Is the printer out of paper or jammed? Check the printer's status indicator lights.
- Are the printer cables tangled? To prevent signal interference, neatly fold or coil excess cable length.

Add-on card fails intermittently

- Do two add-on cards have conflicting addresses? "PnP/PCI Configuration" on page 58 shows where you can see the addresses in the BIOS Setup screen.

If you receive an error message

- Read the corrective actions listed in "Error Messages" on page 19.

Error Messages

In the event that you receive an error message, do not continue using the computer. Note the message and take corrective action immediately. This section describes the different types of error messages and suggests corrective measures.

There are two general types of error messages:

- Software
- System

Software Error Messages

Software error messages are returned by your operating system or application. These messages typically appear after you boot the operating system or when you run your applications. If you receive this type of message, consult your application or operating system manual for help.

System Error Messages

A system error message indicates a problem with the computer itself. These messages normally appear during the power-on self-test, before the operating system prompt appears.

The table below lists the system error messages.

Error Message	Corrective Action
BIOS ROM checksum error	Bios ROM failed. Contact your dealer or an authorized service center.
CMOS battery failed	CMOS battery is out of power. Please change the system battery. For the location of the system battery, refer to page 26 or contact your dealer or an authorized service center.

Error Message	Corrective Action
CMOS Checksum Error - Defaults loaded	CMOS checksum error during post process. Press "F1" to ignore it or press Ctrl-Alt-Esc to enter cmos setup utility.
Conflict I/O Ports	Conflict in I/O resource settings detected. Contact your dealer or an authorized service center.
DISK BOOT FAILURE, INSERT SYSTEM DISK AND PRESS ENTER	There is no bootable floppy disk and hard disks detected. Please insert a bootable floppy disk into floppy drive.
Floppy disk(s) fail ()	No floppy disk detected. Set the Halt On parameter (see page 41) to either one of the settings except "All Errors" and "All, but keyboard". When the system encounters this error, it will not show this message.
Keyboard error or no keyboard present	No Keyboard detected. Set the Halt On parameter (see page 41) to either one of the settings except "All Errors" and "All, but diskette". When the system encounters this error, it will not show this message.
Memory test fail	System detects memory error during POST. Replace the SDRAM DIMMs or contact your dealer or an authorized service center.
Primary IDE channel no 80 conductor cable installed	System displays this message when you are using a UDMA66 hard disk with a 40 pins conductor cable.
Primary master hard disk fail	Primary master hard disk type mismatch between user's setting in STANDARD CMOS SETUP (see page 41) and what BIOS detected during POST.

Error Message	Corrective Action
Primary slave hard disk fail	Primary slave hard disk type mismatch between user's setting in STANDARD CMOS SETUP (see page 41) and what BIOS detected during POST.
Secondary IDE channel no 80 conductor cable installed	System displays this message when you are using a UDMA66 hard disk with a 40 pins conductor cable.
Secondary master hard disk fail	Secondary master hard disk type mismatch between user's setting in STANDARD CMOS SETUP (see page 41) and what BIOS detected during POST.
Secondary slave hard disk fail	Secondary master hard disk type mismatch between user's setting in STANDARD CMOS SETUP (see page 41) and what BIOS detected during POST.

Correcting Error Conditions

As a general rule, the "Press F1 to continue" error message is caused by a configuration problem which can be easily corrected. An equipment malfunction is more likely to cause a fatal error, i.e., an error that causes complete system failure.

Here are some corrective measures for error conditions:

1. Remove the system cover according to the directions in the system housing installation guide. Check that the system board and any expansion boards are set correctly.
2. Check that all connectors and boards are secure. Consult the system housing installation guide for assistance.

If you have purchased a new hard disk drive and your computer cannot detect it or access it after installing it, it may be because your disk is not physically formatted. Physically format the disk using the FDISK and FORMAT commands.



.....

Caution: *These commands are performed in DOS. We recommend that you familiarize yourself with the DOS commands first before you format your hard disk.*

If you follow the corrective steps above and still receive an error message, the cause may be an equipment malfunction.

If you are sure that your configuration values are correct and your battery is in good condition, the problem may lie in a damaged or defective chip. Contact an authorized service center for assistance.



.....

Note: *If you do not know how to contact an authorized service center, call your distributor.*

System Board Information

Chapter 2

This system board is uniquely-designed to support not only the common features found in today's high-performance system boards, but the multimedia functions as well.

This chapter gives a detailed discussion of the board's components and features.

Features

This high-performance system board comes with the following features:

- Intel Pentium III processor with 512-KB second-level cache running at 450, 500, 533, 550, or 600 MHz
- Three 168-pin DIMM sockets that accept 32-, 64-, and 128-MB PC-100 (100 MHz) and PC-133 (133 MHz) SDRAM (Synchronous DRAM); allows 384-MB maximum system memory
- Award Plug-n-Play, 2Mbit flash ROM BIOS
- Enhanced PCI local bus IDE controller
- Onboard Audio CODEC chipset AD1881
- Two PCI enhanced IDE interfaces that support up to four IDE devices
- External ports
 - PS/2 keyboard and mouse ports
 - Two buffered high-speed serial ports
 - One parallel port that supports Standard Parallel Port (SPP)/Extended Capabilities Port (ECP)/Enhanced Parallel Port (EPP) modes
 - Two Universal Serial Bus (USB) ports
- Three PCI (Peripheral Component Interconnect) slots
- One AGP (Accelerated Graphic Port) slot
- Plug-and-Play
- Software Shutdown support for Windows 95/98
- Power Management
- Hardware Monitoring function
- Wake-on Modem function
- Wake-on LAN function

Board Layout

Your system board should look just like the following figure:

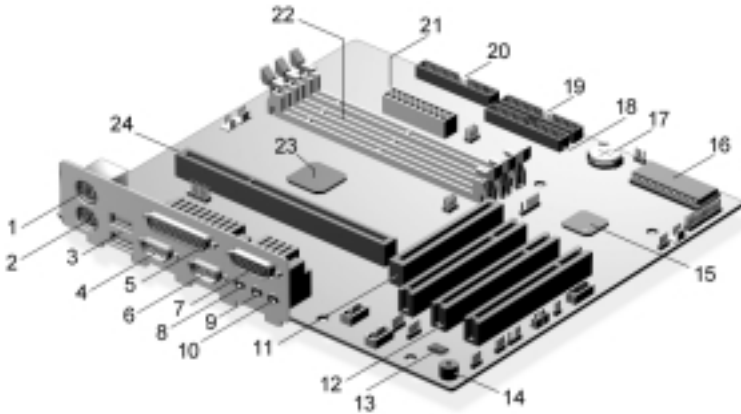

The following table lists the components that you will find on the system board:

No.	Component	No.	Component
1	PS/2 mouse port	13	AD1881 audio chipset
2	PS/2 keyboard port	14	Buzzer
3	USB ports	15	VIA VT82C686A chipset
4	Serial port 1	16	Award BIOS chipset
5	Parallel port	17	Battery
6	Serial port 2	18	IDE 2 connector
7	MIDI/Game port	19	IDE 1 connector
8	Speaker-out/Audio-out port	20	Floppy disk drive connector
9	Audio-in port	21	ATX power supply connector
10	Microphone-in port	22	DIMM sockets (three sockets)
11	AGP slot	23	VIA VT82C694X system controller
12	PCI slots (three slots)	24	CPU socket

Jumpers and Connectors

Refer to the following figure for the location of the jumpers and connectors on the system board:

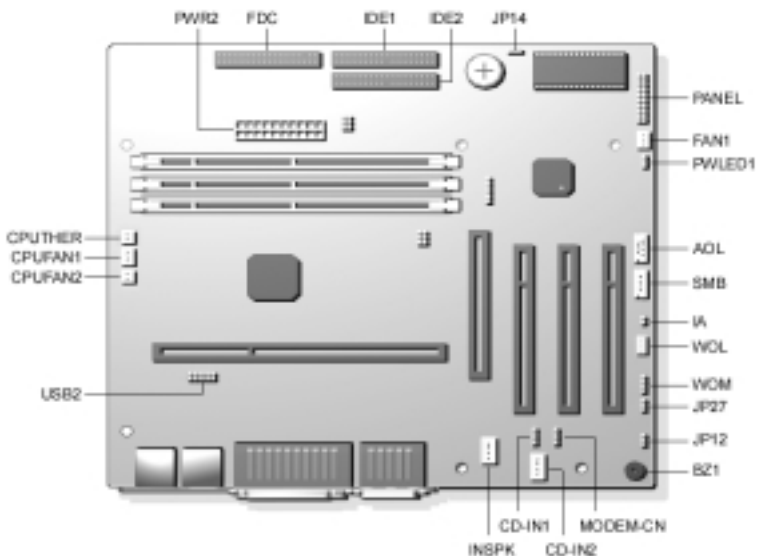

Panel Connector



NOTE: PWLED1 is a power LED connector for Aspire 6400 and AcerPower 4400. However, PWRLED in the PANEL, as shown below, is the one for AcerPower 8400.

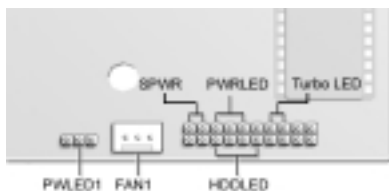

Jumper Setting

Jumper	Function and Settings
JP12	Sound
1-2	Enabled (default)
2-3	Disabled
JP14	CMOS Setting
1-2	Normal operation (default)
2-3	Clear CMOS
JP27	PC Beep Output
1-2	Onboard buzzer (default)
2-3	Line-out

Connector Description

Connector	Description
PWR2	ATX power connector
USB2	USB connector
FDC	Floppy drive connector
IDE1	IDE1 primary channel
IDE2	IDE2 secondary channel
CPUFAN1	3-pin CPU fan connector
CPUFAN2	2-pin CPU fan connector
CPUTHER	2-pin CPU Thermal detector connector
FAN1	Fan connector (reserved)
PANEL	Front panel (Multifunction) connector
CD-IN 1 and 2	CD-audio connector (Do not use both connectors at the same time)

Connector	Description
INSPK	Internal speaker connector (reserved)
MODEM-CN	Mono-in (Pin 1-2) and Mic-out (Pin 3-4)
BZ1	Onboard Buzzer
WOM	Wake-on-Modem connector (reserved)
WOL	Wake-on-LAN connector
SMB	SMBus connector
IA	Intrusion Alarm connector
AOL	Alert-on-LAN connector
SPWR*	Power switch connector

* Located in the PANEL connector.

Hard Disk Support

The board comes with an enhanced PCI IDE controller that supports PIO mode 4 and Ultra DMA (Direct Memory Access) mode data transfers. Two PCI IDE interfaces are mounted on the board to enable the system to support a maximum of four IDE hard disks, or any other IDE devices. See “Jumpers and Connectors” on page 27 for the location of the IDE interfaces.

Connect the cables according to the IDE hard disk configuration listed in the table below. Follow the instructions in the housing installation manual on how to install a hard disk in the system.

IDE Connector	Master	Slave
IDE 1	Hard disk 0	Hard disk 1
IDE 2	Hard disk 2/IDE CD-ROM	Hard disk 3

Audio Function

For its audio solution, the board comes with a PCI-based audio controller and the following ports:

- ❑ Mono microphone port
- ❑ Stereo line-in port
- ❑ Stereo line-out port
- ❑ Game/MIDI port

These connectors enable the system to accommodate external audio devices. For instructions on how to connect the external audio devices, see “Connecting Multimedia Components” on page 11.

USB Support

USB is a new serial bus design that is capable of cascading low and medium-speed peripherals (less than 12 Mbps) such as a keyboard, mouse, joystick, scanner, printer and modem/ISDN. With USB, complex cable connections at the back panel of your PC can be eliminated.

The board comes with two USB ports. See “Board Layout” on page 26 for the location of the ports.

Hardware Monitoring Function

The Hardware Monitoring function allows you to check the system resources, either locally or in a computer network, by using software such as Acer ADM (Advanced Desktop Manager). Acer ADM is a desktop management program that offers SMART (System Monitoring Analysis and Reporting Technology) for checking local or network connected systems. In addition, it also enables the PC hardware and applications to be OS (operating system) independent.

To enable the Hardware Monitoring function, you need to install Acer ADM. Contact your dealer for information on the availability of the software. Refer to the software documentation for more details on the Hardware Monitoring function.

Wake-on Modem Function

The Wake-on Modem function enables the system to resume from shutdown or suspend mode by monitoring the fax/modem (or any device of similar type) activities. Any signal or activity detected from the Modem Ring-in connector automatically returns the system to normal operation.

Wake-on LAN Function

This system board implements a WOL connector. To use the LAN Wake-up function, you need to install a network card that supports this feature. In addition, you also need to install a network management software such as ADM (Advanced Desktop Manager). This feature allows the system to be activated via network access. Common network functions such as remote access, file sharing, etc. are also supported. Refer to “Jumpers and Connectors” on page 27 for the location of the WOL connector on the system board.

Award BIOS

Chapter 3

This chapter contains detailed discussion about the Award BIOS utility. You will need this information for reconfiguring your system or for resetting your system back to its original settings in case you have reconfigured it improperly.

The Award BIOS utility is a hardware configuration program built into your system's Basic Input/Output System (BIOS). It supports a jumper-less design that automatically detects the CPU voltage and frequency.

If you made some changes in the CMOS settings (BIOS) and your system fails to boot, do the following:

1. Hold down the **HOME** key while you reboot your system.
2. When the system boots up, enter Setup by pressing **Ctrl-Alt-Esc**. The BIOS Setup main menu appears.
3. Choose **Load Setup Defaults** to undo the changes you made and set the BIOS setup parameters to their original settings.

Entering Setup

To enter Setup, press **Ctrl-Alt-Esc** during the POST (Power-on self-test). The “BIOS Setup” main menu then appears:



Note: Choose “Load Setup Defaults” for best performance with light system loading. Refer to “Load Setup Defaults” on page 61.

The section at the bottom of the screen tells how to control the screen. Use the **arrow keys** to move between items, **ESC** to exit, and **F10** to save the changes and exit. Another section at the bottom of the screen displays a brief description of the highlighted item. After selecting an item, press **Enter** to select it or enter a submenu.

The parameters on the screens show default values. These values may not be the same as those in your system.

The grayed items on the screens have fixed settings and are not user-configurable.

Standard CMOS Setup

The Standard CMOS Setup sets the basic system parameters such as the date, time, and the hard disk type. Use the arrow keys to highlight an item and **PgUp** or **PgDn** to select the value for each item.

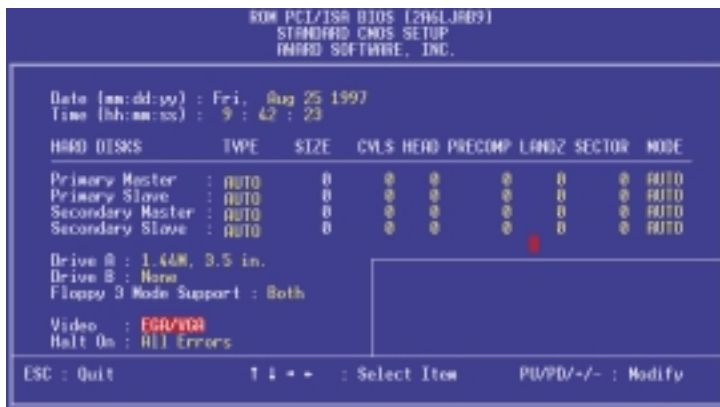

The table below describes each Standard CMOS Setup parameter. Settings in **boldface** are the default and suggested settings.

Parameter	Description	Format/Options
Date	Lets you set the date following the weekday-month-day-year format.	Weekday: Sun, Mon, Tue, Wed, Thu, Fri, Sat Month: Jan, Feb...Dec Day: 1 to 31 Year: 1980 to 2079
Time	Lets you set the time following the hour-minute-second format.	Hour: 0 to 23 Minute: 0 to 59 Second: 0 to 59

Parameter	Description	Format/Options
Hard Disk Type Primary Master Primary Slave Secondary Master Secondary Slave	This item lets you select the IDE hard disk parameters that your system supports. Auto enables BIOS to automatically detect the parameters of installed HDD during the POST (Power-on self-test). If you prefer to enter HDD parameters manually, select User. Select None if no HDD is connected to the system. The IDE CD-ROM is always automatically detected.	Auto User None
Hard Disk Mode Primary Master Primary Slave Secondary Master Secondary Slave	This enhanced IDE feature allows the system to use a hard disk with a capacity of more than 528MB. This is made possible through Logical Block Address (LBA) mode translation. LBA is now considered a standard feature of current IDE hard disks on the market because of its capability to support capacities larger than 528MB. Note that if your HDD is formatted with LBA On, it will not be able to boot with LBA Off.	Auto Normal LBA Large
Drive A	Allows you to configure your floppy drive A.	1.44 MB, 3.5-inch None 360 KB, 5.25-inch 1.2 MB, 5.25-inch 720 KB, 3.5-inch 2.88 MB, 3.5-inch

Parameter	Description	Format/Options
Drive B	Allows you to configure your floppy drive B.	None 360 KB, 5.25-inch 1.2 MB, 5.25-inch 720 KB, 3.5-inch 1.44 MB, 3.5-inch 2.88 MB, 3.5-inch
Floppy 3 Mode Support	Allows your floppy drive(s) to run in 3 modes including 2.88 MB mode.	Both Drive A Drive B Disabled
Video	This item specifies the type of video card in use. The default setting is VGA/EGA. Since current PCs use VGA only, this function is almost useless and may be disregarded in the future.	EGA/VGA CGA40 CGA80 Mono
Halt On	This parameter enables you to control the system stops in case of Power-on self-test (POST) errors.	All Errors No Errors All, But Keyboard All, But Diskette All, But Disk/Key

BIOS Features Setup



The table below describes the parameters found in this menu. Settings in **boldface** are the default and suggested settings.

Parameter	Description	Format/Options
CPU Internal Cache	Enabling this parameter activates the CPU internal cache. Disabling the parameter slows down the system.	Enabled Disabled
CPU L2 Cache ECC Checking	This item lets you enable or disable the L2 Cache ECC checking.	Disabled Enabled
Quick Power-On Self Test	This parameter speeds up POST by skipping some items that are normally checked.	Enabled Disabled

Parameter	Description	Format/Options
Boot Sequence	This parameter allows you to specify the system boot up search sequence. The hard disk IDs are listed below: C: Primary master D: Primary slave E: Secondary master F: Secondary slave LS: LS120 Zip: IOMEGA ZIP Drive	C,A,CDROM A,C,SCSI C,A,SCSI C,CDROM,A CDROM,C,A CDROM,A,C D,A,SCSI E,A,SCSI SCSI,A,C SCSI,C,A C only LS/ZIP,C
Silent Boot	This item is used to decide if the Aspire logo displays when the system boots up.	Enabled Disabled
Display Configuration Data	This item is used to decide if the configuration table displays when the system boots up.	Enabled Disabled
Swap Floppy Drive	This item allows you to swap floppy drives. For example, if you have two floppy drives (A and B), you can assign the first drive as drive B and the second drive as drive A or vice-versa.	Disabled Enabled
Boot Up Floppy Seek	When enabled, the BIOS issues the seek command to the floppy drive during POST to move the floppy drive head forward and backward.	Enabled Disabled

Parameter	Description	Format/Options
Boot Up NumLock Status	Setting this parameter to On enables the numeric function of the numeric keypad. Set this parameter to Off to disregard the function. Disabling the numeric function allows you to use the numeric keypad for cursor control.	On Off
Gate A20 Option	The settings for this parameter are Normal and Fast. If the data transfer is controlled by the 8042 chip, set the parameter to Normal. The Fast setting transfers the control to ASICs.	Fast Normal
Memory Parity/ECC Check	This item is used to enable or disable the parity/ECC check function.	Disabled Enabled
Typematic Rate Setting	When enabled, continually holding down a key on the keyboard will generate repeatedly keystrokes.	Disabled Enabled
Typematic Rate (Chars/Sec)	This item allows you to control the speed of repeated keystrokes.	6, 8, 10, 12, 15, 20, 24, and 30
Typematic Delay (Msec)	This parameter allows you to control the delay time (in milliseconds) between the first and the second keystroke (where the repeated keystrokes begin).	250, 500, 750, and 1000

Parameter	Description	Format/Options
Security Option	<p>The System option limits access to both the System boot and BIOS setup. A prompt asking you to enter your password appears on the screen every time you boot the system.</p> <p>The Setup option limits access only to BIOS setup.</p> <p>To disable the security option, select Password Setting from the main menu, don't type anything and just press Enter.</p>	<p>System Setup</p>
PCI/VGA Palette Snoop	<p>Enabling this item informs the PCI VGA card to keep silent (and to prevent conflict) when the palette register is updated (i.e., accepts data without responding to any communication signals). This is useful only when two display cards use the same palette address and are plugged into the PCI bus at the same time (such as MPEQ or Video capture). In such case, the PCI VGA is silent while the MPEQ/Video capture is set to function normally.</p>	<p>Disabled Enabled</p>
OS Select for DRAM > 64MB	<p>Set to OS/2 if your system is utilizing an OS/2 operating system and has a memory size of more than 64 MB.</p>	<p>Non-OS/2 OS/2</p>
Video BIOS Shadow	<p>VGA BIOS Shadowing means to copy video display card BIOS into the DRAM area. This enhances system performance because DRAM access time is faster than ROM.</p>	<p>Enabled Disabled</p>

Parameter	Description	Format/Options
C800-CBFF Shadow	These six items are for shadowing ROM code on other expansion cards. Before you set these parameters, you need to know the specific addresses of that ROM code. If you do not know this information, enable all the ROM shadow settings.	Disabled
CC00-CFFF Shadow		Enabled
D000-D3FF Shadow		
D400-D7FF Shadow		
D800-DBFF Shadow		
DC00-DFFF Shadow		

Chipset Features Setup



Caution: Make sure you fully understand the items contained in this menu before you try to change anything. You may change the parameter settings to improve system performance. However, changing these parameters could make your system unstable if the setting is not correct for your system configuration.

The table below describes the parameters found in this menu. Settings in **boldface** are the default and suggested settings.

Parameter	Description	Options
Bank 0/1 DRAM Timing	These items are used to set DRAM timing parameters which can be automatically set by BIOS.	SDRAM 10ns
Bank 2/3 DRAM Timing		SDRAM 8ns
Bank 4/5 DRAM Timing		Normal Medium Fast Turbo
SDRAM Cycle Length		3 2

Parameter	Description	Options
DRAM Clock	Please refer to the table on page 51 to set the DRAM clock.	CPU CLK CPU CLK +33 CPU CLK -33
Memory Hole	This option lets you reserve system memory area for special ISA cards. The chipset accesses code/data of these areas from the ISA bus directly. Normally, these areas are reserved for memory mapped I/O cards.	Disabled Enabled
Fast R-W Turn Around	Lets you configure the hard disk drive connected to the slave port of IDE channel 2.	Enabled Disabled
System BIOS Cacheable	Enabling this item allows you to cache the system BIOS to further enhance system performance.	Disabled Enabled
Video RAM Cacheable	This item lets you cache Video RAM A000 and B000.	Disabled Enabled
AGP Mode	If you are not sure which AGP mode to choose, simply select the highest AGP mode (4x) available. The system automatically downgrades to the proper mode.	4x 1x 2x
AGP Aperture Size (MB)	This item lets you determine the effective size of the AGP Graphic Aperture.	64 , 4, 8, 16, 32, and 128
CPU Micro Codes	The micro codes are used to fix bugs of the Pentium III CPU; we strongly recommend that you enable this item for system reliability reasons. However, these micro codes may slightly reduce CPU performance. We provide this option for your convenience if you would like to test it.	Enabled Disabled

Parameter	Description	Options
Clock Spread Spectrum	This item is used to set the clock spread spectrum for EMI testing. Normally, you don't need to change the default setting.	On Off
CPU Speed Detected	This motherboard can detect the CPU speed automatically and shows it in on this entry.	
CPU Clock Frequency	This item lets you set the external clock (bus clock). The correct setting may vary depending on your particular CPU. Refer to your CPU specifications for more details.	66.8 MHz 100 MHz 133 MHz
CPU Clock Ratio	The Intel Pentium III is designed to have a different Internal (Core) and External (Bus) frequency. This item lets you select the ratio of Core/Bus frequency.	1.5, 2.0, 2.5, 3.0, 3.5, 4.0, 4.5, 5.0, 5.5, 6.0, 6.5, 7.0, 7.5, and 8.0
Setup CPU Speed	The CPU Speed is derived from the product of "CPU Clock Frequency" and "CPU Clock Ratio".	



NOTE: The value in the Setup CPU Speed parameter may differ from the value in the CPU Speed Detected parameter. However, the actual running CPU speed shown is always the value in the CPU Speed Detected parameter.

DRAM Clock Table

CPU	SDRAM	Recommended Setting
133 MHz	PC133	CPU CLK
133 MHz	PC100	CPU CLK-33M
100 MHz	PC133	CPU CLK+33M

CPU	SDRAM	Recommended Setting
100 MHz	PC100	CPU CLK

Power Management Setup



The table below describes the parameters found in this menu. Settings in **boldface** are the default and suggested settings.

Parameter	Description	Options
Power Management	This function allows you to set the default parameters for power-saving modes. Set it to Disable to turn off the power management function. Set it to User Define to choose your own parameters. See the Power Management Mode Table on page 57.	User Define Max Saving Mix Saving Disabled
PM Control by APM	If "Max Saving" in the Power Management parameter is selected, you can turn on this item, transfer power management control to APM (Advanced Power Management) and enhance the power saving function. For example, you can stop the CPU internal clock.	Yes No

Parameter	Description	Options
Video Off After	Turns off the video monitor after the selected power down option.	Suspend N/A Doze Standby
Video Off Method	This determines the way that the monitor stays off. Blank Screen writes blanks to the video buffer. V/H SYNC+Blank allows BIOS to control VSYNC and HSYNC signals. This function applies only for DPMS (Display Power Management Standard) monitor. The DPMS mode uses the DPMS function provided by the VGA card.	V/H SYNC + Blank DPMS Blank Screen
MODEM Use IRQ	This item lets you set an IRQ for the modem.	3, 4, 5, 7, 9, 10, 11, and N/A
Soft-Off by PWRBTN	This is a specification of ACPI and supported by hardware. When Delay 4 sec. is selected, the soft power switch on the front panel can be used to control power On, Suspend and Off. If the switch is pressed less than 4 sec during power On, the system will go into Suspend mode. If the switch is pressed longer than 4 sec, the system will be turned Off. The other setting is Instant-Off , where the soft power switch is only used to control On and Off, there is no need to press 4 sec, and there is no Suspend.	Delay 4 sec. Instant-Off
HDD Power Down	This option lets you specify the IDE HDD idle time before the device enters the power down state. This item is independent from the power states previously described in this section (Standby and Suspend).	Disabled 1 min. 15 min.

Parameter	Description	Options
Doze Mode	This item lets you set the period of time after which the system enters into Doze mode. The system activity (or event) is detected by monitoring the IRQ signals or other events (such as I/O).	Disabled 1 min. 2 min. 4 min. 8 min. 12 min. 20 min. 30 min. 40 min. 1 Hour
Suspend Mode	This item lets you set the period of time after which the system enters into Suspend mode. The Suspend mode can be Power On Suspend or Suspend to Hard Drive, and it is selected in the "Suspend Mode Option".	Disabled 1 min. 2 min. 4 min. 8 min. 12 min. 20 min. 30 min. 40 min. 1 Hour
VGA PCI/Master	To enable or disable the detection of COM port, LPT, VGA , and PCI activities for power down state transition.	OFF ON
HDD & FDD	To enable or disable the detection of HDD and FDD activities for power down state transition.	ON OFF
LPT & COM	To enable or disable the detection of COM port and LPT activities for power down state transition.	LPT/COM None LPT COM

Parameter	Description	Options
Wake on LAN/ Modem	This option allows you to enable or disable the wake on LAN/modem function. When Enabled, internal modem/LAN card can wake up the system from shutdown or suspend mode.	Enabled Disabled
Primary INTR	This item is used to enable or disable the detection of IRQ3-15 or NMI interrupt events for power down state transition. Normally, this is applied to the network card.	ON OFF
IRQ [3-7,12-14]	Select Primary or Disabled option to enable or disable the detection of each specified IRQ. If the Secondary option was selected, the system will wake up for 2ms after detecting the interrupt, and then return to power down status.	Primary Secondary Disabled
IRQ [8,15]	Select Primary or Disabled option to enable or disable the detection of each specified IRQ. If the Secondary option was selected, the system will wake up for 2ms after detecting the interrupt, and then return to power down status.	Disabled Primary Secondary
IRQ [9-11]	Select Primary or Disabled option to enable or disable the detection of each specified IRQ. If the Secondary option was selected, the system will wake up for 2ms after detecting the interrupt, and then return to power down status.	Secondary Disabled Primary

Power Management Mode Table

Mode	Doze	Standby	Suspend	HDD Power Down
Max Saving	1 hour	1 hour	1 hour	15 min.
Min Saving	1 min.	1 min.	1 min.	1 min.

PnP/PCI Configuration

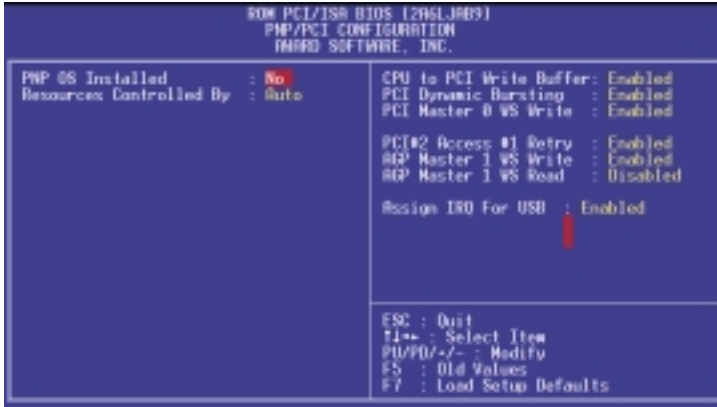

The table below describes the parameters found in this menu. Settings in **boldface** are the default and suggested settings.

Parameter	Description	Options
PnP OS Installed	Normally, the PnP resources are allocated by BIOS during the POST (Power-on self-test). If you are using a PnP operating system (such as Windows 95/98), set this item to Yes to inform BIOS to configure only the resources needed for booting (VGA/IDE or SCSI). The rest of the system resources will be allocated by the PnP operating system.	No Yes
Resources Controlled By	Setting this option to Manual allows you to individually assign the IRQs and DMAs to the ISA and PCI devices. Set this to Auto to enable the auto-configuration function.	Auto Manual

Parameter	Description	Options
IRQ3 (COM2) IRQ4 (COM1) IRQ5 (Network/ Sound or Others) IRQ7 (Printer or Others) IRQ9 (Video or Others) IRQ10 (SCSI or Others) IRQ11 (SCSI or Others) IRQ12 (PS/2 Mouse) IRQ14 (IDE1) IRQ15 (IDE2)	If your ISA card is not PnP compatible and requires a special IRQ to support its function, set the selected IRQ to Legacy ISA . This setting informs the PnP BIOS to reserve the selected IRQ for the installed legacy ISA card. The default is PCI/ISA PnP . Take note that PCI cards are always PnP compatible (except old PCI IDE cards).	PCI/ISA PnP Legacy ISA
DMA 0 DMA 1 DMA 3 DMA 5 DMA 6 DMA 7	If your ISA card is not PnP compatible and requires a special DMA channel to support its function, set the selected DMA channel to Legacy ISA . This setting informs the PnP BIOS to reserve the selected DMA channel for the installed legacy ISA card. The default is PCI/ISA PnP . Take note that the PCI card does not required DMA channel.	PCI/ISA PnP Legacy ISA
CPU to PCI Write Buffer	This item is used to enable or disable the CPU to the PCI write buffer.	Enabled Disabled
PCI Dynamic Bursting	This item is used to enable or disable PCI dynamic bursting.	Enabled Disabled
PCI Master 0 WS Write	This item is used to control the PCI master write cycle. If enabled, there is no wait state. If disabled, there will be one wait state for PCI master write.	Enabled Disabled

Parameter	Description	Options
PCI#2 Access #1 Retry	This item is used to enable or disable AGP master retry disconnect. If enabled, AGP master will be disconnected if max retries are attempted without success. PCI#2 means AGP.	Enabled Disabled
AGP Master 1 WS Write	This item is used to enable or disable AGP master 1 wait state write.	Enabled Disabled
AGP Master 1 WS Read	This item is used to enable or disable AGP master 1 wait state read.	Disabled Enabled
Assign IRQ for USB	This item lets you set an IRQ for the USB.	Enabled Disabled

Load Setup Defaults

The default setup values may not be the best setting for your motherboard, but these values are qualified as reliable settings, especially if you have limited loading of add-on cards and memory size (for example, a system that contains only a VGA/Sound card and two DIMMs).

To attain the best system performance, you may manually set the parameters in the "Chipset Features Setup" to get the proprietary settings. Make sure that you know and understand the functions of every item in the Chipset Setup menu.

Product Information

This screen displays information about your system, like the product name, serial number, mainboard ID, mainboard serial number, BIOS version, etc. These entries are for your reference only and cannot be changed.

Integrated Peripherals



The table below describes the parameters found in this menu. Settings in **boldface** are the default and suggested settings.

Parameter	Description	Options
OnChip Primary IDE	These parameters let you enable or disable the IDE devices connected to the primary and secondary IDE connectors.	Enabled
OnChip Secondary IDE		Disabled
IDE Prefetch Mode	This item is used to enable and disable IDE prefetch mode.	Enabled Disabled
IDE HDD Block Mode	This feature enhances disk performance by allowing multisector data transfers and eliminates the interrupt handling time for each sector. Most IDE drives, except with old designs, can support this feature.	Enabled Disabled

Parameter	Description	Options
Primary Master PIO	Setting these items to Auto activates the HDD speed auto-detect function.	Auto Mode 1
Primary Slave PIO	The PIO mode specifies the data transfer rate of the HDD. For example: mode 0 data transfer rate is 3.3MB/s, mode 1 is 5.2MB/s, mode 2 is 8.3MB/s, mode 3 is 11.1MB/s and mode 4 is 16.6MB/s. If your hard disk performance becomes unstable, you may manually try the slower mode.	Mode 2 Mode 3 Mode 4
Secondary Master PIO		
Secondary Slave PIO		
<p>Caution: <i>It is recommended that you connect the first IDE device of each channel to the endmost connector of the IDE cable.</i></p>		
Primary Master UDMA	These items allow you to set the Ultra DMA/33 mode supported by the hard disk drive connected to your primary and secondary IDE connectors.	Auto Disabled
Primary Slave UDMA		
Secondary Master UDMA		
Secondary Slave UDMA		
Init Display First	If you installed a PCI VGA card and an AGP card at the same time, this item lets you decide which one is the initial display card.	PCI AGP
Onchip Sound	This item is used to enable or disable the onboard audio CODEC.	Enabled Disabled

Parameter	Description	Options
Onchip Legacy Audio	This item is used to enable or disable the onboard legacy audio. If enabled, the following parameters can be selected:	Disabled Enabled
	SB I/O Base	220H , 240H, 260H, and 280H
	SB IRQ Select	IRQ5 , IRQ7, IRQ9, and IRQ10
	SB,DMA Select	DMA1 , DMA0, DMA2, and DMA3
	MPU-401 I/O Address	330-333 , 300-303, 310-313, and 320-323H
Onboard FDD Controller	Setting this parameter to Enabled allows you to connect your floppy disk drives to the onboard floppy disk connector instead of a separate controller card. Change the setting to Disabled if you want to use a separate controller card.	Enabled Disabled
Onboard Serial Port 1	This item allows you to assign an address and interrupt for the board serial port.	3F8/IRQ4 Auto 2F8/IRQ3 3E8/IRQ4 2E8/IRQ3 Disabled
Onboard Serial Port 2	This item allows you to assign an address and interrupt for the board serial port.	2F8/IRQ3 Auto 3F8/IRQ4 3E8/IRQ4 2E8/IRQ3 Disabled

Parameter	Description	Options
Onboard Parallel Port	This item controls the onboard parallel port address and interrupt. <i>Note: If you are using an I/O card with a parallel port, make sure that the addresses and IRQs do not conflict.</i>	378/IRQ7 3BC/IRQ7 278/IRQ7 Disabled
Parallel Port EPP Type	This item lets you select the EPP mode.	EPP1.9 EPP1.7
Onboard Parallel Mode	This item lets you set the parallel port mode. The mode options are Normal (Standard and Bidirection Parallel Port), EPP (Enhanced Parallel Port) and ECP (Extended Capabilities Port). Normal is the IBM AT and PS/2 compatible mode. EPP enhances the parallel port throughput by directly writing/reading data to/from parallel port without latch. ECP supports DMA and RLE (Run Length Encoded) compression and decompression.	EPP Normal SPP ECP ECP/EPP
Onchip USB 1 - 2	This item is used to enable or disable the Onchip USB.	Enabled Disabled
USB Keyboard Support	This item lets you enable or disable the USB keyboard driver within the onboard BIOS. The keyboard driver simulates legacy keyboard command and lets you use a USB keyboard during POST or after boot if you don't have a USB driver in the operating system.	Enabled Disabled

Password Setting

A password prevents unauthorized use of your computer. If you set a password, the system prompts for the correct password before booting or to access Setup.

To set a password:

1. At the prompt, type your password. Your password can be up to 8 alphanumeric characters. When you type the characters, they appear as asterisks on the password screen box.
2. After typing the password, press **Enter**.
3. At the next prompt, retype your password and press **Enter** again to confirm the new password. After the password entry, the screen automatically reverts to the main screen.

To disable the password, press **Enter** when prompted to enter the password. The screen displays a message confirming that the password has been disabled.

IDE HDD Auto Detection

If your system has an IDE hard drive, you can use this function to detect its parameters and enter them into the "Standard CMOS Setup" automatically.

This routine only detects one set of parameters for your IDE hard drive. Some IDE drives can use more than one set of parameters. If your hard disk is formatted using different parameters than those detected, you have to enter the parameters manually. If the parameters listed do not match the ones used to format the disk, the information on that disk will not be accessible. If the auto-detected parameters displayed do not match those that are used for your drive, ignore them. Type **N** to reject the values and enter the correct ones manually from the Standard CMOS Setup screen.

Save & Exit Setup

This function automatically saves all CMOS values before leaving Setup.

Exit without Saving

Use this function to exit Setup without saving the CMOS value changes. Do not use this option if you want to save the new configuration.

**Upgrading the
System**

Chapter 4

This chapter tells you how to remove and replace the system housing, and to install optional components to upgrade the system. It gives brief and clear instructions accompanied by mechanical illustrations showing how to perform each described procedure.

Installation Precautions

Before you install any system component, we recommend that you read the following sections. These sections contain important ESD precautions along with preinstallation and postinstallation instructions.

ESD Precautions

Electrostatic discharge (ESD) can damage your processor, disk drives, expansion boards, and other components. Always observe the following precautions before you install a system component:

1. Do not remove a component from its protective packaging until you are ready to install it.
2. Wear a wrist grounding strap and attach it to a metal part of the system unit before handling components. If a wrist strap is not available, maintain contact with the system unit throughout any procedure requiring ESD protection.

Preinstallation Instructions

Always observe the following before you install a system component:

1. Turn off the system power and all the peripherals connected to the unit before opening it.
2. Open the system according to the instructions on page 75.
3. Follow the ESD precautions described above before handling a system component.
4. Remove any expansion boards or peripherals that block access to the DIMM sockets or CPU connector.
5. See the following sections for specific instructions on the component you wish to install.



Warning! *Not turning off the system properly before you start installing the components may damage your system.*

Do not attempt the procedures described in the following sections unless you are a qualified service technician.

Postinstallation Instructions

Observe the following after installing a system component:

1. See to it that the components are installed according to the step-by-step instructions in their respective sections.
2. Make sure you have set all the required jumpers. See “Jumpers and Connectors” on page 27 for the correct jumper settings.
3. Replace any expansion boards or peripherals that you removed earlier.
4. Replace the system cover.
5. Connect the necessary cables and turn on the system.

Opening the System



Caution: Before you proceed, make sure that you have turned off the system and all peripherals connected to it. Read the “Preinstallation Instructions” on page 73.

This section tells you how to open the housing cover when you need to install additional components inside the system unit.

Removing the Housing Cover

1. Turn off the system power and unplug all cables.
2. Place the system unit on a flat, steady surface.
3. Remove the screws (two) on one side of the cover using a screwdriver. Set the screws aside.
4. Hold the side of the cover with both hands. Slide it back about an inch and then gently pull it outward to detach it.



5. Follow steps 3 and 4 to remove the other side.

Replacing the Housing Cover

1. Align the cover's hinges to the housing frame and then gently push it in. Slide it back into place.

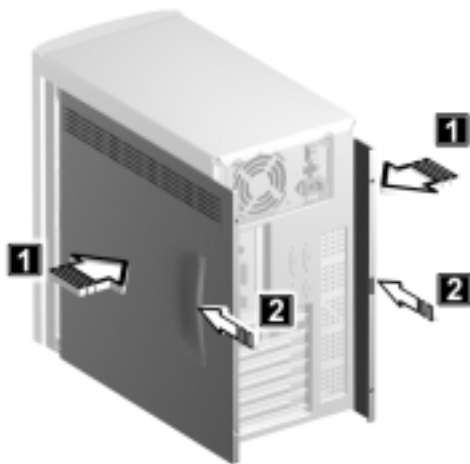

2. Secure the cover with two screws.
3. Follow steps 1 and 2 to replace the other side.

Installing Additional Memory

The three 168-pin sockets onboard support SDRAM-type DIMMs. You may install 32-MB, 64-MB, or 128-MB (single and double density) DIMMs for a maximum of 384-MB system memory.

The SDRAM DIMMs should work under 3.3 volts only; 5-volt memory devices are not supported. This system board supports both PC-100 (100MHz) and PC-133 (133 MHz) SDRAM. However, they cannot be used at the same time in a system. Please contact your dealer for qualified DIMM vendors.



Do not use both PC-100 (100 MHz) and PC-133 (133 MHz) SDRAM together. Such a combination might cause your system to malfunction.

Each of the DIMM sockets is independent from the others. This independence allows you to install DIMMs with different capacities to form different configurations.

Installing a DIMM

1. Open the clips on the socket.
2. Align the DIMM with the socket.
3. Press the DIMM into the socket until the clips lock onto the DIMM.

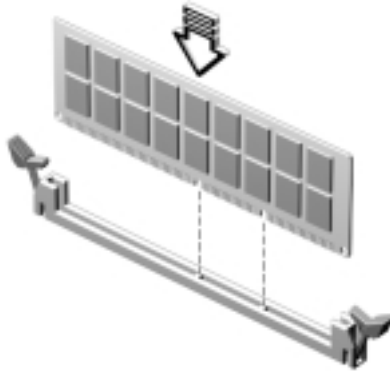

Note: The DIMM socket is slotted to ensure proper installation. If you insert a DIMM but it does not fit easily into the socket, you may have inserted it incorrectly. Turn the DIMM around and try to insert it again.

Removing a DIMM

1. Press the holding clips on both sides of the socket outward to release the DIMM.
2. Gently pull the DIMM out of the socket.

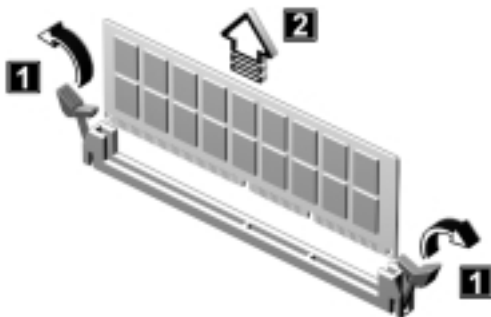

Reconfiguring the System

The system automatically detects the amount of memory installed. Run Setup to view the new value for total system memory and make a note of it.

Upgrading the CPU

Removing the CPU



Note: Observe the ESD precautions on page 73 when installing or removing a system component.

Before you can replace or upgrade your processor, you need to remove the previously installed processor on the system board.

Follow these steps to remove the CPU:

1. On the system board, locate the CPU mounted on the socket.
2. Detach the fan/heatsink cable connectors.

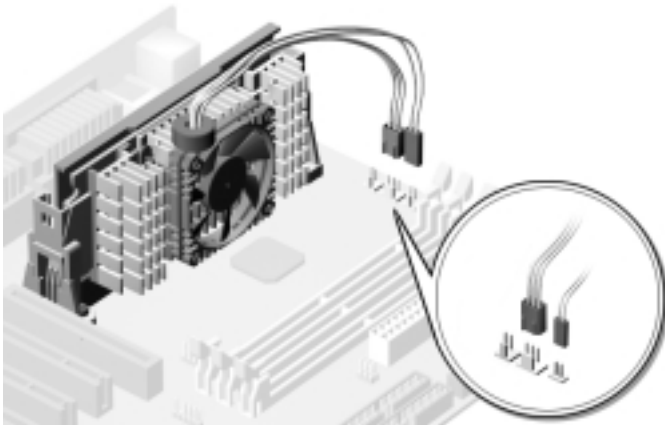

3. Gently pull the CPU straight up from its socket.

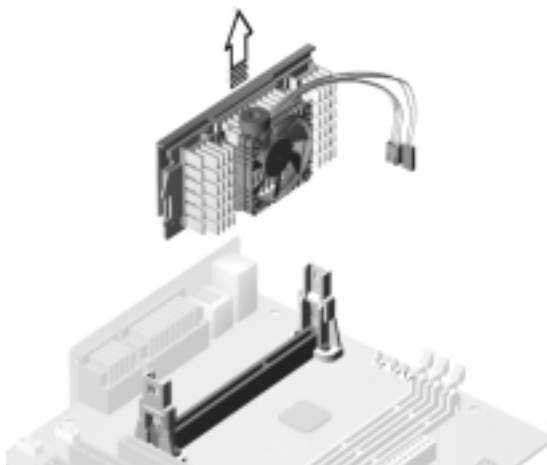

Installing the CPU



Note: Observe the ESD precautions on page 73 when installing or removing a system component.

Follow these steps to upgrade the CPU:

1. Insert the CPU as shown in the figure below.

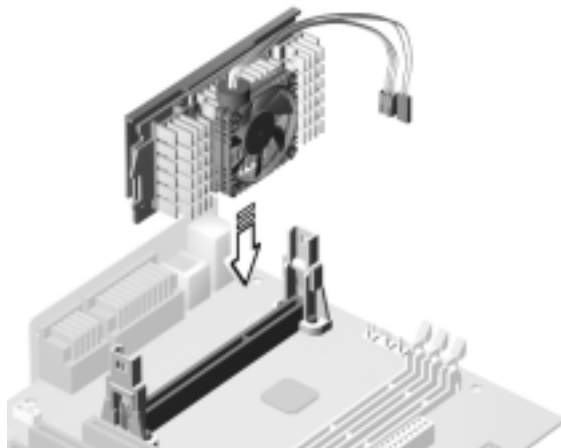

2. Plug the fan/heatsink cable into the fan and thermal connectors. See “Jumpers and Connectors” on page 27 for the location of the connectors on the system board.

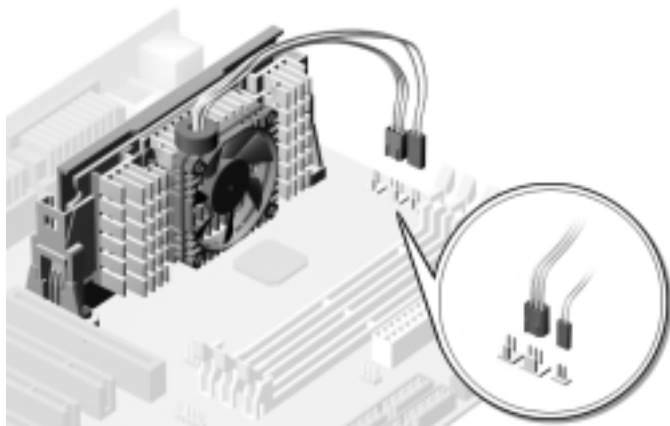

Warning! The heatsink becomes very hot when the system is on. Never touch the heatsink with any metal or with your hands.

Replacing the Hard Disk

Follow these steps to replace the hard disk drive:

1. Remove the cover as shown on page 75.
2. Detach the power cable and the disk drive cable from the hard disk.

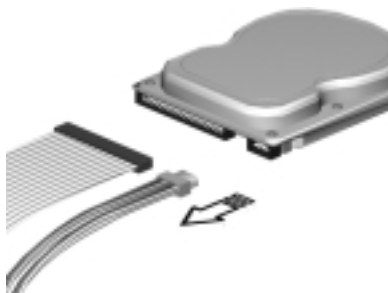

3. Remove four screws that holds the hard disk to the metal bracket frame.



4. Pull out the hard disk drive.



5. Install a new 3.5-inch hard disk drive and connect the disk drive cable and power cable

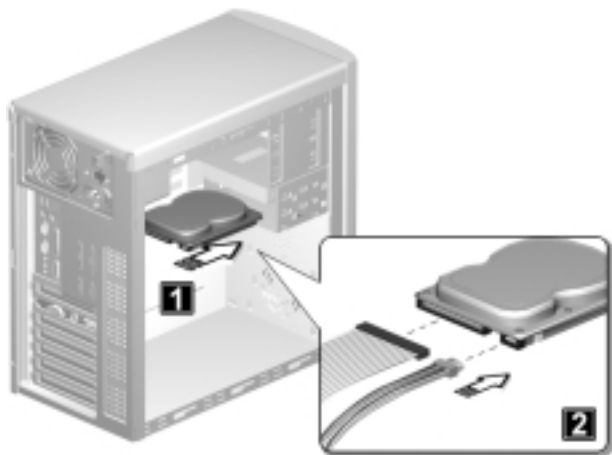

6. Secure the hard disk with the four screws that you have previously removed.



7. Reinstall the housing cover as shown on page 76.



.....
Make sure that the other ends of the diskette drive cables are securely connected to their corresponding connectors on the system board.

Installing PCI and AGP Expansion Cards

To install a PCI or AGP Card:

1. Locate an empty PCI or AGP slot on the system board.
2. Remove the bracket on the housing opposite the selected empty PCI or AGP slot.



3. Remove the PCI or AGP card from its protective packaging.

4. Align the card with the empty bracket and then insert it into the slot. Make sure that the card is properly seated.



5. Secure the card to the housing with a screw.
6. Reinstall the housing cover (see page 76).

When you turn on the system, BIOS automatically detects and assigns resources to the PCI or AGP devices.