

AcerPower 4300

User's Guide

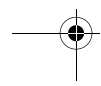

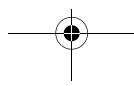
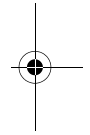
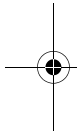

Copyright 1999 Acer Incorporated
All Rights Reserved. Printed in Taiwan

AcerPower 4300 User's Guide
Part No.: 49.30F02.001
Draft Version: May1, 1999

Changes may be made periodically to the information in this publication without obligation to notify any person of such revision or changes. Such changes will be incorporated in new editions of this manual or supplementary documents and publications. This company makes no representations or warranties, either expressed or implied, with respect to the contents hereof and specifically disclaims the implied warranties of merchantability or fitness for a particular purpose.

Record the model number, serial number, purchase date, and place of purchase information in the space provided below. The serial number and model number are recorded on the label affixed to your computer. All correspondence concerning your unit should include the serial number, model number, and purchase information.

No part of this publication may be reproduced, stored in a retrieval system, or transmitted, in any form or by any means, electronic, mechanical, photocopy, recording, or otherwise, without the prior written permission of Acer Incorporated.

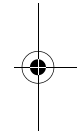
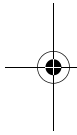

AcerPower 4300 User's Guide

Model Number : _____

Serial Number : _____

Purchase Date : _____

Place of Purchase : _____

All trademarks, registered trademarks and/or service marks are the properties of their respective owners.

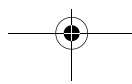

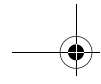

Table of Contents

Notices v

Chapter 1 Getting Started 1

- Overview 3
- Preinstallation 4
 - Selecting a Site 4
 - Unpacking Components 4
- Features 5
 - Front Panel 5
 - Rear Panel 6
 - Internal Components 8
- Connecting System Components 9
 - Connecting the Keyboard 9
 - Connecting the Monitor 10
 - Connecting the Mouse 10
 - Connecting the Printer (optional) 11
 - Connecting Multimedia Components 11
 - Connecting to the Network (optional) 12
 - Connecting the Fax/Modem (optional) 12
 - Connecting USB Devices (optional) 13
- Turning On Your Computer 14
- Turning Off Your Computer 15
- Troubleshooting 16
- Error Messages 18
 - Software Error Messages 18
 - System Error Messages 18
 - Correcting Error Conditions 20

Chapter 2 System Board Information. 23

- Features 25
- Board Layout 27
- Jumpers and Connectors 30
- Floppy Disk/Hard Disk Support 33
- Video Function 34
- Audio Function 35
- USB Support 36
- Hardware Monitoring Function 37
- Modem Ring-in Function 38
- Wake-on LAN 39



Chapter 3 BIOS Information	41
Entering Setup	44
System Information	46
Product Information	49
Disk Drives	51
Onboard Peripherals	55
Onboard Device Settings	57
Power Management	59
Boot Options	61
Date and Time	64
System Security	65
Setting a Password	67
Changing or Removing the Password	68
Bypassing the Password	69
Advanced Options	70
Memory/Cache Options	71
PnP/PCI Options	73
Load Default Settings	75
Abort Settings Change	76
Exiting Setup	77
Chapter 4 Upgrading the System	79
Installation Precautions	81
ESD Precautions	81
Preinstallation Instructions	81
Post-installation Instructions	82
Opening the System	83
Removing the Housing Cover	83
Replacing the Housing Cover	85
Installing Additional Memory	86
Installing a DIMM	88
Removing a DIMM	89
Reconfiguring the System	89
Upgrading the CPU	90
Removing the CPU	90
Installing the Upgrade CPU	92
Replacing the Hard Disk	94
Installing and Removing a PCI Card	96
Installing a PCI Card	96
Removing a PCI Card	97

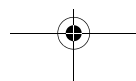
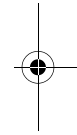
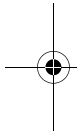



Notices

FCC Notice

This device has been tested and found to comply with the limits for a Class B digital device pursuant to Part 15 of the FCC Rules. These limits are designed to provide reasonable protection against harmful interference in a residential installation. This device generates, uses, and can radiate radio frequency energy and, if not installed and used in accordance with the instructions, may cause harmful interference to radio communications.

However, there is no guarantee that interference will not occur in a particular installation. If this device does cause harmful interference to radio or television reception, which can be determined by turning the device off and on, the user is encouraged to try to correct the interference by one or more of the following measures:

- Reorient or relocate the receiving antenna
- Increase the separation between the device and receiver
- Connect the device into an outlet on a circuit different from that to which the receiver is connected
- Consult the dealer or an experienced radio/television technician for help

Notice: Shield Cables

All connections to other computing devices must be made using shielded cables to maintain compliance with FCC regulations.

Notice: Peripheral Devices

Only peripherals (input/output devices, terminals, printers, etc.) certified to comply with the Class B limits may be attached to this equipment. Operation with non certified peripherals is likely to result in interference to radio and TV reception.

Caution

Changes or modifications not expressly approved by the manufacturer could void the user's authority, which is granted by the Federal Communications Commission, to operate this computer.

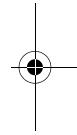
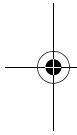



Use Conditions

This part complies with Part 15 of the FCC Rules. Operation is subject to the following two conditions: (1) this device may not cause harmful interference, and (2) this device must accept any interference received, including interference that may cause undesired operation.

Notice: Canadian Users

This Class B digital apparatus meets all requirements of the Canadian Interference-Causing Equipment Regulations.

Remarque à l'intention des utilisateurs canadiens

Cet appareil numérique de la classe B respecte toutes les exigences du Règlement sur le matériel brouilleur du Canada.

Important Safety Instructions

Read these instructions carefully. Save these instructions for future reference.

1. Follow all warnings and instructions marked on the product.
2. Unplug this product from the wall outlet before cleaning. Do not use liquid cleaners or aerosol cleaners. Use a damp cloth for cleaning.
3. Do not use this product near water.
4. Do not place this product on an unstable cart, stand, or table. The product may fall, causing serious damage to the product.
5. Slots and openings in the cabinet and the back or bottom are provided for ventilation; to ensure reliable operation of the product and to protect it from overheating, these openings must not be blocked or covered. The openings should never be blocked by placing the product on a bed, sofa, rug, or other similar surface. This product should never be placed near or over a radiator or heat register, or in a built-in installation unless proper ventilation is provided.
6. This product should be operated from the type of power indicated on the marking label. If you are not sure of the type of power available, consult your dealer or local power company.
7. Do not allow anything to rest on the power cord. Do not locate this product where persons will walk on the cord.
8. If an extension cord is used with this product, make sure that the total ampere rating of the equipment plugged into the extension

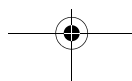
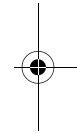
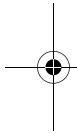



cord does not exceed the extension cord ampere rating. Also, make sure that the total rating of all products plugged into the wall outlet does not exceed the fuse rating.

9. Never push objects of any kind into this product through cabinet slots as they may touch dangerous voltage points or short out parts that could result in a fire or electric shock. Never spill liquid of any kind on the product.
10. Do not attempt to service this product yourself, as opening or removing covers may expose you to dangerous voltage points or other risks. Refer all servicing to qualified service personnel.
11. Unplug this product from the wall outlet and refer servicing to qualified service personnel under the following conditions:
 - a. When the power cord or plug is damaged or frayed
 - b. If liquid has been spilled into the product
 - c. If the product has been exposed to rain or water
 - d. If the product does not operate normally when the operating instructions are followed. Adjust only those controls that are covered by the operating instructions since improper adjustment of other controls may result in damage and will often require extensive work by a qualified technician to restore the product to normal condition.
 - e. If the product has been dropped or the cabinet has been damaged
 - f. If the product exhibits a distinct change in performance, indicating a need for service.
12. Replace the battery with the same type as the product's battery we recommend. Use of another battery may present a risk of fire or explosion. Refer battery replacement to a qualified serviceman.
13. **Warning!** Batteries may explode if not handled properly. Do not disassemble or dispose of them in fire. Keep them away from children and dispose of used batteries promptly.
14. Use only the proper type of power supply cord set (provided in your accessories box) for this unit. It should be a detachable type: UL listed/CSA certified, type SPT-2, rated 7A 125V minimum, VDE approved or its equivalent. Maximum length is 15 feet (4.6 meters).

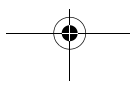
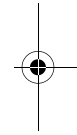
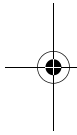



Year 2000 Compliance Statement

This product is Year 2000-compliant and carries the “NSTL Hardware Tested Year 2000 Compliant” logo. This product has been tested both by Acer’s internal test labs and NSTL using NSTL’s YMARK2000 certification test. These tests certify that this product will successfully make the year 2000 transition.



For more details, check the Acer Year 2000 Resource Center at <http://www.acer.com.tw/service/y2k/>

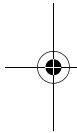

Laser Compliance Statement

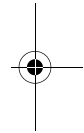

The CD-ROM drive in this computer is a laser product. The CD-ROM drive’s classification label (shown below) is located on the drive.

CLASS 1 LASER PRODUCT

CAUTION: INVISIBLE LASER RADIATION WHEN OPEN.
AVOID EXPOSURE TO BEAM.

APPAREIL A LASER DE CLASSE 1 PRODUIT

LASERATTENTION: RADIATION DU FAISCEAU LASER
INVISIBLE EN CAS D’OUVERTURE. EVITER TOUTE
EXPOSITION AUX RAYONS.

LUOKAN 1 LASERLAITE LASER KLASSE 1

VORSICHT: UNSICHTBARE LASERSTRAHLUNG, WENN
ABDECKUNG GEÖFFNET NICHT DEM STRAHL AUSSETZEN

PRODUCTO LÁSER DE LA CLASE I

ADVERTENCIA: RADIACIÓN LÁSER INVISIBLE AL SER
ABIERTO. EVITE EXPONERSE A LOS RAYOS.

ADVARSEL: LASERSTRÅLING VEDÅBNING SE IKKE IND I
STRÅLEN.

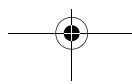

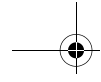

VARO! LAVATTAESSA OLET ALTTINA LASERSÄTEILYLLE.
WARNING: LASERSTRÄLNING NÄR DENNA DEL ÄR ÖPPNAD
ÄLÄ TUJJOITA SÄTEESEENSTIRRA EJ IN I STRÄLEN
WARNING: LASERSTRÄLNING NÄR DENNA DEL ÄR
ÖPPNADSTIRRA EJ IN I STRÄLEN
ADVARSEL: LASERSTRÄLNING NÄR DEKSEL ÄPNESSTIRR IKKE
INN I STRÄLEN

Lithium Battery Statement

CAUTION

Danger of explosion if battery is incorrectly replaced. Replace only with the same or equivalent type recommended by the manufacturer. Discard used batteries according to the manufacturer's instructions.

ADVARSEL!

Lithiumbatteri - Eksplosjonsfare ved feilagtig håndtering. Udskitning må kun ske med batteri af samme fabrikat og type. Léver det brugte batteri tilbage til leverandøren.

ADVARSEL

Ekspløsjonsfare ved feilaktig skifte av batteri. Benytt samme batteritype eller en tilsvarende type anbefalt av apparatfabrikanten. Brukte batterier kasseres i henhold til fabrikantens instruksjoner.

WARNING

Explosionsfara vid felaktigt batteribyte. Använd samma batterityp eller en ekvivalent typ som rekommenderas av apparattillverkaren. Kassera använt batteri enligt fabrikantens instruktion.

VAROITUS

Päristo voi räjähtää, jos se on virheellisesti asennettu. Vaihda paristo ainoastaan laitevalmistajan suosittelemaan tyyppiin. Hävitä käytetty paristo valmistajan ohjeiden mukaisesti.

VORSICHT!

Explosionsgefahr bei unsachgemäßen Austausch der Batterie Ersatz nur durch denselben oder einem vom Hersteller empfohlenem ähnlichen Typ. Entsorgung gebrauchter Batterien nach Angaben des Herstellers.

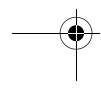
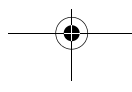
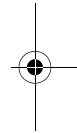
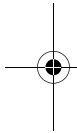

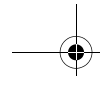

x Notices

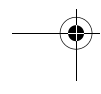
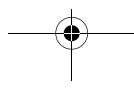
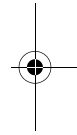
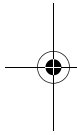

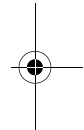
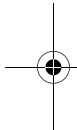
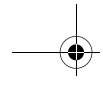

Getting Started

Chapter 1

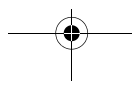

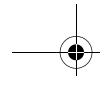

This chapter gives you a general introduction of the system unit and tells you how to select a site and set up the system. It also includes a simple troubleshooting section to allow you to check your system before you ask for technical support.

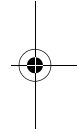
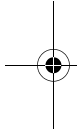

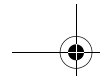

Overview

The AcerPower 4300 is an all-in-one, high-performance system that supports the Intel Celeron (with integrated second-level cache). It utilizes the PCI (Peripheral Component Interface) and the AGP (Accelerated Graphics Port) bus designs. Both designs improve system performance, enabling the system to support various multimedia functions and applications.

Aside from the standard I/O (Input/Output) interfaces such as two serial ports, one parallel port, and PS/2 keyboard and mouse ports, the system also comes with two USB (Universal Serial Bus) ports, one mono Microphone-in port, one stereo Line-in port, one Line-out port, and one Game/MIDI (Musical Instrument Digital Interface) port. These additional ports are included to enable the system to accommodate additional peripherals.

The system may also come with an onboard AGP video controller, an onboard audio controller, an external fax/modem card and/or a network card. These additional features offer special functions that will enable you to take full advantage of the system. Special features such as hardware monitoring, wake-on LAN, modem ring-in, USB, power management, video and audio functions are discussed in Chapter 2 of this manual.

Furthermore, this system is fully compatible with MS-DOS v6.X, OS/2, SCO UNIX, Windows 98 and Windows NT operating systems.

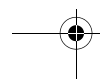
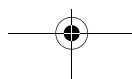
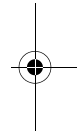
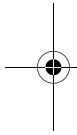



4 Chapter 1 Getting Started



Preinstallation

The preinstallation process involves the following activities:

- Selecting a site
- Unpacking components

Selecting a Site

Consider the following when selecting a site for your computer:

- Determine the best site for your system. Cable paths should not run near equipment that might cause electromagnetic or radio frequency interference such as radio transmitters, televisions, copy machines, or heating and air-conditioning equipment.
- Route cables away from personnel and equipment traffic.
- Avoid dusty areas and extremes of temperature and humidity.

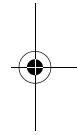
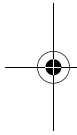

Unpacking Components

Unpack the contents of each box carefully. Save all packing materials in case you need to move or ship the system in the future.

Check that all items are present and in good condition. Contact your dealer immediately if anything is missing or damaged.



Features

The basic configuration consists of a system unit, a keyboard, a CD-ROM drive, a diskette drive, a fixed disk drive and a mouse.

Front Panel

The figure below shows the system unit front panel.

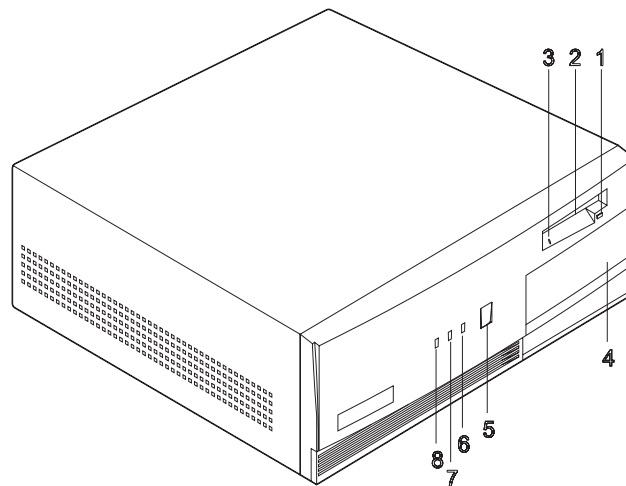

No.	Component
1	Floppy disk drive eject button
2	Floppy disk drive
3	Floppy disk active indicator
4	Drive bay cover for additional 5.25-inch storage Device
5	Power button



6 Chapter 1
Getting Started



No.	Component
6	Power/Suspend indicator
7	Network active/Turbo indicator
8	Hard disk/Message indicator

Rear Panel

The figure below shows the system unit rear panel.

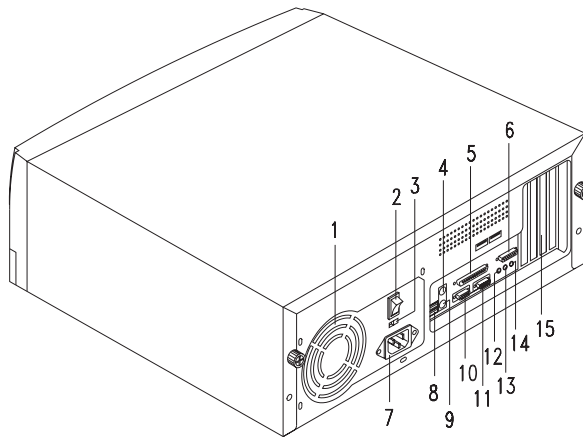

No.	Component
1	Fan
2	System main power switch
3	Voltage selector
4	PS/2 mouse port

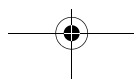
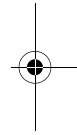
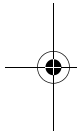

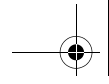

No.	Component
5	Parallel port
6	Game/MIDI port
7	System power socket
8	USB ports
9	PS/2 keyboard port
10	Serial port 2
11	VGA/Monitor port
12	Speaker-out/Line-out port
13	Line-in port
14	Microphone-in port
15	Add-on card brackets

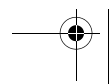
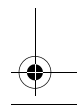
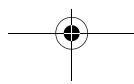
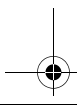
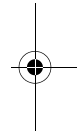
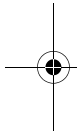

Internal Components

The figure below shows the system unit internal components.

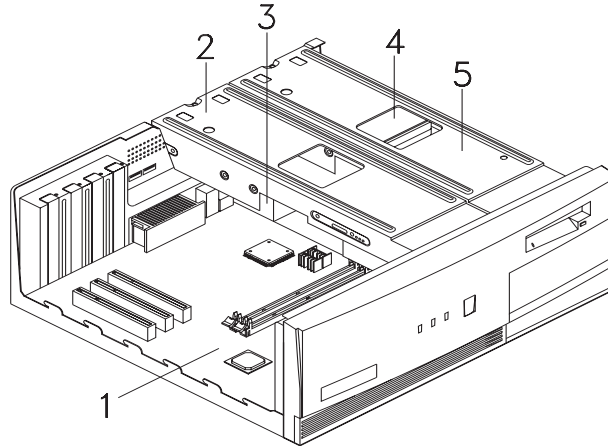

No.	Component
1	System Board
2	Metal bracket frame for hard disk installation
3	Power supply
4	Hard disk drive
5	Metal bracket frame for floppy disk drive



Connecting System Components



Caution: Do not turn on the system main power switch on the rear panel of the system or plug the system in until you finish connecting all system components.

The following sections show how to connect each component to the system:

Connecting the Keyboard

Plug the keyboard cable into the keyboard socket on the rear panel.

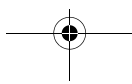
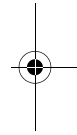
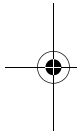
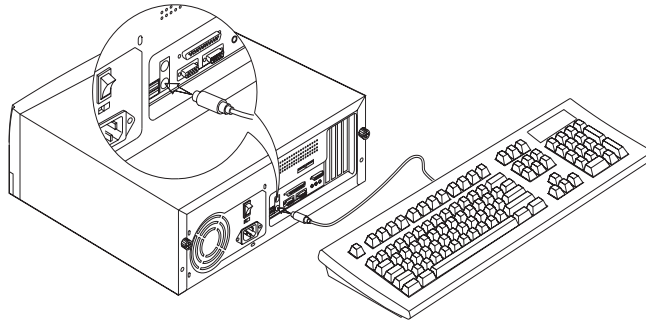



10 Chapter 1
Getting Started



Connecting the Monitor

Plug the monitor signal cable into the VGA connector on the rear panel.

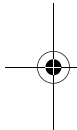
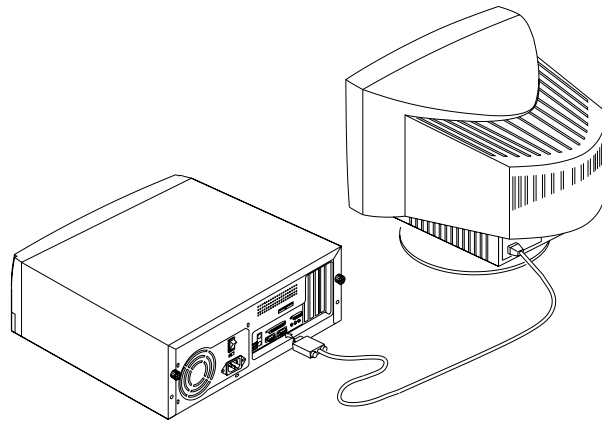

Connecting the Mouse

Plug the mouse cable into the mouse connector on the rear panel.

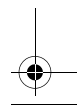
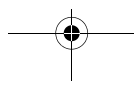
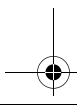
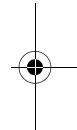
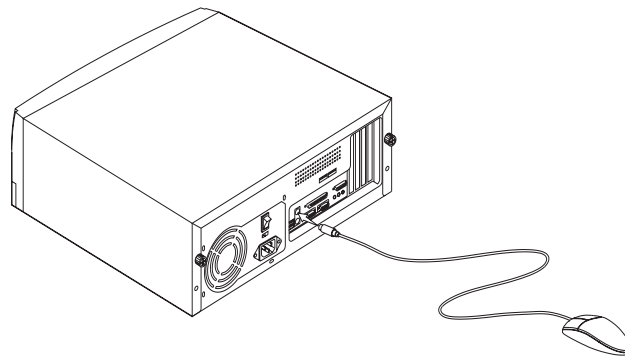



Connecting the Printer (optional)

Check your printer before you connect it to your system. If you have a parallel printer, connect it to the parallel port on the rear panel.

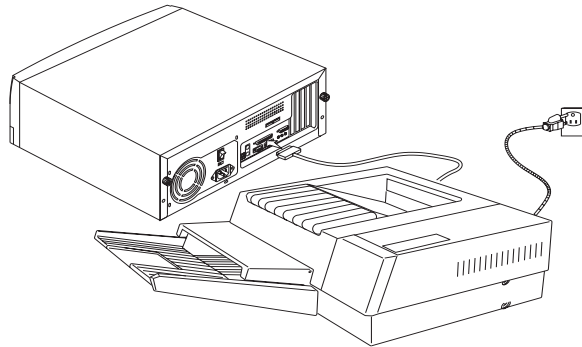

If you have a serial printer or other serial peripheral, connect it to the serial port (COM2). See “Rear Panel” on page 6 for the location of the serial ports.

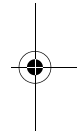
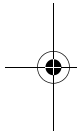

Connecting Multimedia Components

Your system also supports optional multimedia features. Connect the multimedia components as shown below:

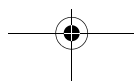
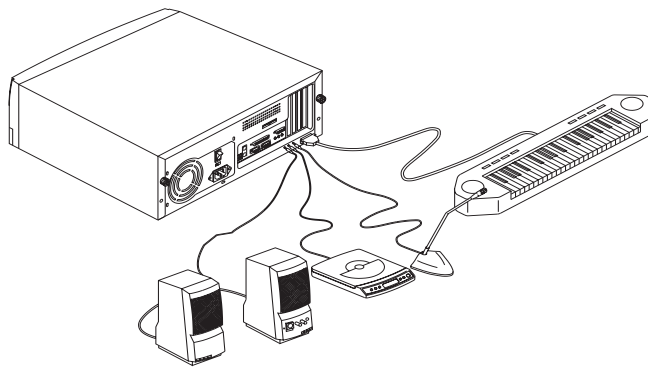

Connecting to the Network (optional)

Your system may come with a LAN (Local Area Network) card for network connection. To connect your system to the network, plug the network cable into the card's network port.

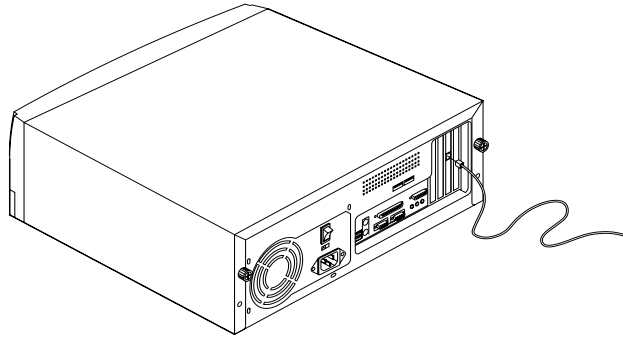

Connecting the Fax/Modem (optional)

Your system may also come with a fax/modem. To activate it, connect the telephone line and handset to the fax/modem ports as shown below:

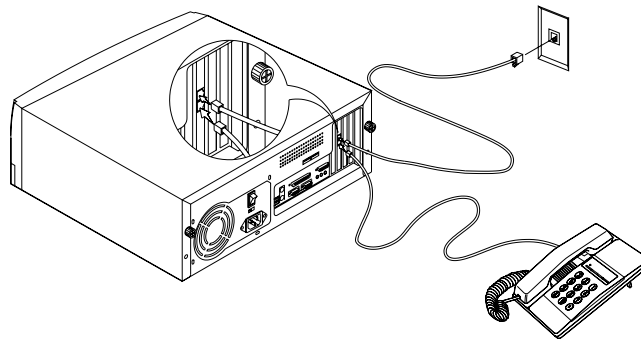



Connecting USB Devices (optional)

The USB ports on the rear panel enable the system to support additional serial devices without using up your system resources.

To connect a USB device, simply plug the device cable into a USB port on the rear panel.

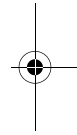
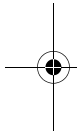
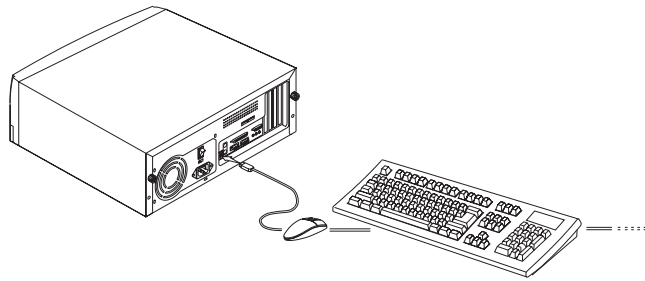

Note: Most USB devices have a built-in USB port which allows you to daisy-chain other devices.

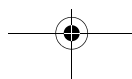

Turning On Your Computer

After you have connected all peripherals and cables, follow these steps to turn on your computer:

1. Turn on all peripherals connected to the system such as the monitor, printer, fax, speakers, etc.
2. Locate the system main power switch on the back of the system and turn it on.

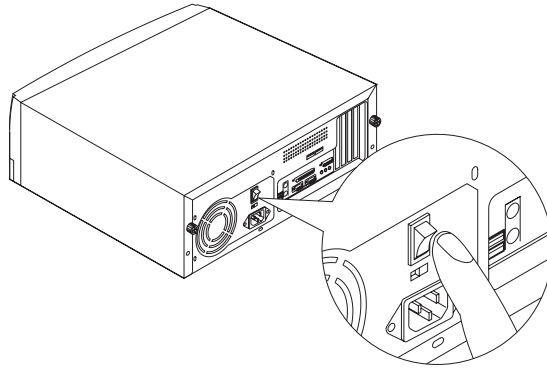

3. Press the power button located on the front of the system unit.

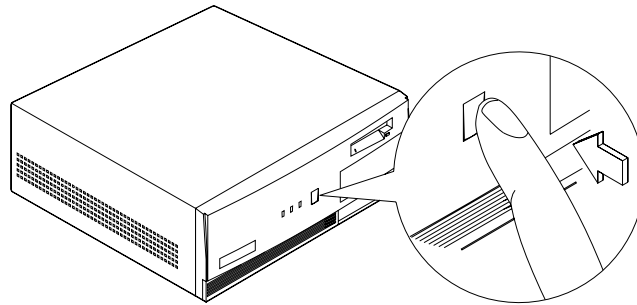

When the system finishes booting, the computer is now ready for use.

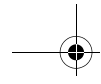

Turning Off Your Computer

1. Turn off all peripherals connected to the system such as the monitor, printer, fax, speakers, etc.
2. Press the power button located on the front of the system unit for at least four seconds. Quickly pressing the button puts the system in Suspend mode only.



Note: You do not need to turn off the system main power switch on the rear panel every time you turn off your computer.

Turn off the system main power switch only:

- if you will not use your system for a long period of time.
- if you need to open your system for any purpose, such as troubleshooting or upgrading.

If the system main power switch is not available, you must unplug the system.

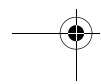
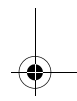
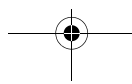
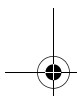
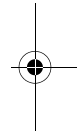
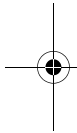



Troubleshooting

If you encounter a hardware problem, we recommend you to review the following suggestions before calling for service:

General failure

- Are all cables securely plugged?
- Are all system components and peripherals turned on?
- Is the system main power switch on?
- Is the power outlet burned out? You may check this by plugging in and turning on some other piece of equipment.
- Are any cables damaged? Are they properly routed and coiled? Entwined cables may cause signal interference.

Front panel light doesn't work

- After turning off the computer, check inside the system unit and make sure that the front panel LED connector for the LED that is not working is correctly plugged. Refer to "Jumpers and Connectors" on page 30 to identify the proper LED connector.

"Garbage" or nothing appears on the screen

- Is the monitor turned on? Is the screen brightness adjusted properly?



.....
Warning! Never open the monitor case. The CRT monitor retains very high voltage levels even after the power is turned off. Refer all monitor service to qualified service technicians.

Keyboard is dead

- Is the keyboard cable plugged in? Turn off the system and plug in the keyboard.



.....
Caution: Do not plug or unplug the keyboard while the power is on.

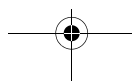
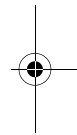
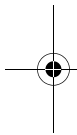



Printer doesn't work

- Is the printer power turned off?
- Is the printer cable connected to the correct port (serial or parallel)?
- Are your application and the printer configured for the same operating values? Be sure there is no conflict with any port on the add-on card. For details, check the documentation that came with your printer.
- Is the printer out of paper or jammed? Check the printer's status indicator lights.
- Are the printer cables tangled? To prevent signal interference, neatly fold or coil excess cable length.

Add-on card fails intermittently

- Do two add-on cards have conflicting addresses? "PnP/PCI Options" on page 73 shows where you can see the addresses in the Setup Utility's Advanced Options. See "Entering Setup" on page 44 for instructions on entering the Advanced Level of the BIOS Utility.

If you receive an error message

- Read the corrective actions listed in "Error Messages" on page 18.

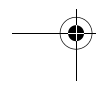
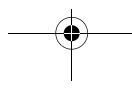
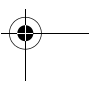
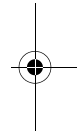
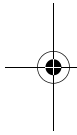



Error Messages

In the event that you receive an error message, do not continue using the computer. Note the message and take corrective action immediately. This section describes the different types of error messages and suggests corrective measures.

There are two general types of error messages:

- Software
- System

Software Error Messages

Software error messages are returned by your operating system or application. These messages typically appear after you boot the operating system or when you run your applications. If you receive this type of message, consult your application or operating system manual for help.

System Error Messages

A system error message indicates a problem with the computer itself. These messages normally appear during the power-on self-test, before the operating system prompt appears.

The table below lists the system error messages.

Error Message	Corrective Action
Memory Error at MMMM:SSSS:0000h (R:xxxxh, W:xxxxh)	Replace the DIMMs. See "Installing a DIMM" on page 88
System Management Memory Bad	Replace the DIMMs. See "Installing a DIMM" on page 88
Keyboard Interface Error	Contact your dealer or an authorized service center.
Keyboard Error or Keyboard Not Connected	Reconnect or replace the keyboard.

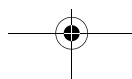
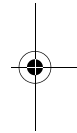
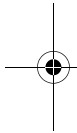



Error Message	Corrective Action
Pointing Device Error	Reconnect or replace the pointing device.
Pointing Device Interface Error	Contact your dealer or an authorized service center.
Pointing Device IRQ Conflict	Contact your dealer or an authorized service center.
IDE Drive 0 Error IDE Drive 1 Error IDE Drive 2 Error IDE Drive 3 Error	Check the HDD cable connections and IDE settings in Setup. See "Disk Drives" on page 51. Replace the disk drive or the HDD (hard disk drive) controller.
IDE Drive 0 / 1 / 2 / 3 Auto Detection Failed	Check the HDD cable connections and IDE settings in Setup. See "Disk Drives" on page 51. Replace the disk drive or the HDD (hard disk drive) controller.
Floppy Drive A Error Floppy Drive B Error	If there is a floppy disk in the drive, remove it. If there is no floppy disk in the drive, turn off the system and check the cable connections. If the connections are okay and the error message continues to show, replace the floppy drive.
Floppy Disk Controller Error	Check the floppy drive cable and its connections. If the cable is good and properly connected, the floppy disk controller may be the problem. Change the floppy disk controller or disable the onboard controller by installing another add-on card with a controller.
CPU Clock Mismatch	When the user changes the CPU frequency, this message will be shown once. Then the BIOS will adjust the CPU clock automatically.

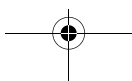
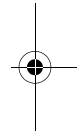
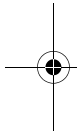



Error Message	Corrective Action
Serial Port Conflict	Change the onboard serial port address in Setup or change the add-on card serial port address. See "Onboard Peripherals" on page 55.
Parallel Port Conflict	Change the onboard parallel port address in Setup or the parallel port address of the add-on card. See "Onboard Peripherals" on page 55.
Real-time Clock error	Contact your dealer or an authorized service center.
CMOS Battery Bad	Contact your dealer or an authorized service center.
CMOS Checksum Error	Contact your dealer or an authorized service center.
Onboard XXX... Conflicts	Try to reassign or disable onboard device resources. See "Onboard Peripherals" on page 55
PCI Device Error	Contact your dealer or an authorized service center.
System Resource Conflict	Contact your dealer or an authorized service center.
IRQ Setting Error	Contact your dealer or an authorized service center.
Expansion ROM Address Allocation Fail	Contact your dealer or an authorized service center.

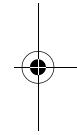
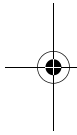

Correcting Error Conditions

As a general rule, the "Press F1 to continue" error message is caused by a configuration problem which can be easily corrected. An equipment malfunction is more likely to cause a fatal error, i.e., an error that causes complete system failure.

Here are some corrective measures for error conditions:

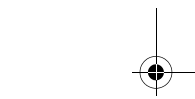
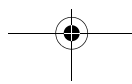



1. Run Setup. You must know the correct configuration values for your system before you enter Setup, which is why you should write these values down when the system is correctly configured. An incorrect Setup configuration is a major cause of power-on error messages, especially for a new system.
2. Remove the system cover according to the directions in the system housing installation guide. Check that the system board and any expansion boards are set correctly.
3. Check that all connectors and boards are secure. Consult the system housing installation guide for assistance.

If you have purchased a new hard disk drive and your computer cannot detect it or access it after installing it, it may be because your disk is not physically formatted. Physically format the disk using the FDISK and FORMAT commands.



Caution: These commands are performed in DOS environment. We recommend that you familiarize yourself with the DOS commands first before you format your hard disk.

If you follow the corrective steps above and still receive an error message, the cause may be an equipment malfunction.

If you are sure that your configuration values are correct and your battery is in good condition, the problem may lie in a damaged or defective chip. Contact an authorized service center for assistance.



Note: If you do not know how to contact an authorized service center, call your distributor.

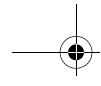

22 Chapter 1
Getting Started

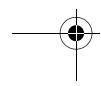
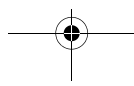
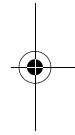
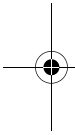

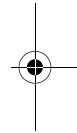
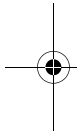
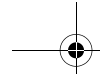

System Board Information

Chapter 2

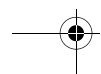
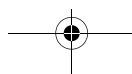

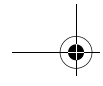

This system board is uniquely-designed to support not only the common features found in today's high-performance system boards, but the multimedia functions as well.

This chapter gives a detailed discussion of the board's components and features.

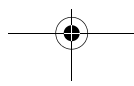
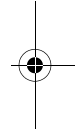
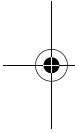



Features

This high-performance system board comes with the following components and features:

Components

- Intel Celeron processor with 128-KB second-level cache running at up to 466 MHz
- Two double in-line memory module (DIMM) sockets that accept 8-, 16-, 32-, 64-, and 128-MB Synchronous Dynamic Random Access Memory (SDRAM) modules, allowing memory upgrade of up to 256 MB
- Peripheral Component Interface (PCI) bus Integrated Device Electronics (IDE) controller
- 3-D Super AGP video accelerator with 8-MB shared-frame buffer, embedded in the North Bridge controller
- Audio controller
- One Wake-on LAN (WOL) connector
- One Modem ring-in connector
- Two PCI enhanced IDE interfaces that support up to four IDE devices
- External ports
 - PS/2 keyboard and mouse ports
 - One buffered high-speed serial port
 - One parallel port that supports Standard Parallel Port (SPP)/Extended Capabilities Port (ECP)/Enhanced Parallel Port (EPP) modes
 - Two Universal Serial Bus (USB) ports
- Three PCI slots

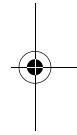
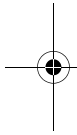

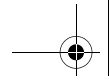

26 Chapter 2 System Board Information



Features

- Plug-and-Play
- Desktop Management Interface (DMI) support
- Advanced Configuration and Power Interface (ACPI)-compliant BIOS
- Software Shutdown support for Windows 98
- Power Management
- USB support
- Hardware Monitoring

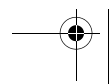
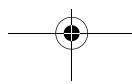
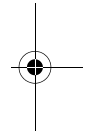
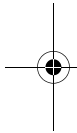



Board Layout

Your system board should look just like the following figure:

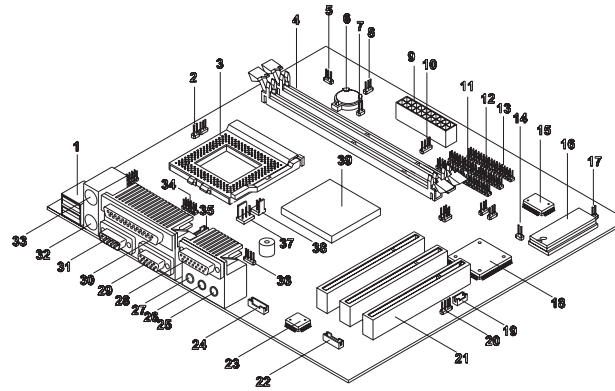

The following table lists the components that you will find on the system board:

No.	Component
1	USB ports
2	CPU temperature sensor connector
3	CPU socket
4	DIMM sockets
5	Turbo LED connector
6	Battery
7	Reset button connector
8	Power LED connector

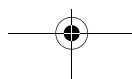
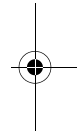
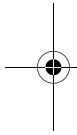



28 Chapter 2
System Board Information



No.	Component
9	ATX power supply connector
10	HDD LED connector
11	Floppy disk drive connector
12	IDE 1 connector
13	IDE 2 connector
14	Intrusion alarm connector
15	System BIOS chip
16	Super I/O controller
17	Power button connector
18	South bridge controller
19	Wake-on LAN connector
20	Modem ring-in connector
21	PCI slots
22	Voice modem connector
23	Audio controller
24	CD-in connector
25	Microphone-in connector
26	Line-in connector
27	Line-out connector
28	Game/MIDI port
29	VGA port
30	Parallel port

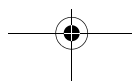
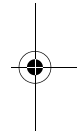
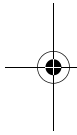

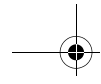

No.	Component
31	COM 2 port
32	PS/2 keyboard port
33	PS/2 mouse port
34	COM 1 connector
35	Speaker connector
36	PC speaker connector
37	3-pin CPU fan connector
38	2-pin CPU fan connector
39	North bridge controller

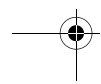
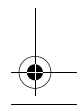
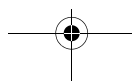
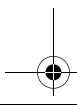
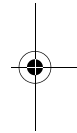
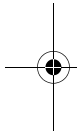

Jumpers and Connectors

Refer to the following figure for the location of the jumpers and connectors on the system board:

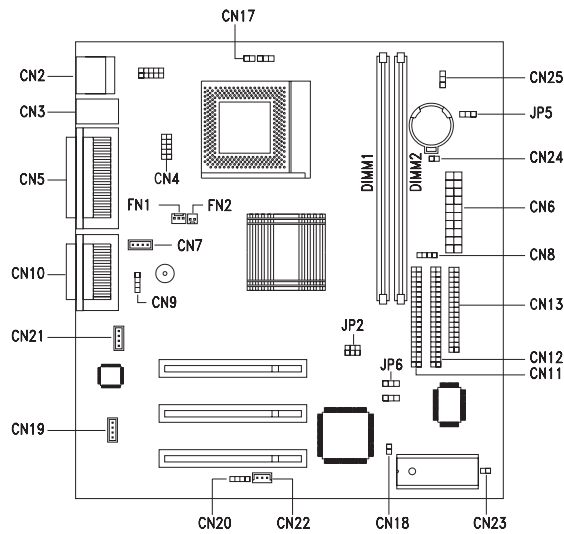

The following table lists the onboard jumpers, their respective functions and possible settings:

Jumper	Function and Settings
JP2	CPU/DRAM Frequency 1-2, 4-5 100/100 MHz 2-3, 5-6 66/100 MHz (default)
JP6	Password Check 1-2 Check password 2-3 Bypass password (default)

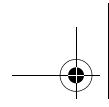

The following table lists the onboard connectors and their respective functions:

Connector	Function
CN2	USB
CN3	Upper port: mouse; Lower port: keyboard
CN4	COM 1
CN5	Upper: parallel/printer; Lower left: COM 2; Lower right: VGA
CN6	ATX power
CN7	Speaker
CN8	Hard disk drive (HDD) light emitting diode (LED)
CN9	PC speaker
CN10	Upper: game/MIDI; Lower left: line-out ; Lower center: line-in, Lower right: microphone-in
CN11	IDE 2
CN12	IDE 1
CN13	Floppy disk drive (FDD)
CN17	CPU temperature sensor
CN18	Intrusion alarm detector
CN19	Voice modem
CN20	Modem ring-in
CN21	CD-in
CN22	Wake-on LAN (WOL)
CN23	Power button

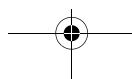
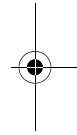
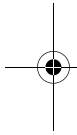

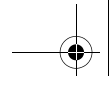

32 Chapter 2
System Board Information



Connector	Function
CN24	Reset button
CN25	Turbo LED
DIMM 1, DIMM 2	Memory module sockets
FN1	3-pin CPU fan
FN2	2-pin CPU fan
JP5	Power LED

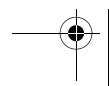
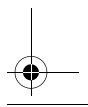
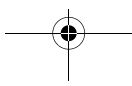
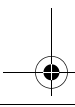
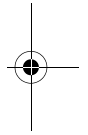
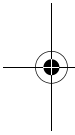

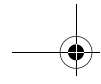

Floppy Disk/Hard Disk Support

The board comes with an enhanced PCI IDE controller that supports PIO mode 4 and Ultra DMA (Direct Memory Access) mode data transfers. Two PCI IDE interfaces are mounted on the board to enable the system to support a maximum of four IDE hard disks, or any other IDE devices. See “Jumpers and Connectors” on page 30 for the location of the IDE interfaces.

Connect the cables according to the IDE hard disk configuration listed in the table below. Follow the instructions in the housing installation manual on how to install a hard disk in the system.

IDE Connector	Master	Slave
IDE 1 (CN12)	Hard disk 0	Hard disk 1
IDE 2 (CN11)	Hard disk 2/IDE CD-ROM	Hard disk 3

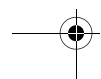
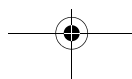
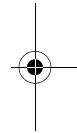
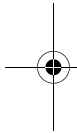

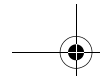

Video Function

The system board comes with a 3-D super AGP video accelerator embedded in the North bridge controller. The AGP bus architecture is considered to be the best solution for 3-D applications because its greater bandwidth is capable of speeding up the VGA bus to better meet the requirements of 3-D applications.

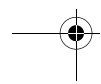
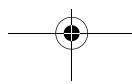
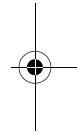
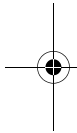

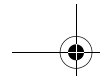

Audio Function

For its audio solution, the board comes with a PCI-based audio controller and the following ports (CN10):

- Mono microphone port
- Stereo line-in port
- Stereo line-out port
- Game/MIDI port

These connectors enable the system to accommodate external audio devices. For instructions on how to connect the external audio devices, see “Connecting Multimedia Components” on page 11.

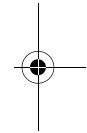
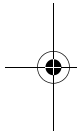

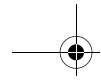

USB Support

USB is a new serial bus design that is capable of cascading low and medium-speed peripherals (less than 12 Mbps) such as a keyboard, mouse, joystick, scanner, printer and modem/ISDN. With USB, complex cable connections at the back panel of your PC can be eliminated.

The board comes with two USB ports (CN2). See “Jumpers and Connectors” on page 30 for the location of the ports.

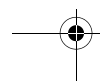
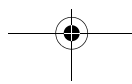
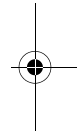
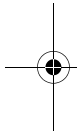



Hardware Monitoring Function

The Hardware Monitoring function allows you to check the system resources, either locally or in a computer network, by using software such as Acer ADM (Advanced Desktop Manager). Acer ADM is a desktop management program that offers SMART (System Monitoring Analysis and Reporting Technology) for checking local or network connected systems. In addition, it also enables the PC hardware and applications to be OS (operating system) independent.

To enable the Hardware Monitoring function, you need to install Acer ADM. Contact your dealer for information on the availability of the software. Refer to the software documentation for more details on the Hardware Monitoring function.

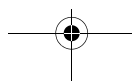
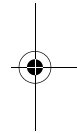
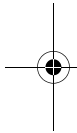

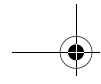

Modem Ring-in Function

The Modem Ring-in function enables the system to resume from suspend mode by monitoring the fax/modem (or any device of similar type) activities. Any signal or activity detected from the Modem ring-in connector automatically returns the system to normal operation. Refer to "Jumpers and Connectors" on page 30 for the location of the Modem ring-in connector (CN20) on the system board.

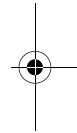
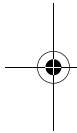

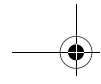

Wake-on LAN

The Wake-on LAN (WOL) feature is a special feature that allows the system to be activated by a network connection via the onboard WOL connector (CN22). Aside from WOL, common network functions such as remote access, file sharing, etc. are also supported.

Refer to “Jumpers and Connectors” on page 30 for the location of the WOL connector (CN22) on the system board.

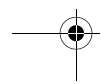
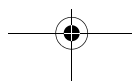
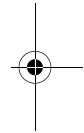
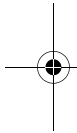

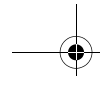

40 Chapter 2
System Board Information

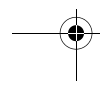
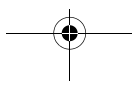
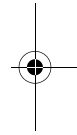
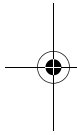

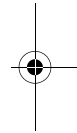
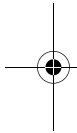
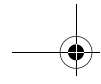

BIOS Information

Chapter 3

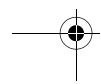
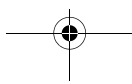

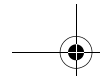

This chapter contains detailed discussion about the BIOS utility. You will need this information for reconfiguring your system or for resetting your system back to its original settings in case you have reconfigured it improperly.

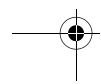
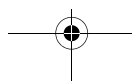
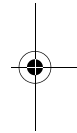
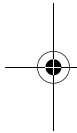

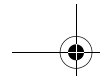

The BIOS Utility is a hardware configuration program built into your system's Basic Input/Output System (BIOS).

Since most systems are already properly configured and optimized, there is no need to run this utility. However, if you encounter configuration problems and get the "Run Setup" message, you will need to run this utility.

Before you run Setup, make sure that you have saved all open files. The system reboots immediately after you exit Setup.



.....
Note: *If you repeatedly receive Run Setup messages, the battery may be bad. In this case, the system cannot retain configuration values in CMOS. Ask a qualified technician for assistance.*

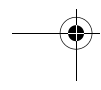
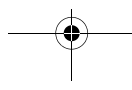
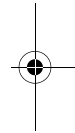
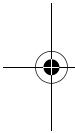



Entering Setup

To enter Setup, press the key combination **Ctrl-Alt-Esc**.



Important! You must press *Ctrl-Alt-Esc* simultaneously while the system is booting. This key combination does not work during any other time.

The Setup Utility main menu then appears:

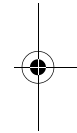
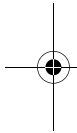
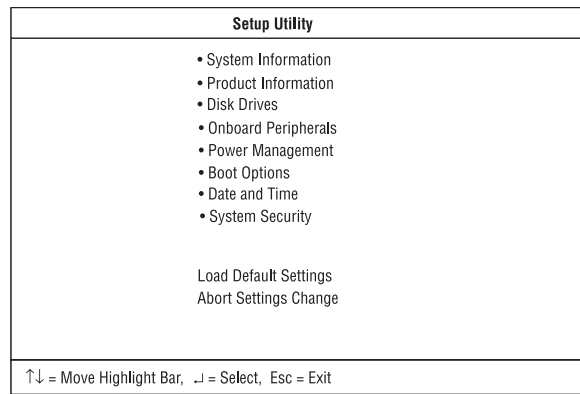

The system supports two BIOS Utility levels: Basic and Advanced. The above screen is the BIOS Utility Basic Level screen. It allows you to view and change only the basic configuration of your system.

If you are an advanced user, you may want to check the detailed configuration of your system. Detailed system configurations are contained in the Advanced Level. To view the Advanced Level, press the **F8** key.

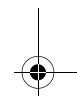
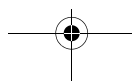
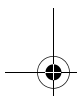



The following screen shows the Setup Utility Advanced Level main menu:

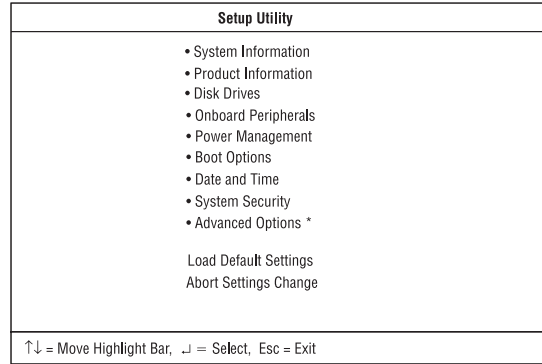

Note: The F8 key works only when you are in the main menu. This means that you can activate the Advanced Level only when you are in the main menu. Also, items marked by an (*) are only visible in the Advanced Level.

The command line at the bottom of the menu tells you how to move within a screen and from one screen to another.

- To select an option, move the highlight bar by pressing ↓ or ↑ then press **Enter**.
- Press **PgDn** to move to the next page or **PgUp** to return to the previous page.
- To change a parameter setting, press ← or → until the desired setting is found.
- Press **Esc** to return to the main menu. If you are already in the main menu, press **Esc** again to exit Setup.

The parameters on the screens show default values. These values may not be the same as those in your system.

The grayed items on the screens have fixed settings and are not user-configurable.

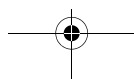
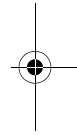
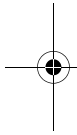



System Information

The following screen appears if you select System Information from the main menu:

System Information		Page 1/2
Processor.....	Celeron™	
Processor Speed.....	366 MHz	
Internal Cache Size.....	32 KB, Enabled	
External Cache Size.....	128KB, Enabled	
Floppy Drive A.....	1.44 MB, 3.5-inch	
Floppy Drive B.....	None	
IDE Primary Channel Master.....	Hard Disk, 6180 MB	
IDE Primary Channel Slave.....	None	
IDE Secondary Channel Master.....	None	
IDE Secondary Channel Slave.....	None	
Total Memory.....	64 MB	
1st Bank.....	SDRAM, 32 MB	
2nd Bank.....	SDRAM, 32 MB	
PgDn/PgUp = Move Screen, Esc = Back to Main Menu		

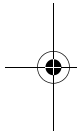

The following screen shows page 2 of the System Information menu:

System Information		Page 2/2
Serial Port 1.....	3F8h, IRQ 4	
Serial Port 2.....	2F8h, IRQ 3	
Parallel Port.....	378h, IRQ 7	
PS/2 Mouse.....	Installed	
PgDn/PgUp = Move Screen, Esc = Back to Main Menu		

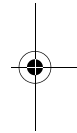

These pages show the current basic configuration of your system.

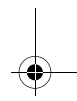
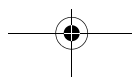
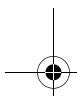

The following table describes each System Information parameter:

Parameter	Description	Format
Processor	Specifies the type of processor currently installed in your system.	
Processor Speed	Specifies the speed of the processor currently installed in your system.	Speed in MHz
Internal Cache Size	Specifies the first-level or the internal memory (i.e., the memory integrated into the CPU) size, and whether it is enabled or disabled.	Cache size in KB
External Cache Size	Specifies the second-level cache memory size currently supported by the system.	Cache size in KB
Floppy Drive A	Shows the floppy drive A type.	Capacity, dimension
Floppy Drive B	Shows the floppy drive B type.	Capacity, dimension
IDE Primary Channel Master	Specifies the current configuration of the IDE device connected to the master port of the primary IDE channel.	Drive type, capacity
IDE Primary Channel Slave	Specifies the current configuration of the IDE device connected to the slave port of the primary IDE channel.	Drive type, capacity
IDE Secondary Channel Master	Specifies the current configuration of the IDE device connected to the master port of the secondary IDE channel.	Drive type, capacity

48 Chapter 3 BIOS Information

Parameter	Description	Format
IDE Secondary Channel Slave	Specifies the current configuration of the IDE device connected to the slave port of the secondary IDE channel.	Drive type, capacity
Total Memory	Specifies the total amount of onboard memory. The memory size is automatically detected by BIOS during the POST. If you install additional memory, the system automatically adjusts this parameter to display the new memory size.	Memory size in MB
1st Bank	Indicates the type of DRAM installed in the DIMM 1 socket. The None setting indicates that there is no DRAM installed.	DIMM type, capacity in MB
2nd Bank	Indicates the type of DRAM installed in the DIMM 2 socket. The None setting indicates that there is no DRAM installed.	DIMM type, capacity in MB
Serial Port 1	Shows the serial port 1 address and IRQ settings.	Address, IRQ
Serial Port 2	Shows the serial port 2 address and IRQ settings.	Address, IRQ
Parallel Port	Shows the parallel port address and IRQ settings.	Address, IRQ
PS/2 Mouse	Indicates if there is a mouse connected to your system. This is automatically detected by BIOS.	Displays Installed if there is a mouse detected; otherwise, it displays None.



Product Information

The screen below appears if you select Product Information from the main menu:

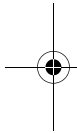
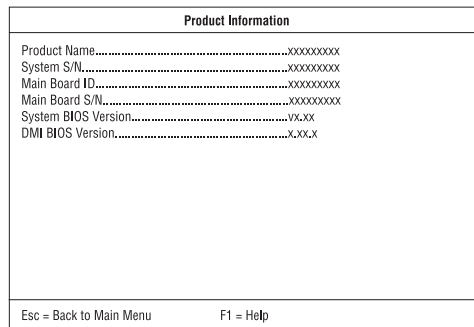

The Product Information menu contains general data about the system, such as the product name, serial number, BIOS version, etc. This information is necessary for troubleshooting (may be required when asking for technical support).

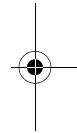

The following table describes the parameters found in this menu:

Parameter	Description
Product Name	Displays the model name of your system
System S/N	Displays your system's serial number
Main Board ID	Displays the system board's identification number
Main Board S/N	Displays your system board's serial number
System BIOS Version	Specifies the version of your BIOS utility

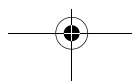

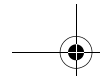

50 Chapter 3
BIOS Information



Parameter	Description
DMI BIOS version	Specifies the version of the DMI BIOS utility installed in your system. The Desktop Management Interface (DMI) BIOS allows you to check your system hardware components without actually opening your system. Hardware checking is done via software during start up.

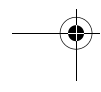
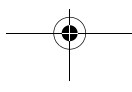
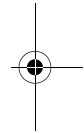
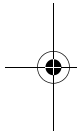

Disk Drives

Select Disk Drives from the main menu to configure the drives installed in your system.

The following screen shows the Disk Drives menu:

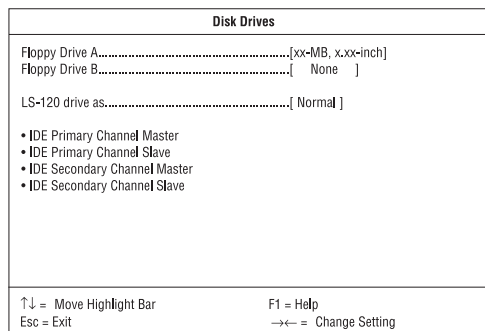

The following table describes the parameters found in this menu. Settings in **boldface** are the default and suggested settings.

Parameter	Description	Options
Floppy Drive A / B	Allows you to configure your floppy drive(s).	None 360 KB, 5.25-inch 1.2 MB, 5.25-inch 720 KB, 3.5-inch 1.44 MB, 3.5-inch 2.88 MB, 3.5-inch
LS-120 drive as	Allows you to enable the LS-120 device installed in your system and to specify the function of the device. The setting affects how BIOS will detect the device.	Normal Drive A Drive B Hard Disk
IDE Primary Channel Master	Allows you to configure the hard disk drive connected to the master port of IDE channel 1.	



52 Chapter 3
BIOS Information



Parameter	Description	Options
IDE Primary Channel Slave	Lets you configure the hard disk drive connected to the slave port of IDE channel 1.	
IDE Secondary Channel Master	Allows you to configure the hard disk drive connected to the master port of IDE channel 2.	
IDE Secondary Channel Slave	Lets you configure the hard disk drive connected to the slave port of IDE channel 2.	

The following screen appears if you select any of the IDE Drive parameters:

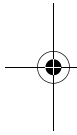

IDE Primary/Secondary Channel Master/Slave	
Type.....	[Auto]
Cylinder.....	[xxxx]
Head.....	[xxxx]
Sector.....	[xxxx]
Size.....	[XXXX] MB
Hard Disk Size > 504 MB.....	[Auto]
*Hard Disk Block Mode.....	[Auto]
*Advanced PIO Mode.....	[Auto]
*Hard Disk 32-bit Access.....	[Enabled]
*DMA Transfer Mode.....	[Auto]
.	
↑↓ = Move Highlight Bar	F1 = Help
Esc = Exit	→← = Change Setting

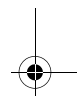
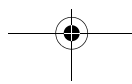
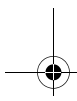
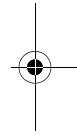

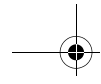

The following table describes the parameters found in these submenus. Settings in **boldface** are the default and suggested settings.

Parameter	Description	Options
Type	Lets you specify the type of hard disk installed in your system. If you want BIOS to automatically configure your hard disk, select Auto. If you know your hard disk type, you can enter the setting manually. Setting this parameter also sets the Cylinder, Head, Sector, and Size parameters.	Auto , None, or User. The User setting allows you to enter your settings manually if you know your hard disk type. The Auto setting also sets the Cylinder, Head, Sector, and Size parameters.
Cylinder	Specifies your hard disk's number of cylinders, and is automatically set depending on your Type parameter setting.	
Head	Specifies your hard disk's number of heads, and is automatically set depending on your Type parameter setting.	
Sector	Specifies your hard disk's number of sectors, and is automatically set depending on your Type parameter setting.	
Size	Specifies the size of your hard disk, in MB, and is automatically set depending on your type parameter setting.	
Hard Disk Size > 504 MB	Enables your system to support hard disks with capacities more than 504 MB.	Auto or Disabled

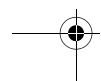
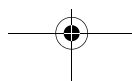
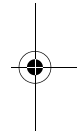
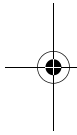



54 Chapter 3
BIOS Information



Parameter	Description	Options
Hard Disk Block Mode	Enhances your hard disk performance by allowing data transfer in blocks (multiple sectors) at a rate of 256 bytes per cycle. This parameter appears only in the Advanced Level.	Auto or Disabled
Advanced PIO Mode	Improves your hard disk performance by allowing faster data recovery and read/write timing; thus, it reduces the hard disk's activity time. This parameter appears only in the Advanced Level.	Auto or Mode 0 to 4
Hard Disk 32-bit Access	Improves your hard disk performance by allowing the use of the 32-bit hard disk access. This parameter appears only in the Advanced Level.	Enabled or Disabled
DMA Transfer Mode	Lets you enable the Ultra DMA and Multi-DMA modes to enhance your hard disk performance. This parameter appears only in the Advanced Level.	Auto , Multi Mode 0 to 2, or Ultra Mode 0 to 2

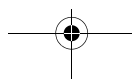
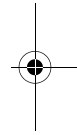
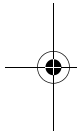

Onboard Peripherals

The Onboard Peripherals menu allows you to configure the onboard devices. Selecting this option from the main menu displays the following screen:

Onboard Peripherals	
Serial Port 1.....	[Enabled]
Base Address.....	[3F8h]
IRQ.....	[4]
Serial Port 2.....	[Enabled]
Base Address.....	[2F8h]
IRQ.....	[3]
Parallel Port.....	[Enabled]
Base Address.....	[378h]
IRQ.....	[7]
Operation Mode.....	[Bi-directional]
ECP DMA Channel.....	[-]
• Onboard Device Settings	
↑↓ = Move Highlight Bar	F1 = Help
Esc = Exit	→← = Change Setting

The following table describes the parameters found in this menu. Settings in **boldface** are the default and suggested settings.

Parameter	Description	Options
Serial Port 1 / 2	Let you enable or disable the serial ports.	Enabled or Disabled
Base Address	Lets you set a logical base address for each serial port. This parameter is configurable only if the Serial Port parameter is enabled.	3F8h (for serial port 1), 2F8h (for serial port 2), 2E8h, 3E8h
IRQ	Lets you assign an interrupt for each serial port. This parameter is configurable only if the Serial Port parameter is enabled.	4 or 11 (for serial port 1), 3 or 10 (for serial port 2)

56 Chapter 3
BIOS Information

Parameter	Description	Options
Parallel Port	Lets you enable or disable the parallel port.	Enabled or Disabled
Base Address	Lets you set a logical base address for the parallel port. This parameter is configurable only if the Parallel Port parameter is enabled.	3BCh, 378h , 278h
IRQ	Lets you assign an interrupt for the parallel port. This parameter is configurable only if the Parallel Port parameter is enabled.	5 or 7
Operation Mode	Lets you set your parallel port's operation mode. This parameter is configurable only if the Parallel Port parameter is enabled.	Standard Parallel Port (SPP), Bidirectional , Enhanced Parallel Port (EPP), Extended Capabilities Port (ECP)
ECP DMA Channel	Allows you to assign a DMA channel for the ECP parallel port function. This parameter is configurable only if you select the Extended Capabilities Port (ECP) as the operation mode.	1 or 3
Onboard Device Settings	Allows you to configure the onboard device controllers. Selecting this option displays the Onboard Device Settings submenu.	



Onboard Device Settings

The following screen shows the Onboard Device Settings submenu:

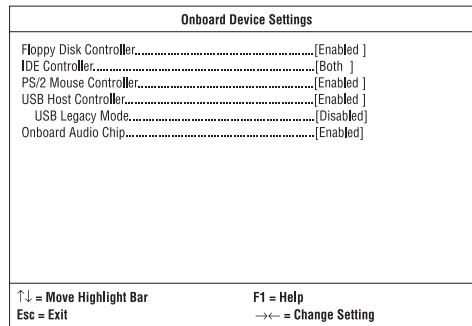

The following table describes the parameters found in this submenu. Settings in **boldface** are the default and suggested settings.

Parameter	Description	Options
Floppy Disk Controller	Lets you enable or disable the onboard floppy disk controller.	Enabled or Disabled
IDE Controller	Lets you enable or disable the onboard primary, secondary or both IDE interfaces.	Primary, Secondary, Both , or Disabled
PS/2 Mouse Controller	Lets you enable or disable the onboard PS/2 mouse controller.	Enabled or Disabled
USB Host Controller	Lets you enable or disable the onboard USB host controller.	Enabled or Disabled



58 Chapter 3
BIOS Information



Parameter	Description	Options
USB Legacy Mode	Lets you activate or deactivate the USB keyboard connected to your system. When activated, the USB keyboard functions in a DOS environment.	Enabled or Disabled
Onboard Audio Chip	Lets you activate or deactivate the onboard audio controller.	Enabled or Disabled

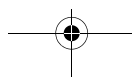
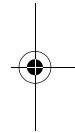
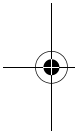

Power Management

The Power Management menu lets you configure the system power-management feature.

The following screen shows the Power Management parameters and their default settings:

Power Management	
Power Management Mode.....	[Enabled]
IDE Hard Disk Standby Timer.....	[Off] Minute(s)
System Sleep Timer.....	[Off] Minute(s)
Sleep Mode.....	[-----]
Power Switch < 4 Sec.....	[Power Off]
System Wake-Up Event	
Modem Ring Indicator.....	[Enabled]
↑↓ = Move Highlight Bar F1 = Help Esc = Exit →← = Change Setting	

The following table describes the parameters found in this menu. Settings in **boldface** are the default and suggested settings.

Parameter	Description	Options
Power Management Mode	Allows you to reduce the system's power consumption. When enabled, the IDE hard disk and system timers become configurable.	Enabled or Disabled
IDE Hard Disk Standby Timer	Allows the hard disk to enter Standby mode after inactivity of 1 to 15 minutes, depending on your setting.	1 to 15 minutes, or Off



60 Chapter 3
BIOS Information



Parameter	Description	Options
System Sleep Timer	Automatically puts the system to power-saving mode after a specified period of inactivity. Any keyboard or mouse action, or any activity detected from the IRQ channels resumes system operation.	2, 5, 10, 15, 20, 30, 40, 50...120 minutes, or Off
Sleep Mode	Lets you specify the power-saving mode that the system will enter after a specified period of inactivity. This parameter is configurable only if the System Sleep Timer is enabled.	Standby or Suspend
Power Switch < 4 sec.	Lets you specify whether to automatically turn off the machine or put the system to Suspend mode when the power switch is pressed for less than 4 seconds.	Power Off or Suspend
System Wake-up Event	Lets you specify the activity that will resume the system to normal operation.	
Modem Ring Indicator	Wakes the system from Sleep mode once any fax/modem activity is detected.	Enabled or Disabled

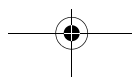
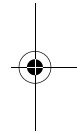
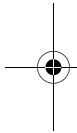



Boot Options

This option allows you to specify your preferred settings for bootup.

The following screen appears if you select **BOOT Options** from the main menu:

Boot Options	
Boot Sequence	
1st [Floppy Disk]	
2nd [Hard Disk]	
3rd [IDE CD-ROM]	
First Hard Disk Drive.....	[IDE]
Primary Display Adapter.....	[Auto]
Fast Boot.....	[Auto]
Silent Boot.....	[Enabled]
Num Lock After Boot.....	[Enabled]
Memory Test.....	[Disabled]
*Configuration Table.....	[Enabled]
*Update BIOS with Boot Block.....	[Disabled]
↑↓ = Move Highlight Bar F1 = Help	
Esc = Exit →← = Change Setting	

The following table describes the parameters found in this menu. Settings in **boldface** are the default and suggested settings.

Parameter	Description	Options
Boot Sequence	Allows you to specify the boot search sequence.	Floppy Disk, Hard Disk, IDE CD-ROM
First Hard Disk Drive	Specifies whether the BIOS utility will boot from an IDE hard disk or a SCSI hard disk drive.	IDE or SCSI
Primary Display Adapter	Lets you activate the onboard video controller as your primary display adapter, or automatically disable it once BIOS detects that there is a video card installed in your system.	Onboard or Auto

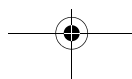
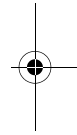
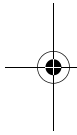

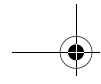

62 Chapter 3
BIOS Information



Parameter	Description	Options
Fast Boot	Allows you to define your system's booting process, whether to skip some POST routines or proceed with the normal booting process.	Auto or Disabled
Silent Boot	When enabled, BIOS is in graphical mode and displays only an identification logo during POST and while booting. Then, the screen displays the operating system prompt (as in DOS) or logo (as in Windows). If any error occurs while booting, the system automatically switches to the text mode. You may also switch to the text mode while booting by pressing F9 after you hear a beep that indicates the activation of the keyboard.	Enabled or Disabled
Num Lock After Boot	Allows you to activate or deactivate the Num Lock function upon booting.	Enabled or Disabled
Memory Test	Lets you specify whether you want BIOS to perform or bypass the RAM test during POST.	Enabled or Disabled

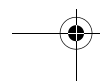
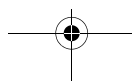
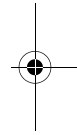
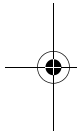

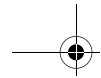

Parameter	Description	Options
Configuration Table	Allows you to enable or disable the display of the configuration table after POST but before booting. The configuration table gives a summary of the hardware devices and settings that BIOS detected during POST. This parameter appears only when you are in the Advanced Level.	Enabled or Disabled
Update BIOS with Boot Block	When enabled, it allows you to replace the existing BIOS in the Flash ROM by simply inserting the floppy disk containing the new BIOS into the floppy drive then resetting the system. After reset, the system will automatically read the BIOS file contained on the floppy disk (i.e., the first file on the disk) and replace the BIOS in the Flash ROM. If the update is successful, the system will automatically disable this parameter then shut down. This parameter appears only when you are in the Advanced Level.	Enabled or Disabled

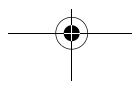
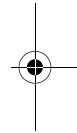
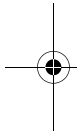



Date and Time

The following screen appears if you select the Date and Time option from the main menu:

Date and Time	
Date.....	[WWW MMM DD, YYYY]
Time.....	[HH:MM:SS]
↑↓ = Move Highlight Bar F1 = Help Esc = Exit →← = Change Setting	

The following table describes the parameters found in this menu:

Parameter	Description	Options
Date	Lets you set the date following the weekday-month-day-year format.	Weekday: Sun, Mon, Tue, Wed, Thu, Fri, Sat Month: Jan, Feb...Dec Day: 1 to 31 Year: 1980 to 2079
Time	Lets you set the time following the hour-minute-second format.	Hour: 0 to 23 Minute: 0 to 59 Second: 0 to 59

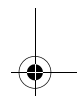
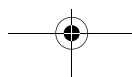
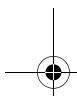
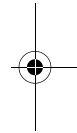
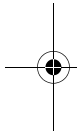

System Security

The Setup program has a number of security features to prevent unauthorized access to the system and its data.

The following screen appears if you select System Security from the main menu:

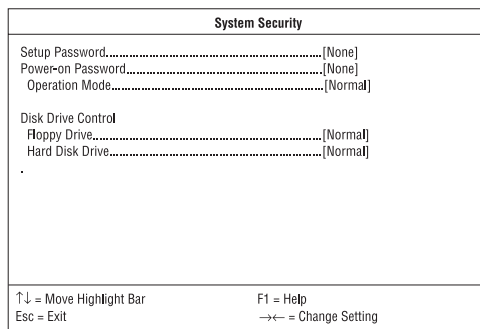

The following table describes the parameters found in this menu. Settings in **boldface** are the default and suggested settings.

Parameter	Description	Options
Setup Password	Prevents unauthorized access to the BIOS utility.	None or Present. The Present setting allows you to set a Setup password. For instructions on how to set a Setup password, refer to "Setting a Password" on page 67.



Parameter	Description	Options
Power-on Password	Secures your system against unauthorized use. Once you set this password, you have to type it whenever you boot the system.	None or Present. The Present settings allows you to set a Power-on password. For instructions on how to set a Power-on password, refer to "Setting a Password" on page 67.
Operation Mode	Lets you enable or disable the password prompt display. When set to Normal, the password prompt appears before system boot. When set to Keyboard Lock, the password prompt does not appear; however, your system will not respond to any keyboard or mouse input until you enter the correct password.	Normal or Keyboard Lock
Disk Drive Control	Allows you to protect your system's floppy drive and hard disk data from being modified (possible under DOS mode only).	
Floppy Drive	Protects your floppy drive data from being modified.	Normal , Write Protect All Sectors, Write Protect Boot Sectors
Hard Disk Drive	Protects your hard disk data from being modified.	Normal , Write Protect All Sectors, Write Protect Boot Sectors

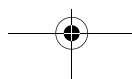
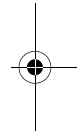
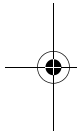

Setting a Password

1. Make sure that **JP6** is set to **2-3** (bypass password).



.....
You cannot enter the BIOS utility if a Setup password does not exist and JP6 is set to 1-2 (password check enabled). By default, JP6 is set to 2-3 (bypass password).

2. Enter the BIOS utility and select System Security.
3. Highlight the Setup Password parameter to set a Setup password, or Power-on Password to set a Power-on password. Then press **←** or **→**. The following screen appears:

Setup Password	
Enter your new Setup Password twice. Setup Password may be up to 7 characters long.	
Enter Password.....[xxxxxxxx]	
Enter Password again.....[xxxxxxxx]	
Set or Change Password	
.....	
↑↓ = Move Highlight Bar Esc = Exit	F1 = Help →← = Change Setting

4. Type a password. The password may consist of up to seven characters. Then press **Enter**.



.....
***Note:** Be very careful when typing your password because the characters do not appear on the screen.*

5. Retype the password then press **Enter**.
6. After setting the password, highlight the Set or Change Password option.
7. Press **Esc** to return to the System Security screen.
8. Press **Esc** to return to the main menu.



9. Press **Esc** to exit the BIOS utility. A dialog box appears asking if you want to save the CMOS data.
10. Select **Yes** to save the changes and reboot the system.
11. After rebooting, turn off the system then open the housing.
12. Set **JP6** to **1-2** to enable the password function.

If you have set a Setup password, the next time you want to enter the BIOS utility, you must key-in your Setup password.

If you have set a Power-on password, you must enter that password every time you boot your system.

Changing or Removing the Password

Should you want to **change one of your passwords**, do the following:

1. Enter the BIOS utility and select System Security.
2. Highlight the Setup Password parameter (for Setup password) or the Power-on Password parameter (for Power-on password). Then press **←** or **→**. The Password menu appears.
3. From the Password menu, highlight the Set or Change Password option.
4. Enter a new password.
5. Press **Esc** to return to the System Security screen.
6. Press **Esc** to return to the main menu.
7. Press **Esc** to exit the BIOS utility. A dialog box appears asking if you want to save the CMOS data.
8. Select **Yes** to save the changes.

To remove the password, simply select the Setup Password parameter (for Setup password) or the Power-on Password parameter (for Power-on password) from the System Security menu and set it to **None**.

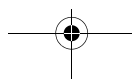
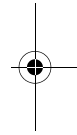
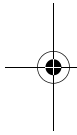

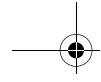

Bypassing the Password

If you forget your password, you can bypass the password security feature by hardware. Follow these steps to bypass the password:

1. Turn off and unplug the system.
2. Open the system housing and set **JP6** to **2-3** to bypass the password function.
3. Turn on the system and enter the BIOS utility. This time, the system does not require you to type in a password.

You can either change the existing password or remove it by selecting **None**. Refer to “Changing or Removing the Password” on page 68 for the procedure.

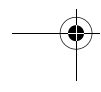
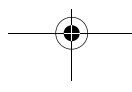
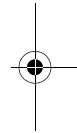
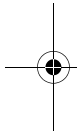



Advanced Options



Note: The Advanced Options selection is available only in the Advanced Level.

The Advanced Options menu allows you to configure the system memory and PCI device settings.

The following screen shows the Advanced Options parameters:

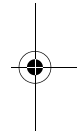
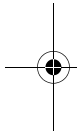
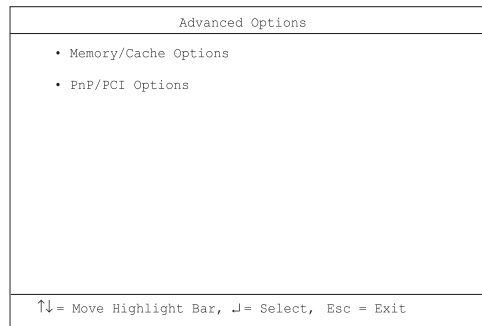

Caution: Do not change any settings in the Advanced Options menu if you are not a qualified technician to avoid damaging the system.

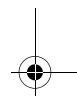
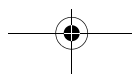
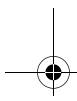

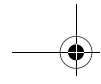

Memory/Cache Options

Selecting Memory/Cache Options from the Advanced Options menu displays the following screen:

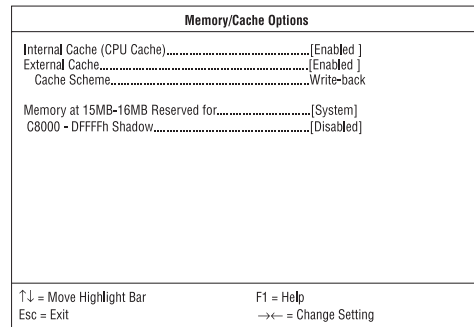

This menu lets you configure the system memory.

The following table describes the parameters found in this submenu. Settings in **boldface** are the default and suggested settings.

Parameter	Description	Options
Internal Cache (CPU Cache)	Lets you enable or disable the primary cache memory, i.e., the CPU memory.	Enabled or Disabled
External Cache	Lets you enable or disable the secondary cache memory.	Enabled or Disabled
Cache Scheme	This parameter is non-configurable and is always set to Write-back. The Write-back mode updates the cache but not the memory when there is a write instruction.	Write-back



72 Chapter 3
BIOS Information



Parameter	Description	Options
Memory at 15MB-16MB Reserved for	To prevent memory address conflicts between the system and expansion boards, reserve this memory range for the use of either the system or an expansion board. Some VGA cards have required settings for this feature. Check your VGA card manual before setting this parameter.	System or Add-on card
C8000 - DFFFFh Shadow	Allows you to shadow an expansion card to ROM. For some legacy ISA LAN cards, you might need to disable shadowing for proper operation. In such case, we recommend that you set this parameter to Disabled.	Enabled or Disabled

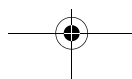
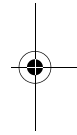
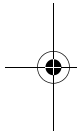

PnP/PCI Options

The PnP/PCI Options allows you to specify the settings for your PCI devices. Selecting this option displays the following screen:

PnP/PCI Configuration				
PCI IRQ Setting.....	[Auto]			
	INTA	INTB	INTC	INTD
PCI Slot 1.....	[-]	[-]	[-]	[-]
PCI Slot 2.....	[-]	[-]	[-]	[-]
PCI Slot 3.....	[-]	[-]	[-]	[-]
PCI IRQ Sharing.....	[Yes]			
VGA Palette Snoop.....	[Disabled]			
Plug and Play OS.....	[Yes]			
Reset Resource Assignments.....	[No]			
↑↓ = Move Highlight Bar F1 = Help Esc = Exit →← = Change Setting				

The following table describes the parameters found in this submenu. Settings in **boldface** are the default and suggested settings.

Parameter	Description	Options
PCI IRQ Setting	Allows you to automatically or manually configure the Plug-and-Play (PnP) devices installed in your system. Refer to your device manual for technical information about the PCI card.	Auto or Manual
PCI Slot 1/2/3	Allow you to manually assign an interrupt for each PCI device installed in your system. When the PCI IRQ Setting is set to Auto, BIOS automatically assigns the available IRQs to the PCI devices.	



74 Chapter 3
BIOS Information



Parameter	Description	Options
PCI IRQ Sharing	Allows you to assign the same IRQ to two different devices.	Yes or No
VGA Palette Snoop	Enables the palette snooping feature if you installed more than one VGA card in the system, allowing the control palette register (CPR) to manage and update the VGA RAM DAC (Digital Analog Converter, a color data storage) of each VGA card installed in the system. The snooping process lets the CPR send a signal to all the VGA cards so that they can update their individual RAM DACs. The signal goes through the cards continuously until all RAM DAC data has been updated. This allows the display of multiple images on the screen. Some VGA cards have required settings for this feature. Check your VGA card manual before setting this parameter.	Enabled or Disabled
Plug and Play OS	Set it to Yes if the computer is running on Win95/98 or Win NT 5.0. For any other OS, set to No.	Yes or No
Reset Resource Assignments	When enabled, avoids IRQ conflicts when installing non-PnP and PnP ISA cards. This clears all resource assignments and allows BIOS to reassign resources to all installed PnP devices the next time the system boots.	Yes or No After clearing the resource data, it is recommended that you reset the parameter to its default, i.e., No.

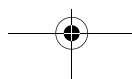
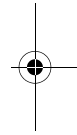
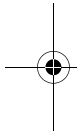

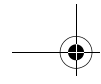

Load Default Settings

You need to reload the BIOS default settings every time you make changes to your system hardware configuration (such as memory size, CPU type, hard disk type, etc.); otherwise, BIOS will keep the previous CMOS settings. Selecting this option displays the following dialog box:

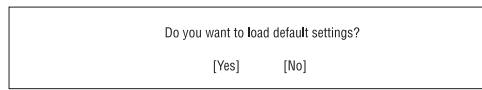

Choosing **Yes** enables BIOS to automatically detect the hardware changes that you have made in your system. This option also allows you to restore the default settings.

Choosing **No** returns you to the main menu without loading the default settings.

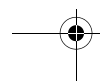
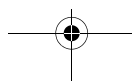
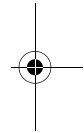
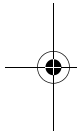

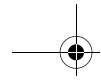

Abort Settings Change

Selecting the Abort Settings Change option from the main menu displays the following dialog box:

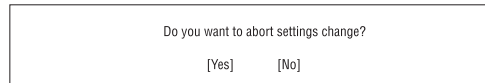

Choosing **Yes** discards all the changes that you have made and reverts the parameters to their previously saved settings.

Choosing **No** returns you to the main menu. BIOS retains all changes that you have made.

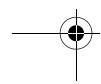
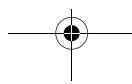
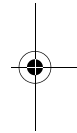
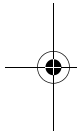

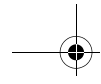

Exiting Setup

To exit the BIOS utility, simply press **Esc**. The following dialog box appears:

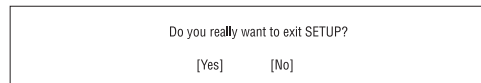

Select **Yes** to exit Setup. Select **NO** to return to the main menu. If you have made changes in the parameter settings, the following dialog box appears:

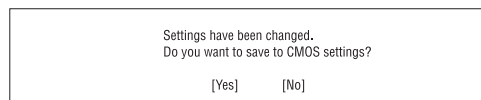

Select **Yes** to save your changes before you exit Setup. Select **NO** to discard all changes and exit Setup.

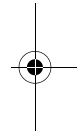
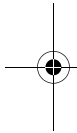

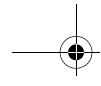

78 Chapter 3
BIOS Information

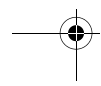
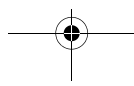
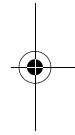
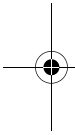

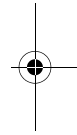
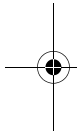
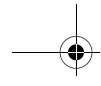

Upgrading the System

Chapter 4

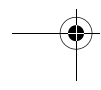
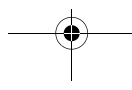

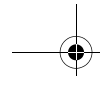

This chapter tells you how to remove and replace the system housing, and to install optional components to upgrade the system. It gives brief and clear instructions accompanied by mechanical illustrations showing how to perform each described procedure.

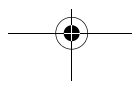
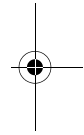
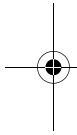



Installation Precautions

Before you install any system component, we recommend that you read the following sections. These sections contain important ESD precautions, pre- and post-installation instructions.

ESD Precautions

Electrostatic discharge (ESD) can damage your processor, disk drives, expansion boards, and other components. Always observe the following precautions before you install a system component.

1. Do not remove a component from its protective packaging until you are ready to install it.
2. Wear a wrist grounding strap and attach it to a metal part of the system unit before handling components. If a wrist strap is not available, maintain contact with the system unit throughout any procedure requiring ESD protection.

Preinstallation Instructions

Always observe the following before you install a system component:

1. Turn off the system power and all the peripherals connected to the unit before opening it.
2. Open the system according to the instructions on page 83.
3. Follow the ESD precautions on page 81 before handling a system component.
4. Remove any expansion boards or peripherals that block access to the DIMM sockets or CPU connector.
5. See the following sections for specific instructions on the component you wish to install.



Warning! Not turning off the system properly before you start installing the components may damage your system.

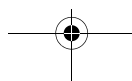
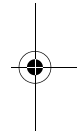
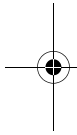



Do not attempt the procedures described in the following sections unless you are a qualified service technician.

Post-installation Instructions

Observe the following after installing a system component:

1. See to it that the components are installed according to the step-by-step instructions in their respective sections.
2. Make sure you have set all the required jumpers. See “Jumpers and Connectors” on page 30 for the correct jumper settings.
3. Replace any expansion boards or peripherals that you removed earlier.
4. Replace the system cover.
5. Connect the necessary cables and turn on the system.

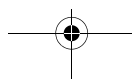
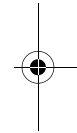
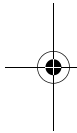

Opening the System



Caution: Before you proceed, make sure that you have turned off the system and all peripherals connected to it. Read the preinstallation instructions on page 81.

This section tells you how to open the housing cover when you need to install additional components inside the system unit.

Removing the Housing Cover

1. Turn off the system power and unplug all cables.
2. Place the system unit on a flat, steady surface.
3. Turn the thumbscrews counterclockwise to remove the cover. Set the screws aside. You will need them when replacing the housing cover.

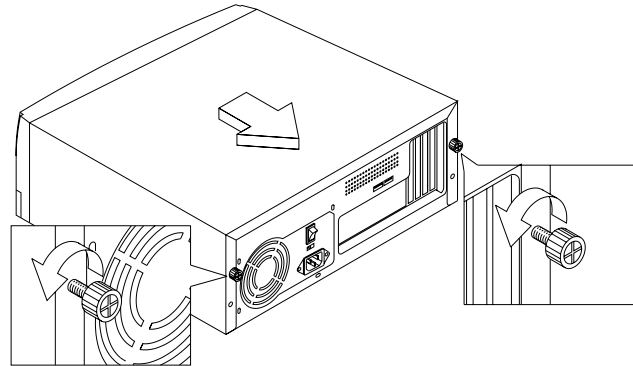

4. Hold the sides of the cover with both hands and slide it back about half an inch and lift up the cover.
5. There are two metal bracket frames inside the housing, refer to "Internal Components" on page 8. Each metal bracket

84 Chapter 4
Upgrading the System

frame can hold two 3.5-inch devices. To remove a metal bracket frame you should first remove the screw that secures the metal bracket frame to the housing.

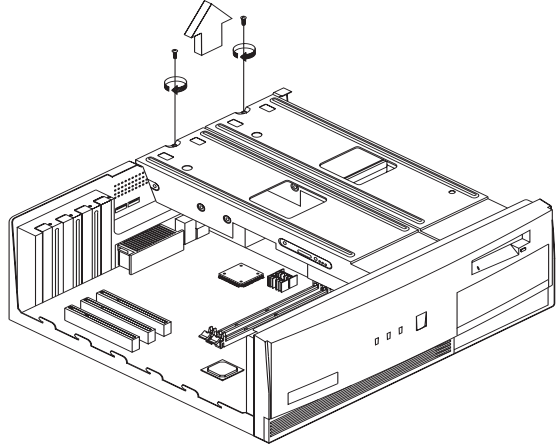

6. To detach the metal bracket frame, lift it up and then gently pull it out.

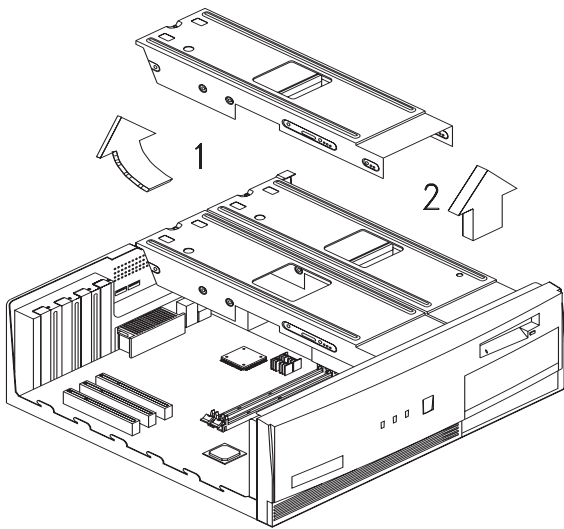

Replacing the Housing Cover

1. Position the top cover on the housing, aligning the sides with the rails. Allow a 10 mm distance between the edge of the cover and the front panel.

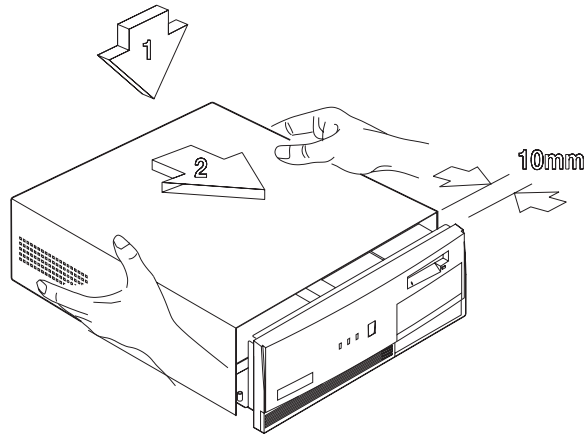

2. Slide the cover forward until it fits into place.

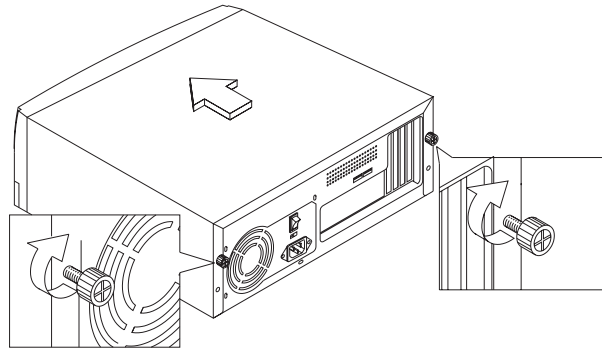

3. Turn the thumbscrews clockwise to secure the cover.



Installing Additional Memory

The system memory is upgradeable to a maximum of 256 MB via two 168-pin DIMM sockets on the system board. These DIMM sockets accept PC-100 compliant DIMMs with 8-, 16-, 32-, 64-, and 128-MB capacities. See “Board Layout” on page 27 for the location of the DIMM sockets. For instructions on how to install DIMMs, refer to “Installing a DIMM” on page 88.

The following table lists the possible memory configurations:

DIMM 1	DIMM 2	Total Memory
8 MB	None	8 MB
16 MB	None	16 MB
32 MB	None	32 MB
64 MB	None	64 MB
128 MB	None	128 MB
None	8 MB	8 MB
None	16 MB	16 MB
None	32 MB	32 MB
None	64 MB	64 MB
None	128 MB	128 MB
8 MB	8 MB	16 MB
8 MB	16 MB	24 MB
8 MB	32 MB	40 MB
8 MB	64 MB	72 MB
8 MB	128 MB	136 MB
16 MB	8 MB	24 MB

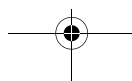
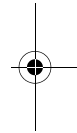
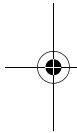



DIMM 1	DIMM 2	Total Memory
16 MB	16 MB	32 MB
16 MB	32 MB	48 MB
16 MB	64 MB	80 MB
16 MB	128 MB	144 MB
32 MB	8 MB	40 MB
32 MB	16 MB	48 MB
32 MB	32 MB	64 MB
32 MB	64 MB	96 MB
32 MB	128 MB	160 MB
64 MB	8 MB	72 MB
64 MB	16 MB	80 MB
64 MB	32 MB	96 MB
64 MB	64 MB	128 MB
64 MB	128 MB	192 MB
128 MB	8 MB	136 MB
128 MB	16 MB	144 MB
128 MB	32 MB	160 MB
128 MB	64 MB	192 MB
128 MB	128 MB	256 MB

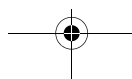
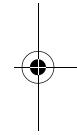
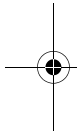



Installing a DIMM

1. Open the clips on the socket.
2. Align the DIMM with the socket.
3. Press the DIMM into the socket until the clips lock into the DIMM.

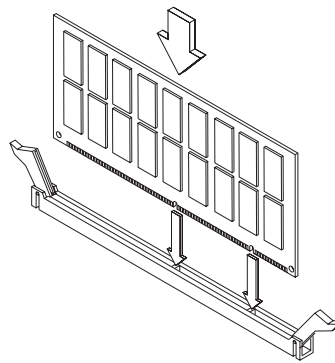

Note: The DIMM socket is slotted to ensure proper installation. If you insert a DIMM but it does not fit easily into the socket, you may have inserted it incorrectly. Turn the DIMM around and try to insert it again.

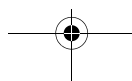
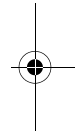
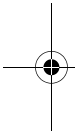



Removing a DIMM

1. Press the holding clips on both sides of the socket outward to release the DIMM.
2. Gently pull the DIMM out of the socket.

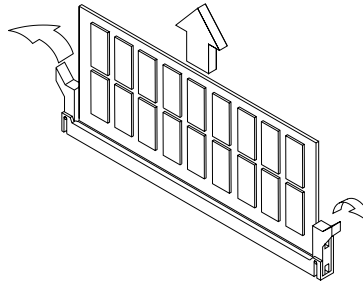

Reconfiguring the System

The system automatically detects the amount of memory installed. Run Setup to view the new value for total system memory and make a note of it.

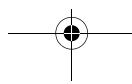
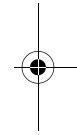
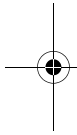

Upgrading the CPU

Removing the CPU



Note: Observe the ESD precautions on page 81 when installing or removing a system component.

Before you can replace or upgrade your processor, you need to remove the previously installed processor on the system board.

Follow these steps to remove the CPU:

1. On the system board, locate the CPU mounted on the socket.
2. Detach the fan/heatsink cable connector.

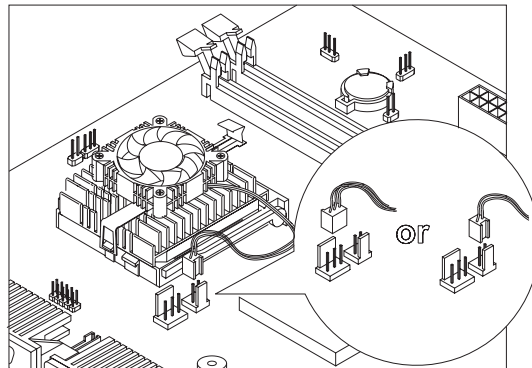

3. Remove the fan/heatsink from the CPU.
4. Pull up the socket lever. The CPU pins will be automatically released from the socket holes.



5. Pull out the CPU from the socket.

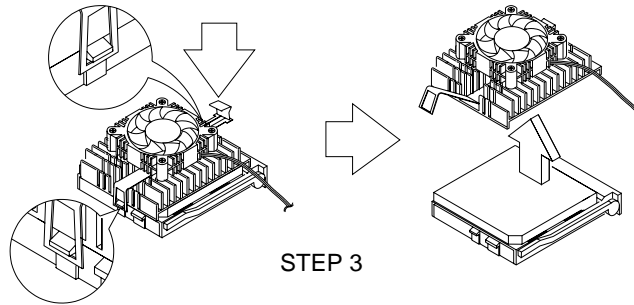

STEP 3

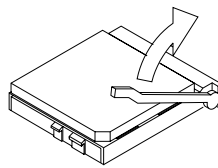

STEP 4

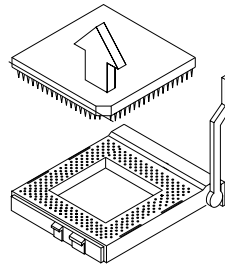

STEP 5

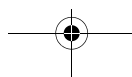
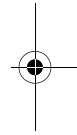
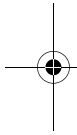

Installing the Upgrade CPU



Note: Observe the ESD precautions on page 81 when installing or removing a system component.

Before you proceed, make sure that there is no CPU installed in the CPU socket.

Follow these steps to install the upgrade CPU:

1. Pull up the socket lever.
2. Insert the CPU, making sure that pin 1 (indicated by a notched corner of the CPU) connects to hole 1 of the socket.
3. Pull down the socket lever to lock the CPU into the socket.

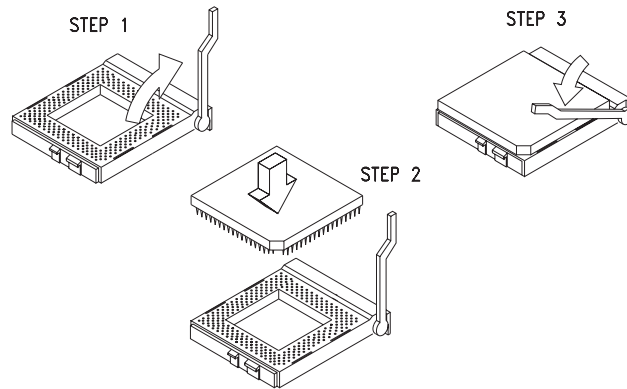

4. Attach the heatsink and fan to the CPU.

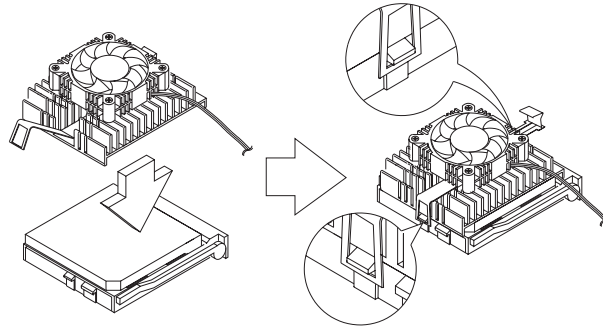

5. Plug the fan/heatsink cable to the fan connector marked FN1 (for 3-pin connector) or FN2 (for 2-pin connector). See “Jumpers and Connectors” on page 30 for the location of the connectors on the system board.

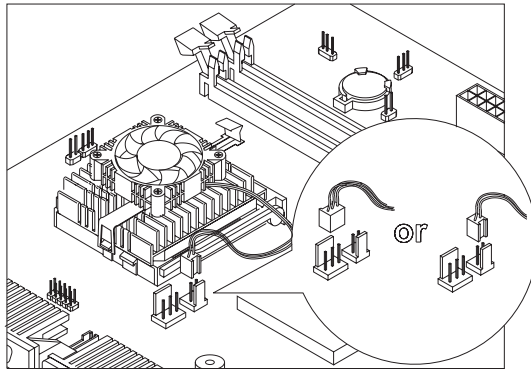

Warning! The heatsink becomes very hot when the system is on. Never touch the heatsink with any metal or with your hands.

Replacing the Hard Disk

Follow these steps to replace the hard disk drive:

1. Remove the cover as shown on page 83.
2. Remove the metal bracket frame holding the hard disk.
3. Lift the metal bracket frame as shown below and disconnect all cables connected to the hard disk and 3.5-inch diskette drives.

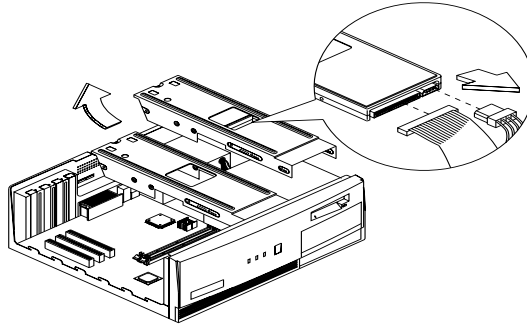

4. Remove the four screws that hold the hard disk to the metal bracket frame and pull out the hard disk drive.

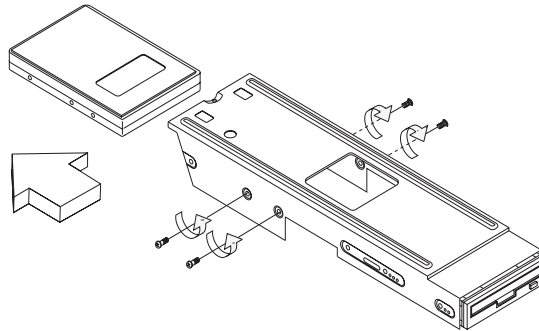

5. Install a new 3.5-inch hard disk drive and secure it with the four screws that you have removed previously.

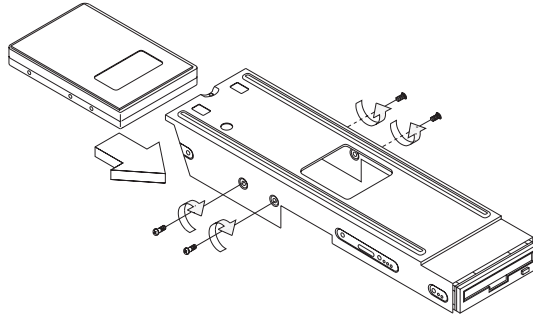

6. Reattach the metal bracket frame and secure it with the screw.
7. Connect the disk drive cables and power cables.

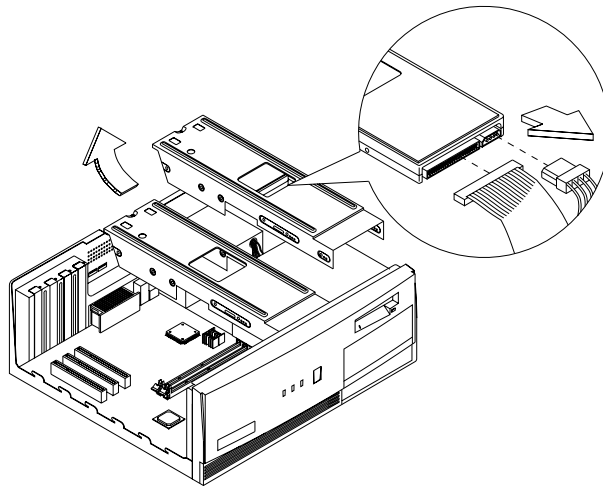

8. Reinstall the housing cover as shown on page 85.



Make sure that the other ends of the diskette drive cables are securely connected to their corresponding connectors on the system board.

Installing and Removing a PCI Card

Installing a PCI Card

1. Locate an empty PCI slot on the system board.
2. Remove the bracket on the housing opposite the selected empty PCI slot.

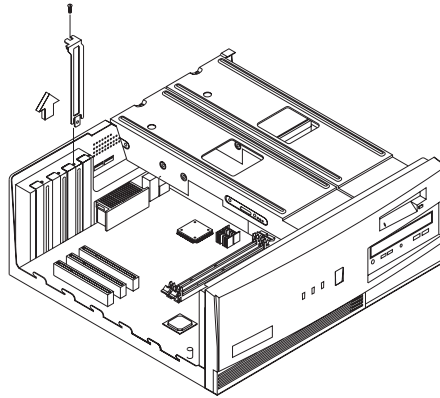

3. Remove the PCI card from its protective packaging.
4. Align then insert the PCI card into the slot. Make sure that the card is properly seated.

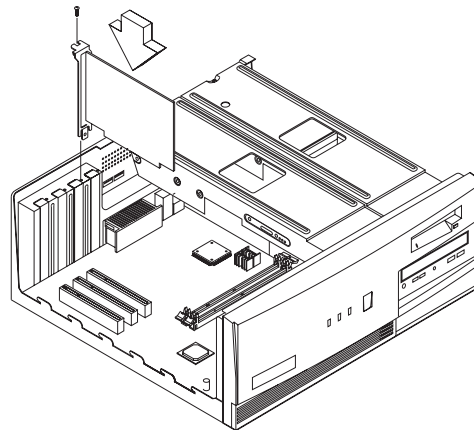

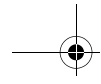

5. Secure the card to the housing with a screw.
6. Reinstall the housing cover (see page 85).

When you turn on the system, BIOS automatically detects and assigns resources to the PCI devices.

Removing a PCI Card

To remove a PCI card, simply reverse the instructions listed under the “Installing a PCI Card” section.

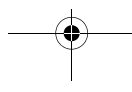
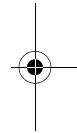
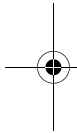

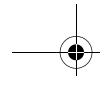

98 Chapter 4
Upgrading the System

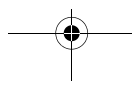
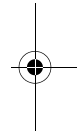
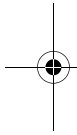

Index

A

- abort settings change 76
- ACPI 26
- Advanced level 44
- Advanced Options 70
 - PnP/PCI 73
- AGP 3
- audio function 35
 - controller 35
 - ports 35

B

- Basic level 44
- BIOS utility 43–77
- board layout 27
- Boot Options 61
 - boot sequence 61
 - configuration table 63
 - fast boot 62
 - first hard disk drive 61
 - memory test 62
 - Num Lock after boot 62
 - primary display adapter 61
 - silent boot 62
 - update BIOS with boot block 63

C

- C8000-DFFFh Shadow 72
- computer
 - performance 25
- connecting components 9
 - fax 12
 - keyboard 9
 - modem 12
 - monitor 10
 - mouse 10
 - network 12
 - printer 11
- connectors 30, 31
- CPU upgrade 90
 - installing 92
 - removing 90

D

- Date and Time 64
- Desktop Management Interface 26

- DIMM 25

- DIMM installation 88

- DIMM removal 89

- Disk Drives 51

- advanced PIO mode 54
- cylinder 53
- DMA transfer mode 54
- floppy drives A/B 51
- Hard disk 32-bit access 54
- Hard disk block mode 54
- Hard disk size > 504 MB 53
- head 53
- IDE primary channel master 51
- IDE primary channel slave 52
- IDE secondary channel master 52
- IDE secondary channel slave 52
- LS-120 drive as 51
- sector 53
- size 53
- type 53

- DMI 26

E

- entering Setup 44
- error messages 18
 - correcting 20
 - hardware 18
 - software 18
 - system 18

- ESD precautions 81

- exit Setup 77

- expansion slots 25

F

- FDD/hard disk support 33

- features 5

- front panel 5

- internal components 8

- rear panel 6

H

- Hardware Monitoring 37

I

- installation precautions 81

- post-installation 82

- preinstallation 81

- installing and removing add-on cards

- installing a PCI card 96

J

jumper settings 30

L

Load default settings 75

M

main menu 44

Memory at 15MB - 16MB reserved for 72

Memory Cache Options

cache scheme 71

external cache 71

internal cache 71

MIDI 3

modem ring-in 38

O

Onboard Device Settings 56

floppy disk controller 57

IDE controller 57

onboard audio chip 58

PS/2 mouse controller 57

USB host controller 57

USB legacy mode 58

Onboard Peripherals 55

base address 55, 56

ECP DMA channel 56

IRQ 55, 56

operation mode 56

parallel port 56

serial port 1/2 55

opening the system 83

removing cover 83

replacing cover 85

overview 3

P

Parallel Port 25

Password

bypassing 69

changing 68

removing 68

setting 67

PCI 3

Power Management 59

IDE hard disk timer 59

modem ring indicator 60

power management mode 59

power switch > 4 seconds 60

Sleep mode 60

system sleep timer 60

system wake-up event 60

power management 26

power on computer 14

preinstallation 4

Product Information 49

DMI BIOS version 50

main board ID 49

product name 49

system BIOS version 49

system serial number 49

R

replacing HDD 94

S

SDRAM 25

Software Shutdown 26

System Information 46

1st bank 48

2nd bank 48

external cache size 47

floppy drive A 47

floppy drive B 47

IDE primary channel master 47

IDE primary channel slave 47

IDE secondary channel master 47

IDE secondary slave 48

internal cache size 47

parallel port 48

processor 47

processor speed 47

PS/2 mouse 48

serial port 1 48

serial port 2 48

total memory 48

system introduction 3

system reconfiguration 89

System Security 65

disk drive control 66

floppy drive 66

hard disk drive 66

operation mode 66

Power-on password 66

Setup password 65

T

troubleshooting 16

turning off computer 15

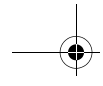

turning on computer 14

U

USB 3, 26, 36

V

video function 34

AGP 34

memory 34

shared-frame buffer 34

W

Wake-on LAN (WOL) 39

