



# Acer LCD TV

## AL2671W

### User's Guide





Copyright © 2005. Acer Incorporated.  
All Rights Reserved.

Acer LCD TV AL2671W User's Guide  
Original Issue: May 2005



Acer and the Acer logo are registered trademarks of Acer Incorporated. SRS WOW technology is incorporated under license from SRS Labs, Inc. Other company's product names or trademarks are used herein for identification purposes only and belong to their respective companies.



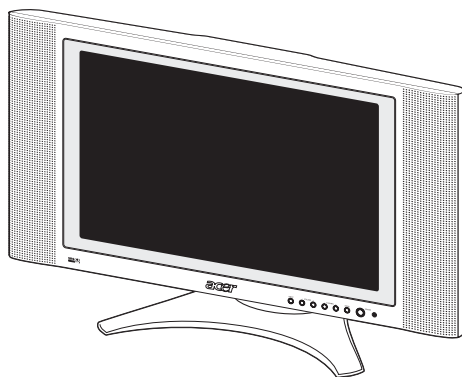

# Contents

<b>Important safety instructions</b>	<b>5</b>
Taking care of your remote control	6
Cleaning and servicing	6
<b>First things first</b>	<b>7</b>
Basic features and benefits	7
Packing Checklist	7
<b>Your LCD TV overview</b>	<b>8</b>
Front panel view	8
Rear panel view	9
Bottom view	9
<b>Remote control</b>	<b>10</b>
<b>Basic connection</b>	<b>12</b>
Connecting the power cord	12
Connecting an antenna	12
Connecting VCR/DVD/AV equipment with a SCART-SCART cable	13
Connecting VCR/DVD/AV equipment with a SCART-component/ AV cable	13
Connecting a camera, camcorder or video game	14
Connecting a headphone	14
<b>Getting started watching your TV</b>	<b>15</b>
Power On	15
Setup Wizard	15
Changing channels	15
Adjusting the volume	15
<b>OSD Navigation</b>	<b>16</b>
Navigating the OSD with Remote Control	16
<b>Teletext</b>	<b>17</b>
<b>Advanced Features</b>	<b>18</b>
PIP/PBP/POP	18
Parental Control	18
Empowering Key: Scenario Mode and Favorite Channels	19
<b>Troubleshooting</b>	<b>21</b>
<b>Product specifications</b>	<b>22</b>







# Important safety instructions

Read these instructions carefully. Save them for future reference.

- 1 Follow all warnings and instructions marked on the product.
- 2 Unplug this product from the wall outlet before cleaning. Do not use liquid cleaners or aerosol cleaners. Use a damp cloth for cleaning.
- 3 Do not use this product near water.

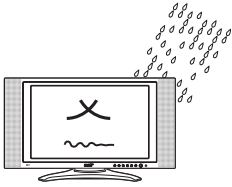

- 4 Do not place this product on an unstable cart, stand, or table. The product may fall, causing serious damage to the product.



- 5 Slots and openings are provided for ventilation; to ensure reliable operation of the product and to protect it from overheating. These openings must not be blocked or covered. The openings should never be blocked by placing the product on a bed, sofa, rug, or other similar surface. This product should never be placed near or over a radiator or heat register, or in a built-in installation unless proper ventilation is provided.

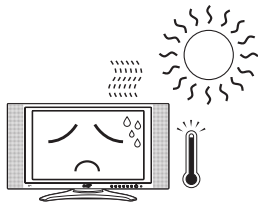

- 6 This product should be operated from the type of power indicated on the marking label. If you are not sure of the type of power available, consult your dealer or local power company.
- 7 Do not allow anything to rest on the power cord. Do not locate this product where persons will step on the cord.



- 8 If an extension cord is used with this product, make sure that the total ampere rating of the equipment plugged into the extension cord does not exceed the extension cord ampere rating. Also, make sure that the total rating of all products plugged into the wall outlet does not exceed the fuse rating.
- 9 Never push objects of any kind into this product through cabinet slots as they may touch dangerous voltage points or short out parts that could result in a fire or electric shock. Never spill liquid of any kind on the product.
- 10 Do not attempt to service this product yourself, as opening or removing covers may expose you to dangerous voltage points or other risks. Refer all servicing to qualified service personnel.
- 11 Unplug this product from the wall outlet and refer servicing to qualified service personnel under the following conditions:
  - a. When the power cord or plug is damaged or frayed.
  - b. If liquid has been spilled into the product.
  - c. If the product has been exposed to rain or water.
  - d. If the product does not operate normally when the operating instructions are followed. Adjust only those controls that are covered by the operating instructions since improper adjustment of other controls may result in damage and will often require extensive work by a qualified technician to restore the product to normal condition.
  - e. If the product has been dropped or the case has been damaged.
  - f. If the product exhibits a distinct change in performance, indicating a need for service.
- 12 Use only the proper type of power supply cord set (provided in your accessories box) for this unit. Always disconnect the power cord from the wall outlet before servicing or disassembling this equipment.

## Taking care of your remote control

Here are some ways to handle your remote control:

- Dropping, wetting or placing the remote control in the sunlight may cause damage. Handle the remote control with care.
- Do not tamper with batteries. Keep them away from children.
- When you anticipate that the remote control will not be used for an extended period, remove the batteries to prevent possible damage to the remote control in a result of battery leakage.
- Dispose of used batteries according to local regulations.  
Recycle if at all possible.

## Cleaning and servicing

When cleaning your LCD TV, follow these steps:

- 1 Power off the TV.
- 2 Disconnect the power cord.
- 3 Use a soft cloth moistened with water. Do not use liquid or aerosol cleaners.



# First things first

We would like to thank you for making the Acer AL2671W your choice. Your new Acer TV will provide you with years of entertainment, versatility, and satisfaction.

This User's guide introduces you to the various features your LCD TV can offer, and provides clear and concise information about the product, so please read it thoroughly and retain it for future reference.

## Basic features and benefits

- Wide Display with 1280x768 Resolution - HDTV Ready Display
- Simultaneous Pre-Viewing of Programs with 4 different Picture-In-Picture Modes
- Excellent Sound Enhancement with SRS WOW Technology
- Elegant Remote Control
- Brilliant Color with Gamma Correction
- Minimized Motion Artefacts thru Noise Reduction
- Sharp and Accurate Image with De-interlacing and Comb Filter
- Best DVD Video Quality with 3:2/2:2 Pull Down Recovery

## Packing Checklist

Your LCD TV package should contain the following accessories, in addition to the accessory box. Please ensure that they are all present.

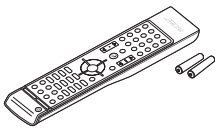

Remote Control (X1)  
AAA Batteries (X2)

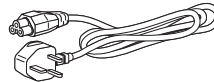

Power cord-UK (X1)

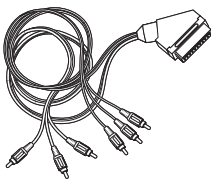

SCART-Component/  
AV Cable (X1)  
(Component for SCART 2 only)



Warranty Card

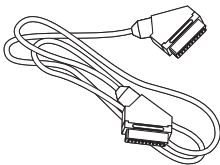

SCART-SCART Cable (X1)  
(for SCART 1 & 2)

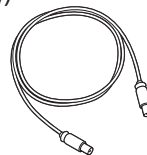

TV cable (X1)

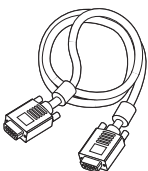

D-Sub cable (X1)



Quick Guide



User Manual

# Your LCD TV overview

## Front panel view

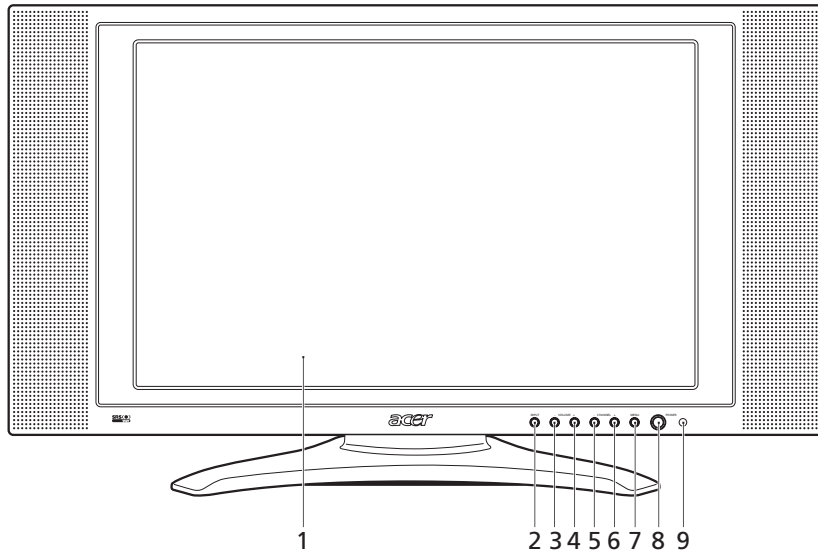

#	Item	Description
1	LCD Screen	
2	Input	Select source. When OSD is on: Press this button to confirm selection
3	Vol Down	Volume Down. When OSD is on: Also functions the same as Left directional arrow
4	Vol Up	Volume Up. When OSD is on: Also functions the same as Right directional arrow
5	Channel Down	Channel Down. When OSD is on: Also functions the same as Down directional arrow
6	Channel Up	Channel Up. When OSD is on: Also functions the same as Up directional arrow
7	Menu	Turn OSD menu ON/OFF
8	Power	Power ON/OFF
9	Remote Control Window	Infrared Sensor (Do not block)





## Rear panel view

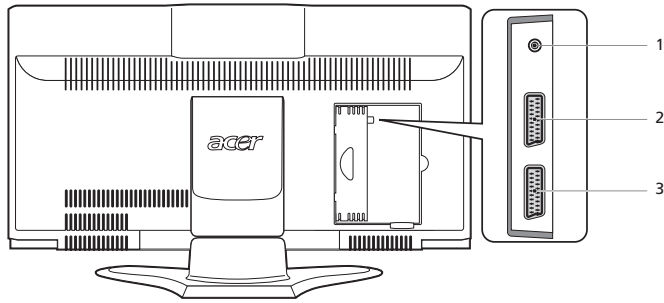

#	Item	Description
1	RF Connector (TV Tuner) Input	Connects to the antenna or cable service
2	AV1/SCART 1 In  AV1/SCART 1 Out	Supports external VCR, DVD player with the SCART cable (for RGB, S-Video, CVBS, Audio left/right input) In TV mode, connect your VCR In or PVR In with the SCART cable to record TV programs
3	AV2/SCART 2 In  AV2/SCART 2 Out	Supports external VCR, DVD player with the SCART cable (for RGB, S-Video, CVBS, YPbPr/YCbCr, Audio left/right input) Component (YPbPr/YCbCr) for SCART 2 only In TV mode, connect your VCR In or PVR In with the SCART cable to record TV programs

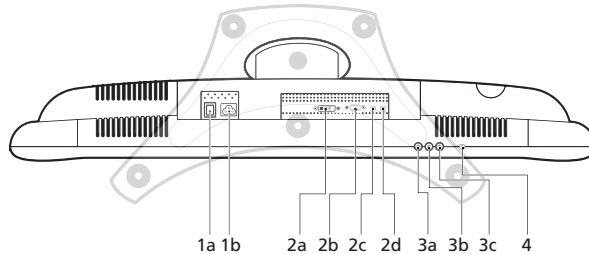

## Bottom view

#	Item	Description
1a	AC Switch	Turns AC In power ON/OFF
1b	AC In	Connects to a power source
2a	DVI-D In	Connects to PC DVI Out
2b	D-Sub In	Connects to PC VGA Out
2c	Audio In	In PC mode, connect to audio output of your PC or other devices with DVI or VGA connector
2d	Audio Out	Connects to another speaker
3a/b	AV3/Audio In (R/L)  AV3/Audio Out (R/L)	Connect to the audio output(R/L) of your camera, camcorder or video game In TV mode, connect the audio(R/L) input of your VCR or PVR to record TV programs (Please set AV3 to "Out" in OSD)
3c	AV3/Video In  AV3/Video Out	Connect the composite output of your camera, camcorder or video game In TV mode, connect the composite input of your VCR or PVR to record TV programs (Please set AV3 to "Out" in OSD)
4	Headphone	Connect headphone



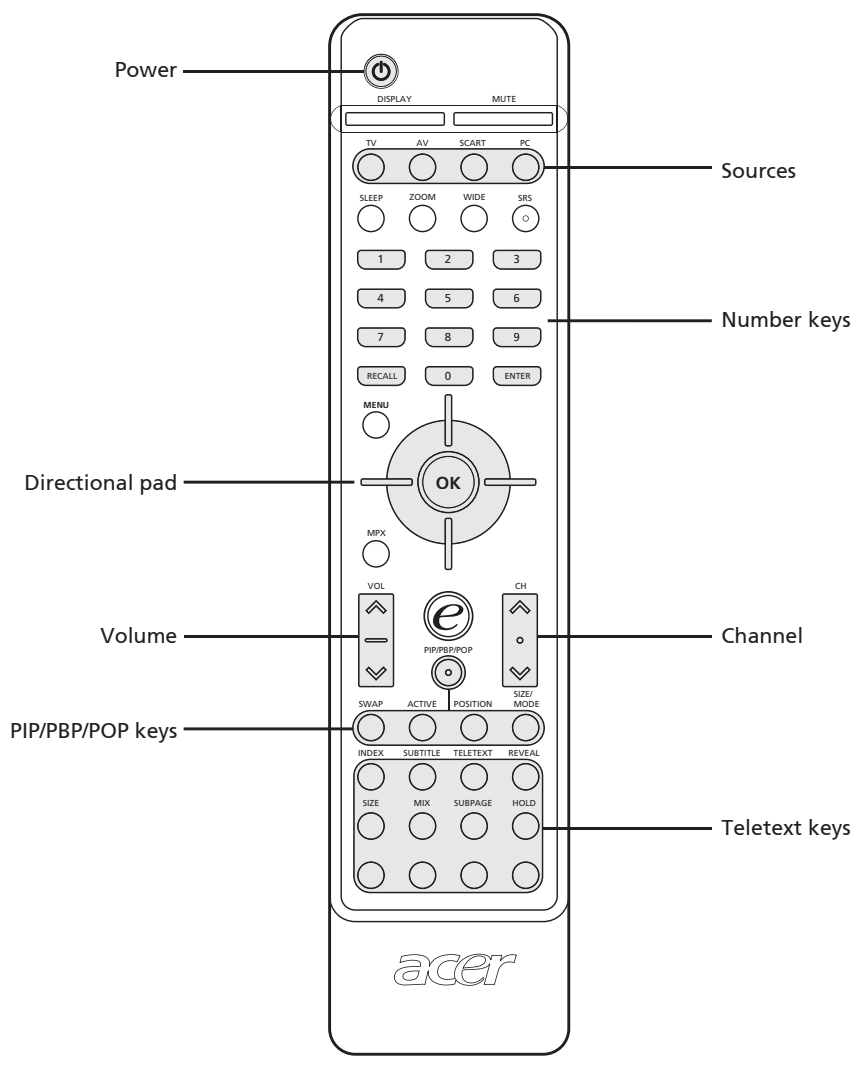

# Remote control

English





Item	Description
Power button	Press to turn TV on/off.
DISPLAY	Displays channel number and input source on the upper right-hand corner of the screen.
MUTE	Press once to mute the sound; press again to restore.
TV	Press to select TV mode.
AV	Press to select AV3 mode.
SCART	Press to select SCART1/SCART2 mode.
PC	Press once for VGA mode, press twice for DVI.
SLEEP	Press to set a time period after which the TV should switch itself to standby. Press repeatedly to select the number of minutes.
ZOOM	Press repeatedly to switch image between Normal  Zoom1 (1.85:1)  Zoom 2 (2.35:1) 
SRS	Press to select WOW, TruBass, 3D Stereo, "Off" modes sequentially. SRS is a technology to enhance 3D sound, bass performance and to produce a wider sound field.
WIDE	Scaling mode (4:3 / 16:9 / Panorama / Letterbox)
Number keys	Number keys from 0-9
RECALL	Press to return to the previous channel.
ENTER	Press to confirm channel selections by the number keys.
MENU	Open Menu or leave Menu.
4-way scroll key/OK	Navigate up, down, left and right in the OSD menu / press OK to confirm.
MPX	Press to select the sound system, displayed at the top right-hand corner.
VOL (up/down)	Press these buttons to increase and decrease the volume.
CH (up/down)	Press these buttons to select the TV channel in sequence
e	Acer Empowering key (for Favorite Channel, Scenario Mode). See "Empowering Key: Favorite Channels and Scenario Mode" on page 19.
PIP/PBP/POP	Switch between Normal/PIP/PBP/POP modes. See "Advanced Features" on page 18.
SWAP	Swap primary and sub screen in toggle.
ACTIVE	Toggle the active screen.
POSITION	Change position of subscreen in PIP mode
SIZE/MODE	When in PIP mode: Change subscreen size 25%, 37.5%, 50% When in POP mode: Change POP mode 1+5 / 1+12



The teletext button descriptions can be found on page 17.





# Basic connection

English

## Connecting the power cord

- 1 Connect the AC cord into the AC input on the back of the set.
- 2 Connect the male plug to the wall outlet as shown.

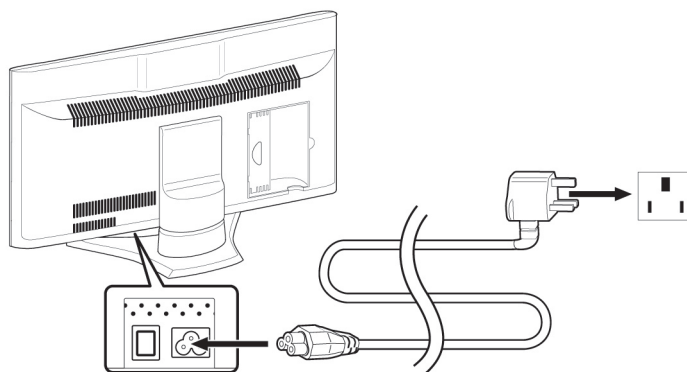

## Connecting an antenna

Connect the outdoor antenna cable lead-in to the antenna terminal on the back of the TV set as shown.

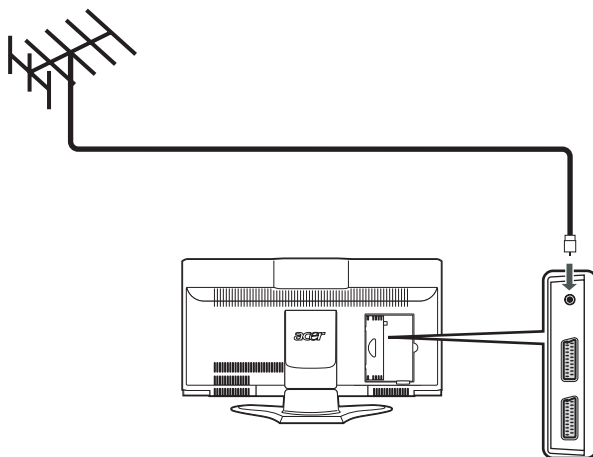



## Connecting VCR/DVD/AV equipment with a SCART-SCART cable

Connect SCART-SCART cable as shown below.

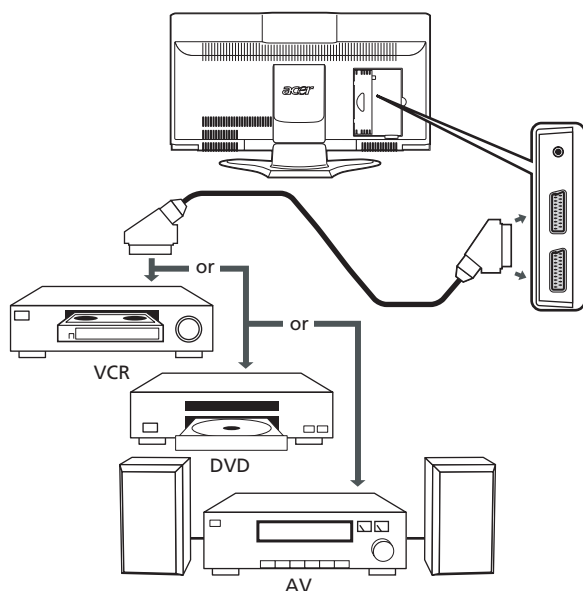

## Connecting VCR/DVD/AV equipment with a SCART-component/AV cable

Connect SCART-component/AV cable to SCART2 port as shown below.

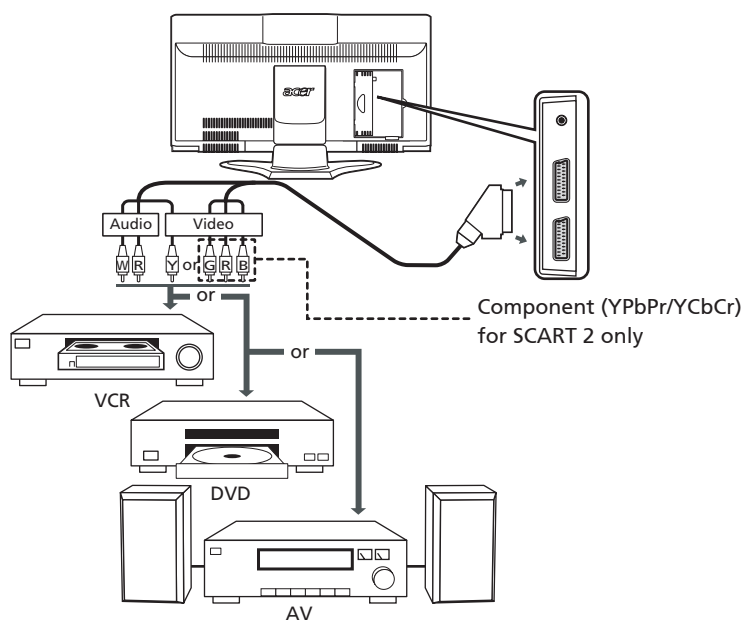



## Connecting a camera, camcorder or video game

Connect your camera or camcorder to the Video/Audio ports on the bottom of the TV set as shown below.

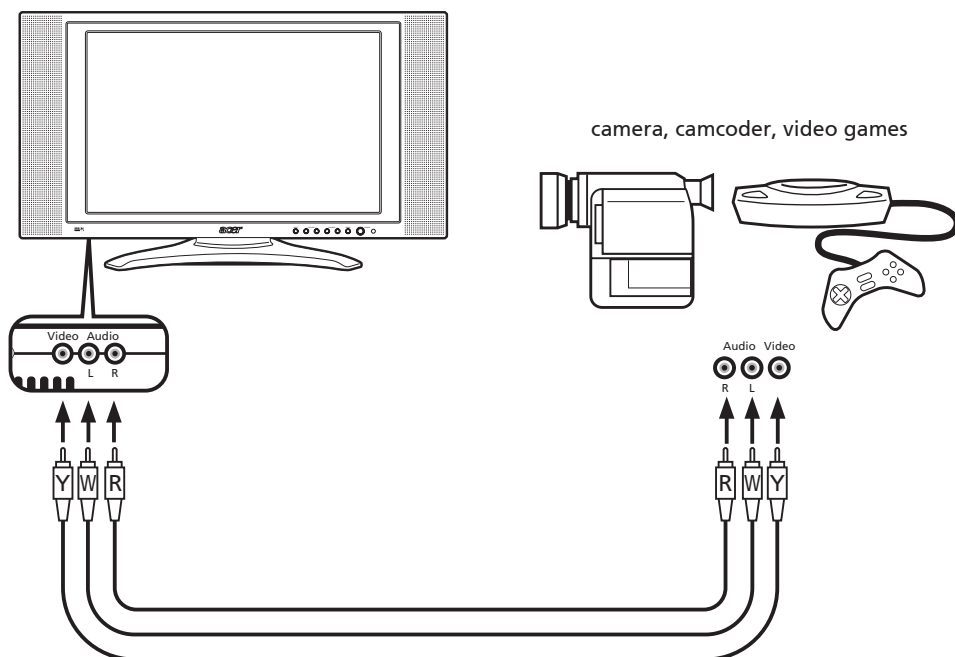

## Connecting a headphone

Connect headphone to the headphone input on the bottom of the TV set as shown below.

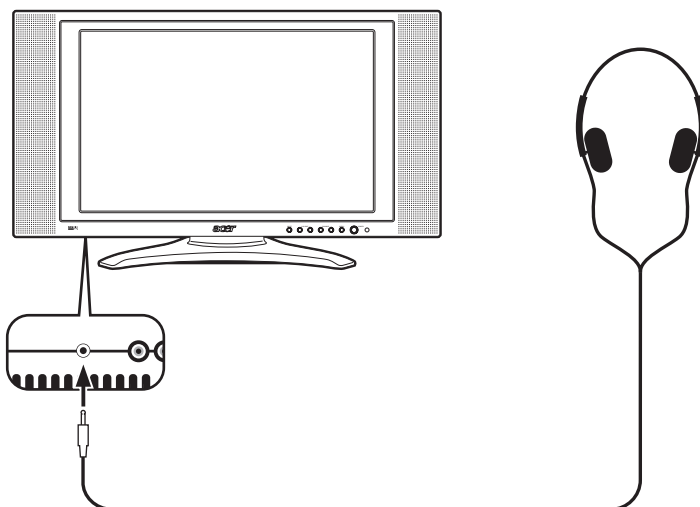



# Getting started watching your TV

## Power On

- Turn on power switch on bottom of TV.
- Press the power button, number keys or channel up/down button on remote control

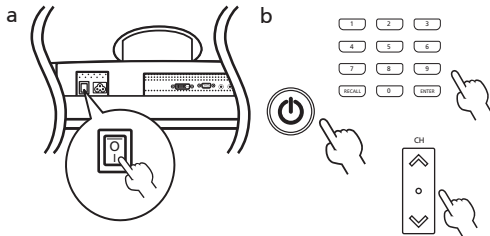

## Changing channels

- Press 0-9 on the remote control to select a channel. The channel changes after 2 seconds. Press ENTER to select the channel immediately.

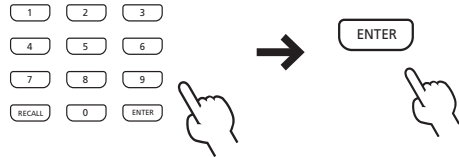

- You can also change the channels by pressing and holding the Channel Up/Down button on the remote control. Up will increase the number, while down will decrease the number.

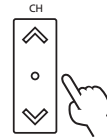

## Setup Wizard

The first time you power on the TV, the setup wizard will guide you to complete the "language selection" and "channel scanning" setup by step.

Step 1. Please plug in the tuner coaxial cable and then press "OK" key

Step 2. Auto Scanning, please wait

Setup completed

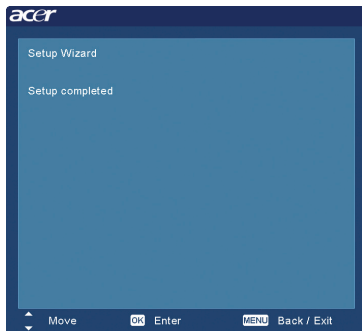

## Adjusting the volume

Adjust the volume using the VOL +/- button on the remote control. Up will increase the volume, while down will decrease the volume.



You can also adjust these settings using the front control panel. Please see "Front panel view" on page 8 for details.



# OSD Navigation

Many of the advanced settings and adjustments are available through using the OSD (on screen display) menus, as shown in the example screenshot below.

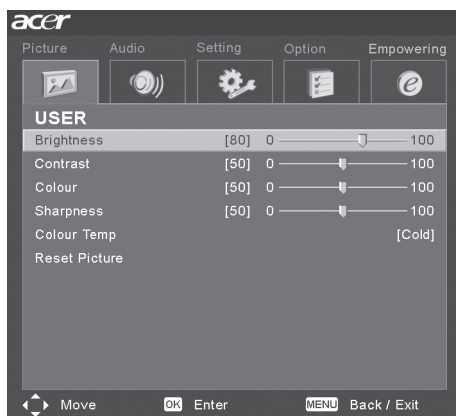



Basic operations required to navigate these menus (Picture, Audio, Settings, Options, Empowering) are described in this section. The first time you access the OSD, you will be asked to choose your language settings.



You can also interact with these menus using the front panel controls. Please see "Front panel view" on page 8 for details.

## Navigating the OSD with Remote Control

There are five main OSD menus. These are: Picture , Audio , Settings , Options  and Empowering . Use the following method to easily navigate these menus.

- 1 Press the "Menu" button on the remote control or the "Menu" button on the control panel.

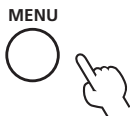

- 2 Select your desired menu by using the Left/Right sides of the directional pad to switch between the five menus.

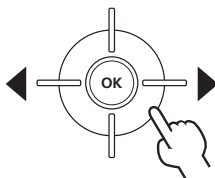

- 3 Use the directional pad to interact with the menu. The Up/Down directions will scroll through the menu options, while Left/Right will adjust the different settings (for example, in the Picture menu, settings such as brightness, contrast, etc). If there are no adjustments, press Enter to select.





# Teletext

Most TV channels also broadcast information via the teletext feature. This Acer LCD TV has 252 pages of memory which will store pages and subpages, thereby reducing waiting time. The teletext buttons on the remote control are listed below.

Item	Description
INDEX	Go to index page
SUBTITLE	Show subtitle on the screen
TELETEXT	Press to switch from TV/AV to Teletext mode.
REVEAL	Press to reveal hidden teletext information.
SIZE	Press once to zoom teletext page to 2X; press again to resume.
MIX	Press to overlay teletext page on the TV image, i.e. subtitle.
HOLD	Press to pause the current teletext page in multi-page viewing mode.
Color buttons (R/G/Y/B)	Operates corresponding button on the teletext page.



# Advanced Features

English

## PIP/PBP/POP

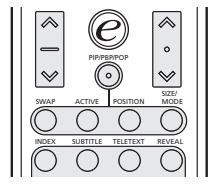

In TV, AV, SCART and PC mode, press PIP/PBP/POP button once to display the picture in picture (PIP). Press twice to display picture by picture (PBP).

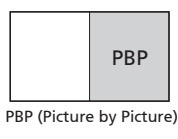
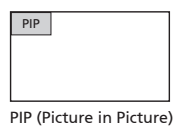

In SCART(YPbPr/YCbCr) and PC(VGA, DVI) mode, press PIP/PBP/POP button three times to display picture on picture (POP). Then, the POP screens will display the TV channel programs one by one.

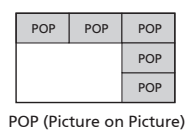

## PIP

1. Press the "TV/SCART/AV/PC" keys, number keys or "CH up/down" key to change the content of the PIP screen.
2. Press "Swap" key to change the content between the primary and the PIP screen.

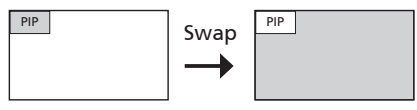

3. Press "Position" key to select the location of the subscreens, from Upper Left -> Upper Right -> Lower Right -> Lower Left, as shown in the image.

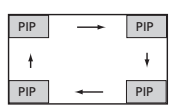

4. Press the "Size/Mode" key to change the size of the PIP screen between 25%, 37.5%, 50%

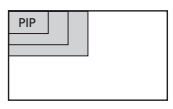

## PBP

1. Press the "TV/SCART/AV/PC" keys, number keys or "CH up/down" key to change the content of the PBP screen.
2. Press "Swap" key to change the content between the primary and the PBP screen.

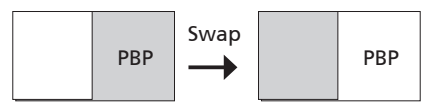

## POP

1. Press "Activate" key to activate the TV channel on the top-left POP screen.
2. Press the number keys or "CH up/down" key to change the TV channel of the top-left POP screen. Then, press the "activate" key again. The other POP screens will show the following channels in sequence.
3. Press the "Size/Mode" key to access the 1 + 5 or 1+12 picture on picture mode as shown in the image below.

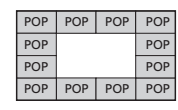
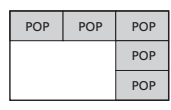

## Parental Control

When in TV mode, you can find a Parental Control feature in the Options  menu. Enter a four-digit PIN number using the number keys on your remote control. Use this number to adjust the Parental Control settings, to prevent access to certain channels.

If you forget your PIN number, please enter 6163 to reset.

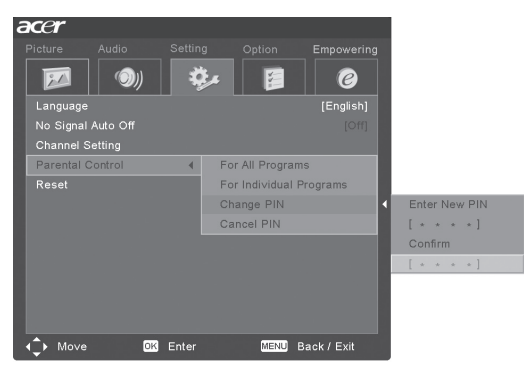



# Empowering Key: Scenario Mode and Favorite Channels



English

Use the OSD to define your “e” Empowering key setting: Scenario mode and Favorite channel. The default value for the “e” key is the Scenario mode. Use the following method: Menu -> Empowering -> e Key Setting. Choose between “Favorite channel” or “Scenario Mode”. Now, when you press the “e” key, your chosen selection will be accessed.

## Scenario Mode

Press the “e” Empowering key and use the Scenario Mode to select pre-defined audio and video settings for optimal enjoyment of the following scenarios: Standard, Movie, Sport, Concert, Game, User.

Mode	Scenario Mode Design Direction
Standard	Standard mode allows you to watch your favourite channels with sharp, brilliant imagery via adaptive brightness and contrast adjustments. Clear-sounding audio is provided by 3D Stereo performance.
Movie	For comfortably enjoying movies at home, Movie mode displays dim scenes in clear detail; compensates for colour; and smoothly presents motion images. This is accomplished through optimal Gamma correction plus saturation, brightness and contrast adjustments. Movie mode makes the most of high-definition movie soundtracks by using SRS WOW technology.
Game	Game mode carefully details the exquisite graphics of modern video games, providing lifelike entertainment while protecting your eyesight by adjusting brightness and contrast. What’s more, Game mode provides a heightened audio experience via SRS WOW technology.
Sports	Sports mode is suited for outdoor sports programmes, with accurate background depth and clear gradation between the bright, outdoor playing field and darker auditoriums. Sports mode also brilliantly enhances colours and presents swiftly moving pictures without residual images. All of this is achieved via specific Gamma corrections and saturation adjustments. Precise audio can be heard, thanks to Tru-Bass performance.
Concert	Concert mode places you in a virtual concert hall, opera house or other dim environment by means of adaptive brightness and contrast adjustments. Concert mode accentuates symphonic harmonies and the tenor audio range using SRS WOW technology.

## Favorite Channels

Please note that Scenario mode is the default value for the "e" Empowering key. In order to make use of the following instructions, please set Favorite channel as the default using the method described on the previous page.

### Storing favorite channels

For quick access to your favorite channels, use the following method:

- To store a channel in memory for quick access, select your desired channel, then press and hold the "e" Empowering key on the remote control for more than 2 seconds. This will store the TV program information at the bottom of the favorite list.
- There are a total of five slots in which you can store TV programs.
- If there is no empty slot in the favorite list, the first program will be wiped out and the new TV program is added at the bottom of the favorite list. Simply put, it's "First in, first out".
- When the current program is stored in the favorite list, pressing the "e" key for more than 2 seconds will remove the program from the favorite list.
- To view currently stored favorite channels, press the "e" Empowering key. You will see a screen similar to the one shown below.



### Viewing your favorite channels

- On the remote control, if you press the "e" Empowering key for less than 1 second, the favorite channel table will pop up. Your currently selected favorite channel will be highlighted. To view your other favorite channels, press the "e" Empowering key again to toggle the TV programs sequentially according to your favorite list.



# Troubleshooting

Before you call the Acer service center, please check the following items:

The following is a list of possible situations that may arise during the use of your LCD TV. Easy answers and solutions are provided for each one.

## There is no picture or sound.

- Make sure the power cord is properly inserted in the power outlet.
- Make sure the input mode is correctly set by your selected input.
- Make sure the antenna at the rear of the TV is properly connected.
- Make sure the main power switch is turned on.
- Make sure the volume is not set to minimum or the sound is not set to mute.
- Make sure the headphones are not connected.
- Reception other than those of broadcasting stations can be considered.

## Picture is not clear.

- Make sure the antenna cable is properly connected.
- Consider whether TV signals are being properly received.
- Poor picture quality can occur due to A-VHS camera or camcorder and other peripheral connections at the same time. Switch off one of the other peripheral.
- The 'ghost' or double image may be caused by obstruction to the antenna due to high rise buildings or hills. Using a highly directional antenna may improve the picture quality.
- The horizontal dotted lines shown on the pictures may be caused by electrical interference, e.g. hair dryer, nearby neon lights and etc. Turn off or remove these equipment.

## Picture is too dark, too light or tinted.

- Check the color adjustment.
- Check the brightness setting.
- Check the sharpness function.
- Fluorescent lamp may have reached the end of service life.

## Remote control does not work.

- Check the batteries of the remote control.
- Make sure the remote sensor window is not under strong fluorescent lighting.
- Try to clean the remote control sensor lens on the TV with a soft cloth.
- Use the buttons (hot keys) on the TV before the remote control works.

If the above items do not solve your technical issue, please refer to the warranty card for service information.

# Product specifications

	Item	Specification
Panel spec	Resolution	1280 x 768
Mechanical	Dimensions(WxHxD mm)	828 x 484 x 248
	Swivel angle	-20~+20
	Weight (kg)/(lb)	14/30
	Wall mounting	Yes (mounting kit not included)
TV system	Destination	Europe
	Color system	PAL/SECAM
	Sound system	B/G/D/K/I/L
	Stereo system	NICAM/FM stereo (A2)
Terminal	Destination	Europe
	AV1/SCART1	SCART (CVBS,RGB,S-Video,Audio R/L)
	AV2/SCART2	SCART (CVBS,RGB,S-Video,YPbPr/YCbCr,Audio R/L)
	AV3	CVBS,Audio R/L
	PC D-sub	YES
	DVI-D(HDCP)	YES
	PC audio in	YES
Audio system	3D surround	YES
	Speaker	5W+5W
	SRS	WOW, TruBass, 3D Stereo
Power supply	Max. power consumption	150W