

# Acer PDP TV

## AT4202P User's Guide

## Contents

|  |           |
|--|-----------|
| <b>Important safety instructions</b>                     | <b>3</b>  |
| Disposal instructions                                    | 4         |
| <b>First things first</b>                                | <b>5</b>  |
| Basic features and benefits of your Acer PDP TV          | 5         |
| Packing checklist  | 5         |
| <b>Your PDP TV overview</b>                              | <b>6</b>  |
| Front panel view   | 6         |
| Rear panel view  | 7         |
| Bottom panel view  | 7         |
| <b>Remote control</b>                                    | <b>8</b>  |
| General keys   | 8         |
| Teletext   | 9         |
| <b>Basic connections</b>                                 | <b>10</b> |
| Connecting the power cord                                | 10        |
| Setting up the remote control                            | 10        |
| <b>Enjoying analog TV</b>                                | <b>11</b> |
| Connecting an antenna/cable                              | 11        |
| Getting started watching your TV                         | 11        |
| <b>Connecting external audio/video devices</b>           | <b>14</b> |
| Connecting a DVD, VCR, STB or audio/video equipment      | 14        |
| Connecting a camera, camcorder, video game or headphones | 15        |
| Connecting a PC or notebook computer                     | 15        |
| Selecting the input source                               | 15        |
| <b>OSD navigation</b>                                    | <b>16</b> |
| Navigating the OSD with the remote control               | 16        |
| Adjusting the OSD settings                               | 17        |
| <b>Empowering Technology</b>                             | <b>18</b> |
| Set-up Empowering mode                                   | 18        |
| Default setting in different Empowering mode             | 19        |
| <b>Advanced features</b>                                 | <b>20</b> |
| PIP  | 20        |
| Audio effects  | 20        |
| Lock TV  | 21        |
| Re-scan for channels                                     | 23        |
| Widescreen display mode                                  | 24        |
| <b>Dimensions</b>  | <b>25</b> |
| AT4202P  | 25        |
| <b>Appendix-Source Options</b>                           | <b>26</b> |
| PIP  | 26        |
| <b>Troubleshooting</b>                                   | <b>27</b> |
| <b>Product specifications</b>                            | <b>28</b> |



Copyright © 2006. Acer Incorporated.  
All Rights Reserved.

Acer PDP TV User's Guide  
Original Issue: 04/2006

Changes may be made periodically to the information in this publication without obligation to notify any person of such revisions or changes. Such changes will be incorporated in new editions of this manual or supplementary documents and publications. This company makes no representations or warranties, either expressed or implied, with respect to the contents hereof and specifically disclaims the implied warranties of merchantability or fitness for a particular purpose.

Record the model number, serial number, purchase date, and place of purchase information in the space provided below. The serial number and model number are indicated on the label affixed to your device. All correspondence concerning your unit should include the serial number, model number, and purchase information.

No part of this publication may be reproduced, stored in a retrieval system, or transmitted, in any form or by any means, electronically, mechanically, by photocopy, recording, or otherwise, without the prior written permission of Acer Incorporated.

Model Number: \_\_\_\_\_

Serial Number: \_\_\_\_\_

Purchase Date: \_\_\_\_\_

Place of Purchase: \_\_\_\_\_

Acer and the Acer Logo are registered trademarks of Acer Inc. Other companies' product names or trademarks are used herein for identification purposes only and belong to their respective companies.



WOW, SRS &  are trademarks of SRS Labs, Inc. WOW technology is incorporated under license from SRS Labs, Inc.



# Important safety instructions

Read these instructions carefully. Please put them somewhere safe for future reference.

- 1 Follow all warnings and instructions marked on the product.
- 2 Unplug this product from the wall outlet before cleaning. Do not use liquid cleaners or aerosol cleaners. Use a damp cloth for cleaning.
- 3 Do not use this product near water.

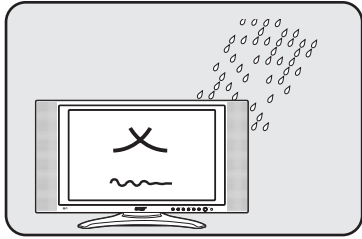

- 4 Do not place this product on an unstable cart, stand or table. The product may fall, sustaining serious damage.

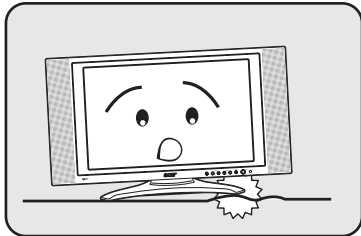

- 5 Slots and openings are provided for ventilation; to ensure reliable operation of the product and to protect it from overheating, these openings must not be blocked or covered. The openings should never be blocked by placing the product on a bed, sofa, rug or other similar surface. This product should never be placed near or over a radiator or heat register or in a built-in installation unless proper ventilation is provided.

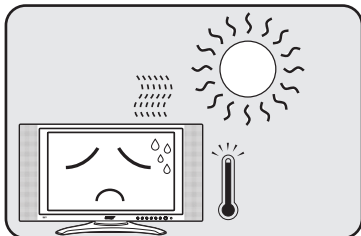

- 6 This product should be operated from the type of power indicated on the marking label. If you are not sure of the type of power available, consult your dealer or local power company.
- 7 Do not allow anything to rest on the power cord. Do not locate this product where the cord will be stepped on.

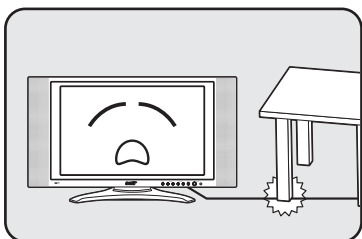

- 8 If an extension cord is used with this product, make sure that the total ampere rating of the equipment plugged into the extension cord does not exceed the extension cord ampere rating. Also, make sure that the total rating of all products plugged into the wall outlet does not exceed the fuse rating.
- 9 Never push objects of any kind into this product through cabinet slots as they may touch dangerous voltage points or short-out parts, which could result in a fire or electric shock. Never spill liquid of any kind on the product.
- 10 Do not attempt to service this product yourself, as opening or removing covers may expose you to dangerous voltage points or other risks. Refer all servicing to qualified service personnel.
- 11 Unplug this product from the wall outlet and refer servicing to qualified service personnel under the following conditions:
  - a. When the power cord or plug is damaged or frayed.
  - b. If liquid has been spilled into the product.
  - c. If the product has been exposed to rain or water.
  - d. If the product does not operate normally when the operating instructions are followed. Adjust only those controls that are covered by the operating instructions. Improper adjustment of other controls could result in damage; extensive work by a qualified technician might then be required to restore the product to normal condition.
  - e. If the product has been dropped or the case has been damaged.
  - f. If the product exhibits a distinct change in performance, indicating a need for service.
- 12 Use only the proper type of power supply cord set (provided in your accessories box) for this unit. Always disconnect the power cord from the wall outlet before servicing or disassembling this equipment.
13. Do not overload an electrical AC outlet, power strip, or convenience receptical. The overall system load must not exceed 80% of the branch circuit rating. If power strips are used, the load should not exceed 80% of the power strip input rating.
- 14 Some products are equipped with a three-wire electrical grounding-type plug that has a third pin for grounding. This plug only fits into a grounded electrical outlet. This is a safety feature. Make sure the AC outlet is properly grounded. Do not defeat the safety purpose of the grounding-type plug by trying to insert it into a non-grounded outlet. If you cannot insert the plug into the outlet, contact your electrician to replace the obsolete outlet.



-----  
 The grounding pin is an important safety feature. It is possible to receive an electric shock from a system that is not properly grounded



-----  
 The grounding pin is also providing good immunity ability against unexpected noise that interferes performance of this product and is produced by other nearby electrical devices.

## Disposal instructions

Do not throw this electronic device into the rubbish bin / container when discarding. To minimize pollution and ensure utmost protection of the global environment, please recycle.

For more information regarding WEEE, please refer to <http://global.acer.com/about/environmental.htm>

### USA

For electronic products containing a PDP/CRT monitor or display:

Lamp(s) inside this product contain mercury and must be recycled or disposed of according to local, state or federal laws. For more information, contact the Electronic Industries Alliance at [www.eiae.org](http://www.eiae.org). For lamp-specific disposal information, check [www.lamprecycle.org](http://www.lamprecycle.org).

### FCC Notice

This device complies with Part 15 of the FCC Rules. Operation is subject to the following two conditions: (1) this device may not cause harmful interference, and (2) this device must accept any interference received, including interference that may cause undesired operation.

However, there is no guarantee that interference will not occur in a particular installation. If this device does cause harmful interference to radio or television reception, which can be determined by turning the device off and on, the user is encouraged to try to correct the interference by one or more of the following measures:

- Reorient or relocate the receiving antenna.
- Increase the separation between the device and receiver.
- Connect the device into an outlet on a circuit different from that to which the receiver is connected.
- Consult the dealer or an experienced radio/television technician for help.

### Notice: Shielded cables

All connections to other computing devices must be made using shielded cables to maintain compliance with FCC regulations.

### Notice: Peripheral devices

Only peripherals (input/output devices, terminals, printers, etc.) certified to comply with the Class B limits may be attached to this equipment. Operation with non-certified peripherals is likely to result in interference to radio and TV reception.

### Caution

Changes or modifications not expressly approved by the manufacturer could void the user's authority, which is granted by the Federal Communications Commission, to operate this computer.

### Operation conditions

This device complies with Part 15 of the FCC Rules. Operation is subject to the following two conditions: (1) this device may not cause harmful interference, and (2) this device must accept any interference received, including interference that may cause undesired operation.

### Notice: Canadian users

This Class B digital apparatus complies with Canadian ICES-003.

Remarque à l'intention des utilisateurs canadiens

Cet appareil numérique de la classe B est conforme à la norme NMB-003 du Canada.

### European Union (EU)

**This device complies with the essential requirements of the European Council:**

**The EMC Directive 89/336/EEC as attested by conformity with the following harmonized standards:**

EN55013: 2001+A1: 2003: Sound and television broadcast receivers and associated equipment - Radio disturbance characteristics - Limits and methods of measurement.

EN55020: 2002+A1: 2003: Sound and television broadcast receivers and associated equipment - Immunity characteristics - Limits and methods of measurement.

EN55022:1998/A1:2000; AS/NZS CISPR 22: 2002: Limits and methods of measurement of Radio Interference characteristics of Information Technology Equipment.

EN55024: 1998/A1: 2001; AS/NZS CISPR 24: 1997: Information technology equipment-Immunity characteristics - Limits and methods of measurement.

**The Low Voltage Directive 73/23/EEC as attested by conformity with the following harmonized standard:**

EN60065: 1998: Audio, video and similar electronic apparatus-safety requirements.

EN60950: 2000 3rd: Safety of Information Technology Equipment Including electrical business equipment.

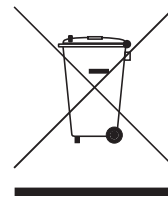

Compliant with Russian regulatory certification



ME61

## First things first

We would like to thank you for making the Acer PDP TV your choice. With proper care, your new Acer PDP TV will provide you with years of entertainment and satisfaction.

This User's Guide introduces you to the various features your PDP TV can offer, and provides clear and concise information about the product, so please read it thoroughly and retain it for future reference.

## Basic features and benefits of your Acer PDP TV

- Widescreen display with 1024 x 768 resolution
- Picture-in-picture mode for simultaneous previewing of programmes
- Remote control for ultimate convenience
- Gamma Correction for brilliant colour
- 3D motion-adaptive de-interlacing for exquisite details up to 1080i
- DCR<sup>e</sup>™ and 3D comb filtering for sharp and accurate images
- Acer Empowering Technology for selecting and defining personalized user preferences

## Packing checklist

Your PDP TV package should contain the following accessories, in addition to the accessory box. Please ensure that they are all present. If any of the items is missing, then please contact your retailer.

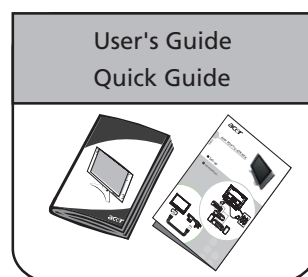
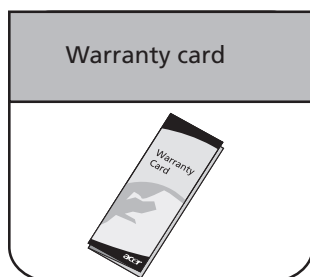
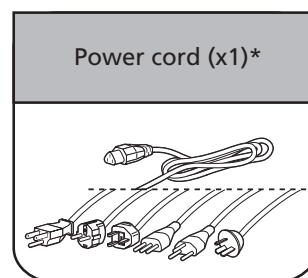
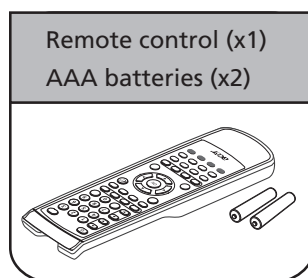
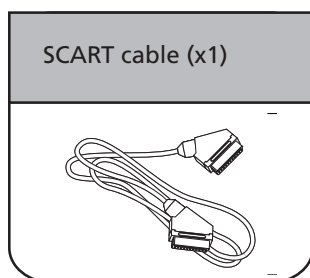

\* The power cord supplied varies according to your region.



# Your PDP TV overview

AT4202P

## Front panel view

|   |                 |
|---|-----------------|
| 1 | Channel up/down |
| 2 | Volume up/down  |
| 3 | Menu key        |
| 4 | Input key       |
| 5 | Power ON/OFF    |

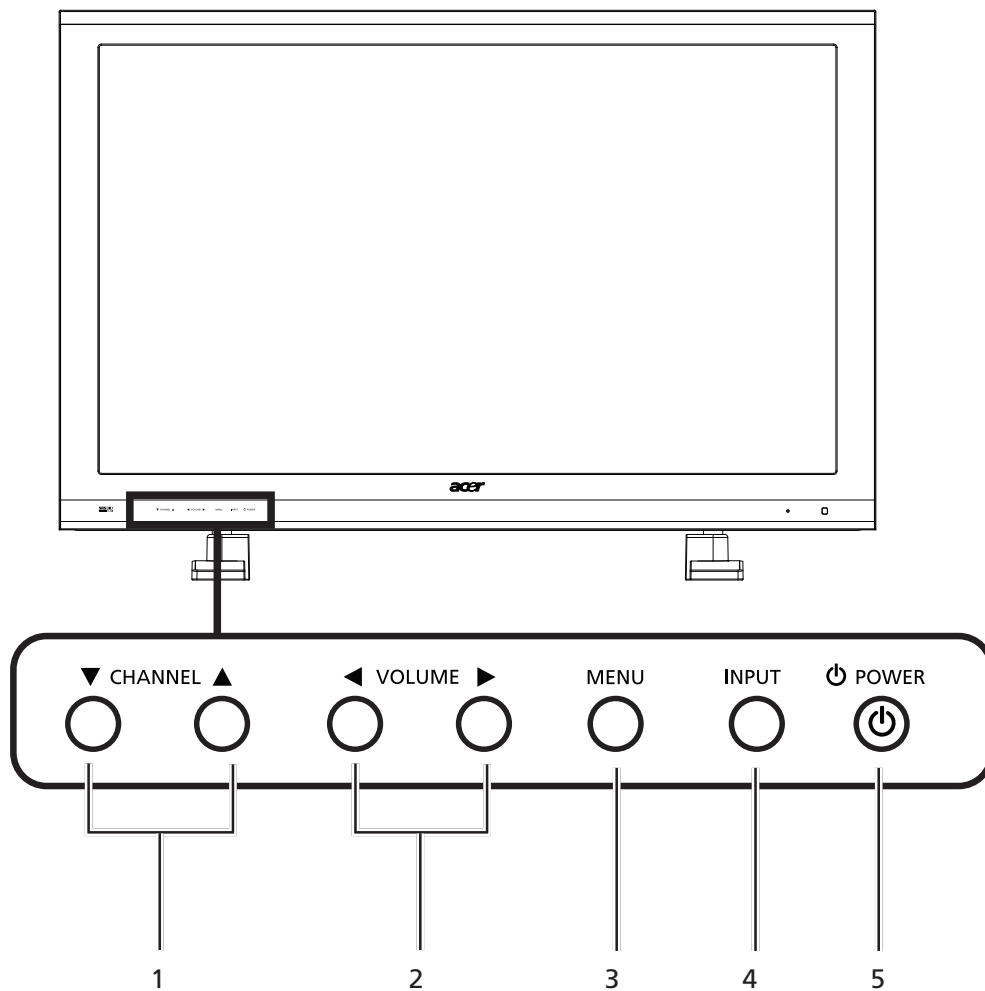

|   |  |              |  |
|---|--|--------------|--|
| 1 |  | Channel up   | When the OSD is on, functions the same as the Up arrow     |
|   |  | Channel down | When the OSD is on, functions the same as the Down arrow   |
| 2 |  | Volume up    | When the OSD is on, functions the same as the Right arrow  |
|   |  | Volume down  | When the OSD is on, functions the same as the Left arrow   |
| 3 |  | Menu key     | Turns the OSD menu ON and OFF                              |
| 4 |  | Input key    | When the OSD is on, press this button to confirm selection |





| Rear panel view |                              |
|-----------------|------------------------------|
| 1               | Power switch                 |
| 2               | AC-in                        |
| 3               | External speakers (optional) |
| 4               | S-VIDEO                      |
| 5               | CVBS-VIDEO                   |
| 6               | AUDIO L/R                    |
| 7               | EARPHONE                     |

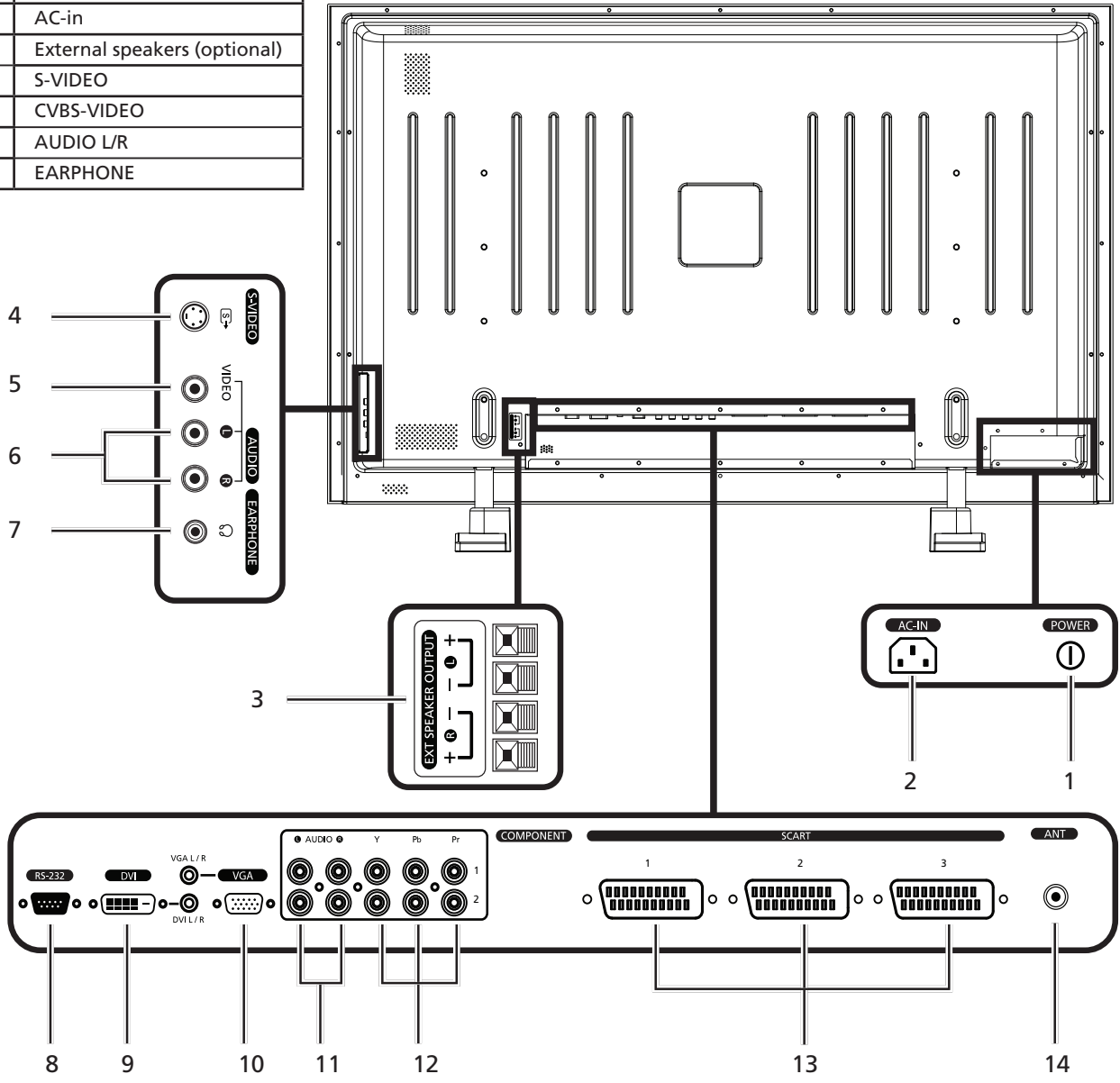

| Bottom panel view |                             |
|-------------------|-----------------------------|
| 8                 | RS-232                      |
| 9                 | DVI-D + Audio               |
| 10                | VGA + Audio                 |
| 11/12             | AUDIO (L/R) / COMPONENT x 2 |
| 13                | SCART x 3                   |
| 14                | Analog antenna              |

## Remote control

### General keys

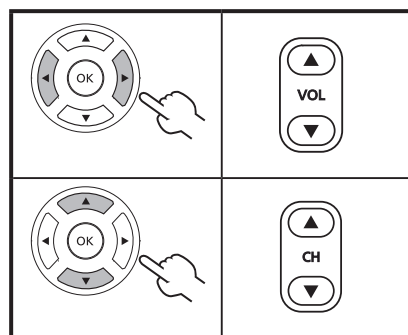
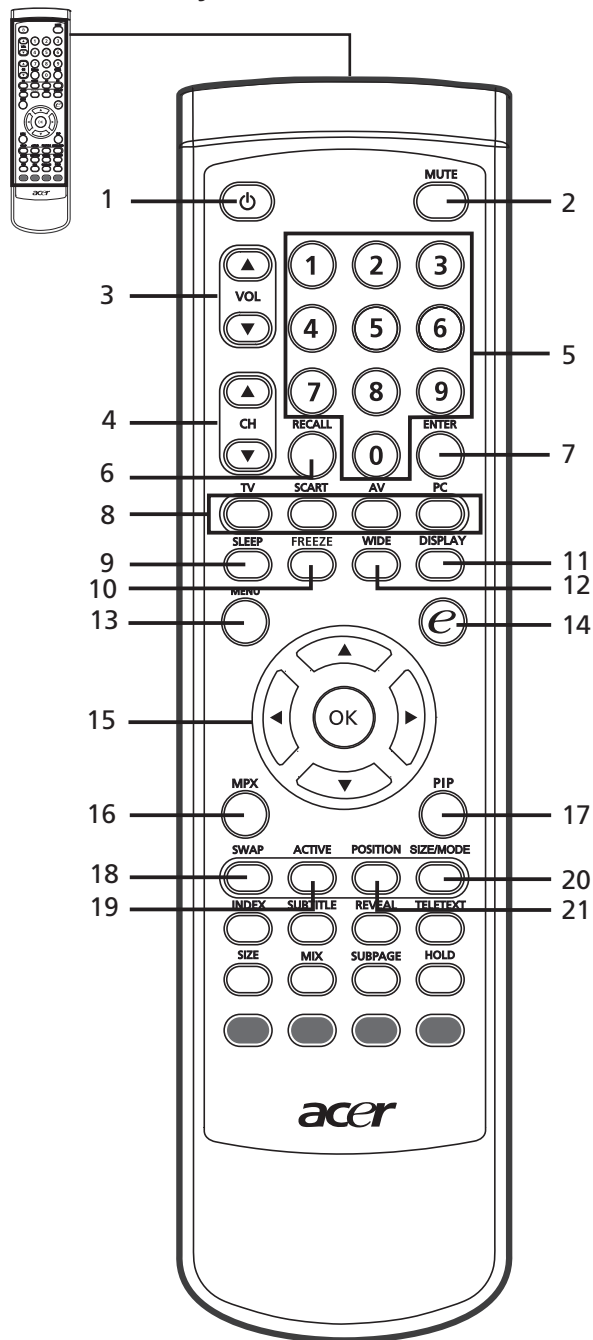

- 1 POWER**  
Press to turn your TV on/off.
- 2 MUTE**  
Press to toggle audio on and off.
- 3 VOL (up/down)**  
Press to increase or decrease the volume.
- 4 CH (up/down)**  
Press to sequentially select the TV channel.
- 5 Number keys.**
- 6 RECALL**  
Press to return to the previous channel.
- 7 ENTER**  
Press to confirm channel number selection.
- 8 Input buttons (TV/SCART/AV/PC)**  
Press to select correct input mode.
- 9 SLEEP**  
Press to set a time period after which the TV will switch itself to standby (15, 30, 45, 60, 90 or 120 minutes).
- 10 FREEZE**  
Press to freeze the displayed picture.
- 11 DISPLAY**  
Press to display input/channel information (dependent on input/source type).
- 12 WIDE**  
Press to toggle scaling mode between 4:3, 16:9, Panorama and Letterbox 1, 2, 3 modes.
- 13 MENU**  
Press to open or close the menu.
- 14 e (Empowering Technology)**  
Press to activate Acer Empowering Technology. See page 18.
- 15 Directional keys/OK**
- 16 MPX**  
Press to select the sound input, displayed in the top right-hand corner (mono, stereo, bilingual).
- 17 PIP**  
Press to display activate picture-in-picture (PIP). See page 20.
- 18 SWAP**  
Press to toggle between the primary and subscreens.
- 19 ACTIVE**  
Press to toggle between the control of primary and subscreens.
- 20 SIZE/MODE**  
Press to change subscreen size.
- 21 POSITION**  
Press to change subscreen position.



## Teletext

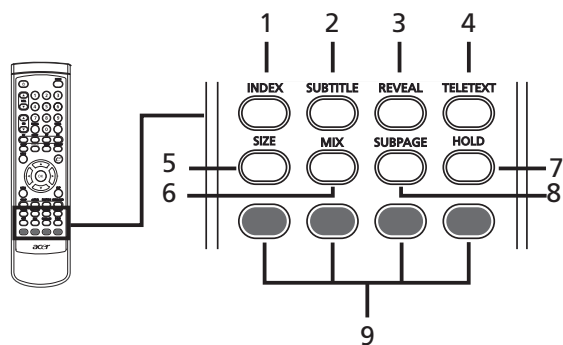

- 1 INDEX**  
Press to go to the index page
- 2 SUBTITLE**  
Press to view subtitles on the screen.
- 3 REVEAL**  
Press to reveal hidden teletext information
- 4 TELETEXT**  
Press to switch from TV/AV to Teletext mode.
- 5 SIZE**  
Press once to zoom teletext page to 2X.  
Press again to resume.
- 6 MIX**  
Press to overlay teletext page on the TV image.
- 7 HOLD**  
Press to pause the current teletext page in multi-page viewing mode.
- 8 SUBPAGE**  
Press to access the teletext's subpages directly.
- 9 Colour buttons (R/G/Y/B)**  
Operates corresponding button on the teletext page.



## Basic connections

### Connecting the power cord

- 1 Connect the AC cord into the AC input on the back of the set.
- 2 Connect the plug to the wall outlet as shown.

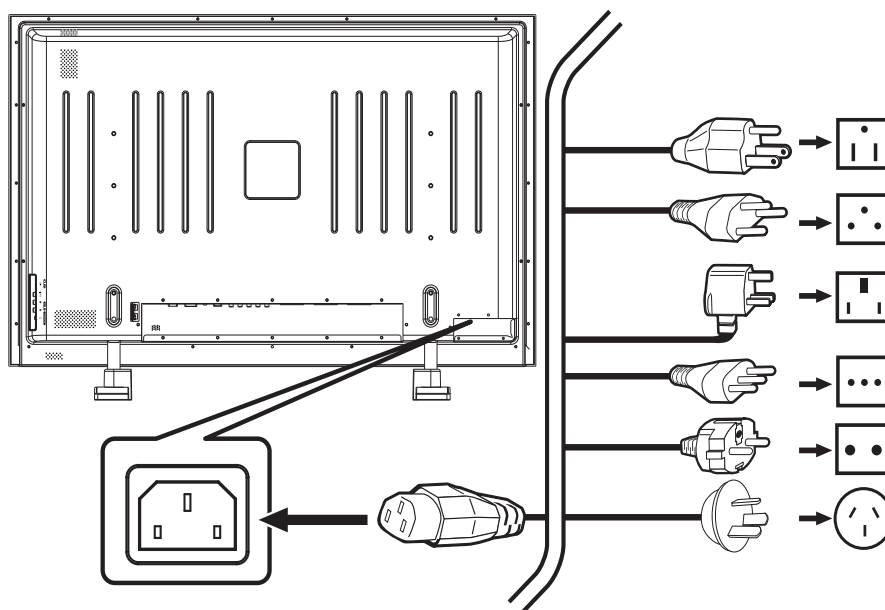

### Setting up the remote control

- 1 Open the cover on the back of the remote unit.

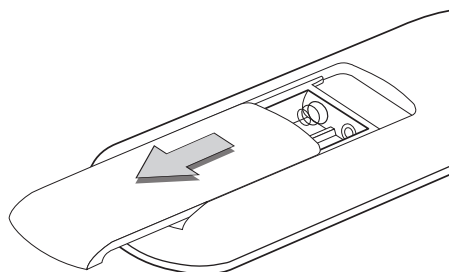

- 2 Insert two AAA batteries (supplied) to match the polarity indicated inside the battery compartment.

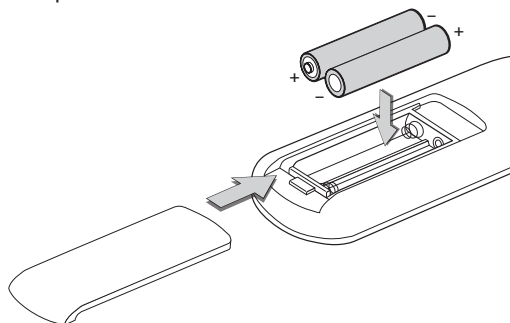

#### Looking after your remote control

|  |  |
|--|--|
|  | <ul style="list-style-type: none"> <li>• Handle the remote control with care. Dropping, wetting or placing the remote control in sunlight may damage it.</li> </ul>  |
|  | <ul style="list-style-type: none"> <li>• Do not tamper with batteries. Keep them away from children.</li> </ul>  |
|  | <ul style="list-style-type: none"> <li>• When you anticipate that the remote control will not be used for an extended period, remove the batteries to prevent possible damage as a result of battery leakage.</li> </ul> |
|  | <ul style="list-style-type: none"> <li>• Dispose of used batteries according to local regulations. Recycle if possible.</li> </ul>   |





## Enjoying analog TV

### Connecting an antenna/cable

Connect the antenna cable to the appropriate antenna terminal on the back of the TV set as shown below.

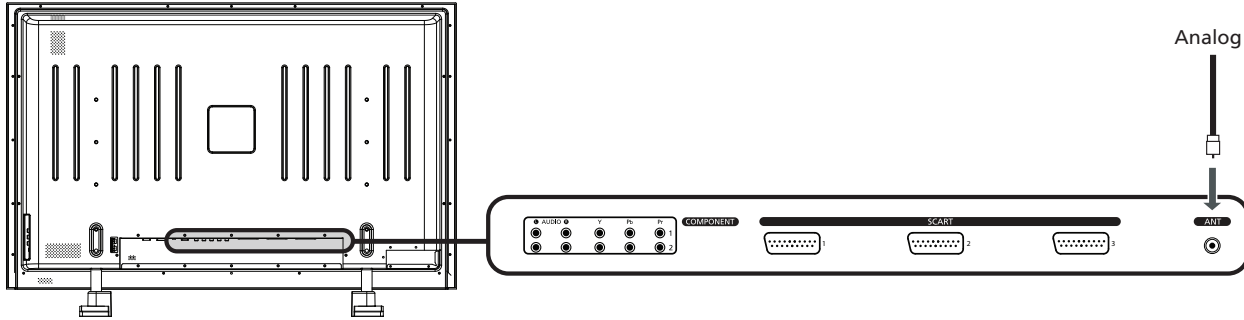

### Getting started watching your TV

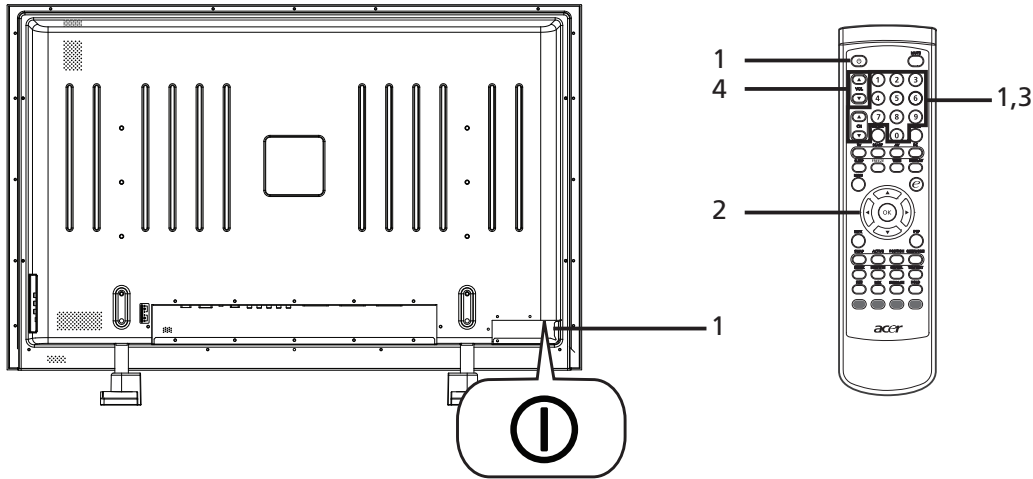

|   |                            |   |
|---|----------------------------|---|
| 1 | <p><b>Power</b></p>        | a. Turn on the power switch beneath the screen.   |
|   |                            | b. Press the <b>power</b> button, <b>number</b> keys or <b>channel up/down</b> button on the remote control.                  |
| 2 | <p><b>Setup Wizard</b></p> | The first time you switch on the TV, the Setup Wizard will guide you to complete the language selection and channel scanning. |
|   |                            | Press the <b>OK</b> key to begin the setup process.   |



You can also adjust these settings using the front control panel. Please see "Front panel view" on page 6 for details.





## Setup Wizard

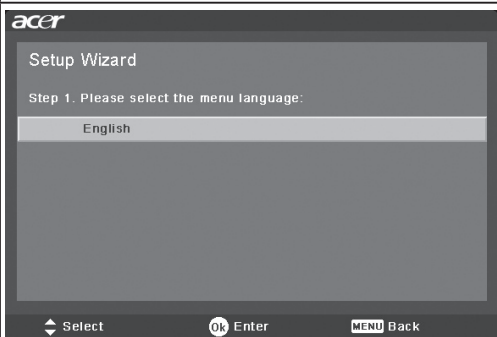

Step 1. Select the setup language you prefer.



Step 2. Please select country.

2

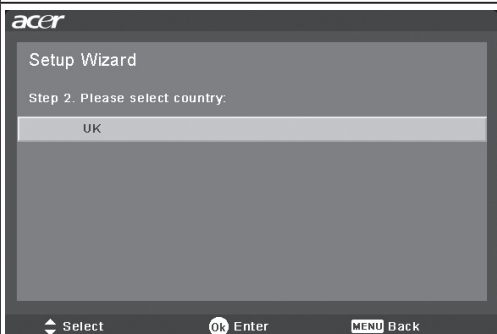

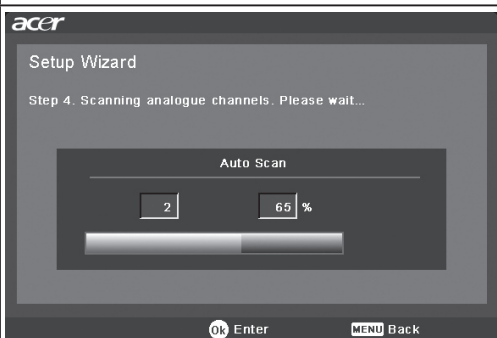

Step 3. Ensure that your co-axial cables are connected correctly before proceeding (see page 11 for details).



Step 4. Scan for analog channels.



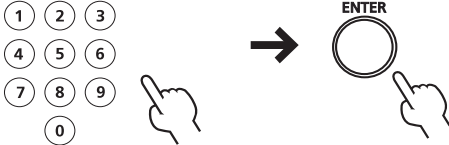

|                             |  |
|-----------------------------|--|
| <b>Setup Wizard</b>         |  |
| 2                           | <p>Step 5. Setup is now complete. You are ready to begin watching TV.</p> <p>If you leave the setup process before it is complete, you will be given a choice of options:</p> <ol style="list-style-type: none"> <li>1. Resume setup</li> <li>2. Resume setup at next startup</li> <li>3. Exit and don't remind me</li> </ol> <p>Select an option and press <b>OK</b> to exit.</p> |
|                             | <b>Changing channels</b>   |
| 3                           |  <p>a. Press 0-9 on the remote control to select a channel. Only the channel 1-9 will change after 2 seconds. Press <b>ENTER</b> to select the channel immediately.</p>   |
|                             |  <p>b. Pressing the channel (<b>CH</b>) up/down button on the remote control will also change the channel.</p>  |
| <b>Adjusting the volume</b> |  |
| 4                           |  <p>Adjust the volume level using the (<b>VOL</b>) up/down button on the remote control.</p>  |



Setup may vary due to local broadcast differences.





# Connecting external audio/video devices

## Connecting a DVD, VCR, STB or audio/video equipment

Connect your DVD player, VCR or audio/video equipment using the SCART port located at the rear of your PDP TV as shown below.

### Source-IN

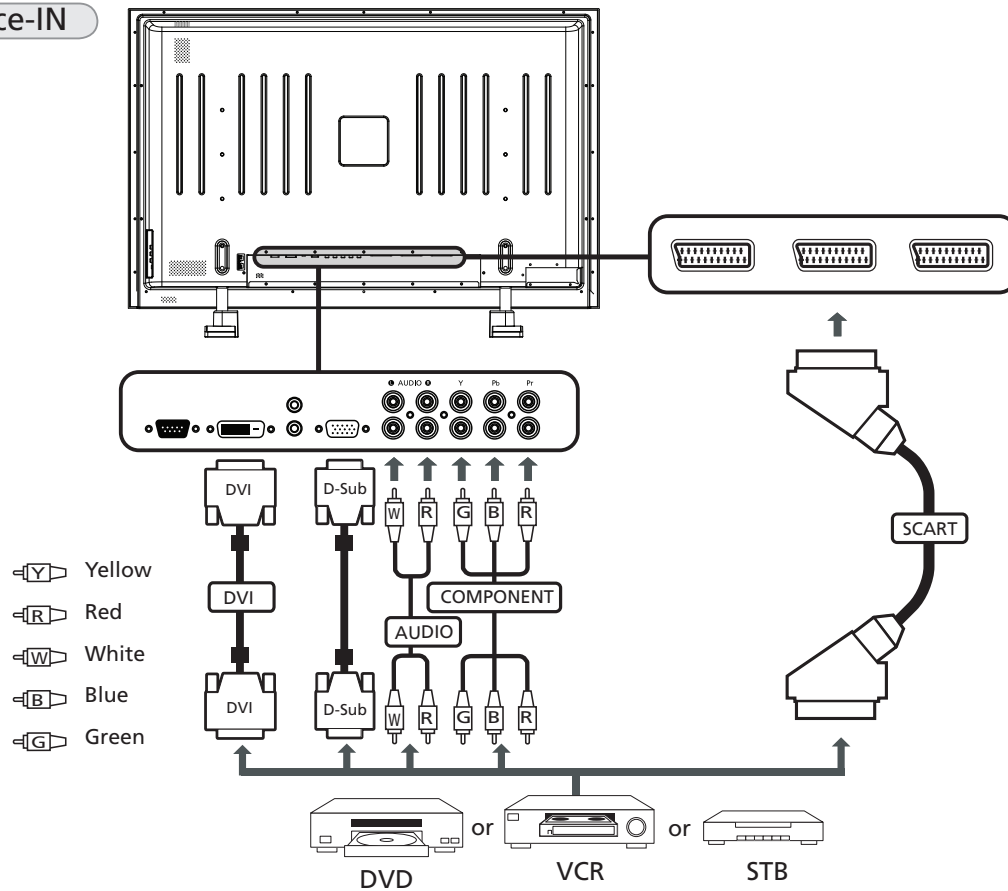

\*Acer recommends the following priority for connection types: DVI -> COMPONENT -> SCART -> S-VIDEO -> COMPOSITE.

### TV-OUT

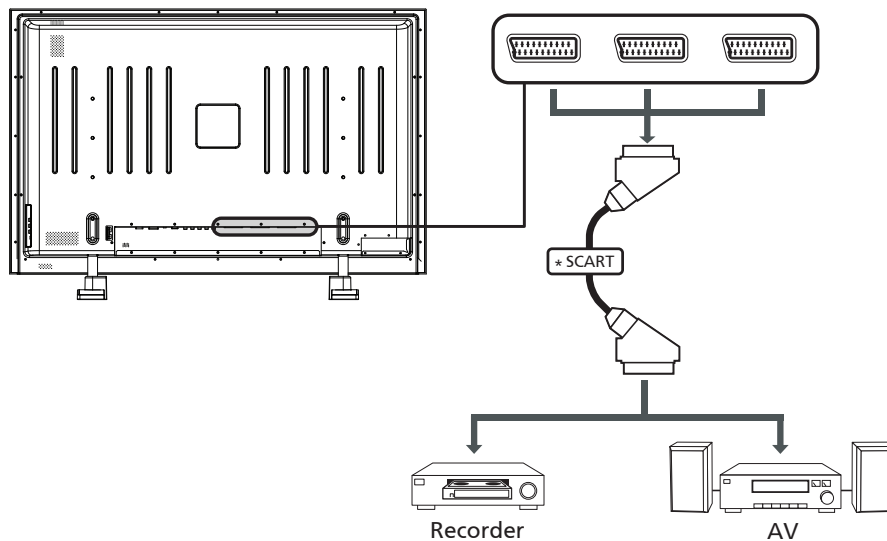

\*SCART-out only works with analog broadcasts.





## Connecting a camera, camcorder, video game or headphones

Connect your camera or camcorder to the video/audio ports on the bottom of the TV set as shown below.

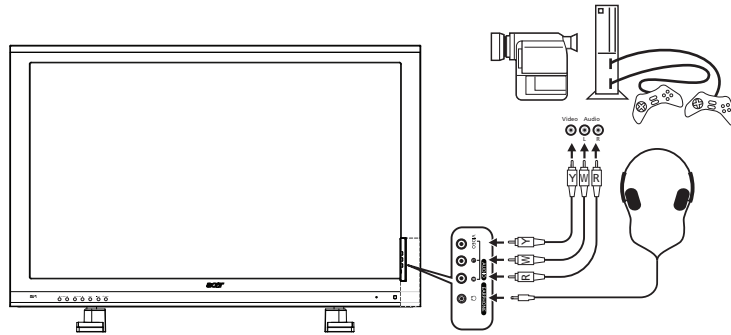

## Connecting a PC or notebook computer

To display PC output on your TV, connect your PC or notebook computer to the TV as shown below.

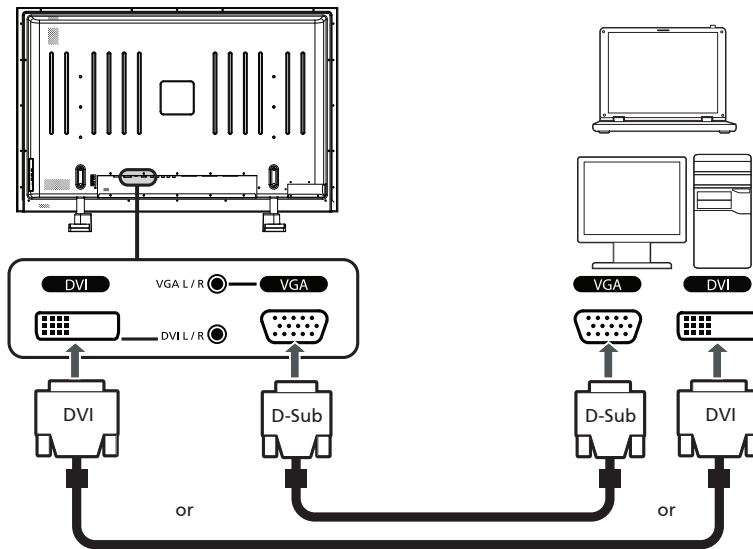

For VGA and DVI input, Acer recommends setting your PC's external monitor resolution up to 1,024 x 768 pixels @ 60 Hz refresh rate.

## Selecting the input source

Once you have connected your antenna or external equipment to the TV, you need to select the correct input source.

Press the corresponding button on the remote control to select the correct input source.

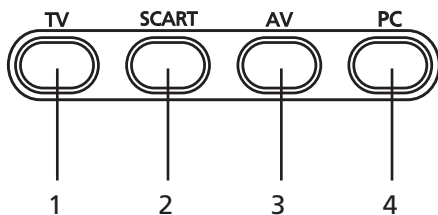

### Input button guide:

- 1 **TV key**  
Toggle Analog TV (ATV) between input sources.
- 2 **SCART key**  
Toggle SCART1 and SCART2 and SCART3 between input sources.
- 3 **AV key**  
Toggle AV4 and S-VIDEO and COMPONENT1 and COMPONENT2 between input sources.
- 4 **PC key**  
Toggle VGA and DVI between input sources.



## OSD navigation

Many of the advanced settings and adjustments are available through using the OSD (onscreen display) menus, as shown in the example screenshot below.

Basic operations required to navigate these menus (Picture, Audio, Channel management, Options, Settings, Empowering) are described in this section. The first time you access the OSD, you will be asked to choose your language settings.

### Navigating the OSD with the remote control

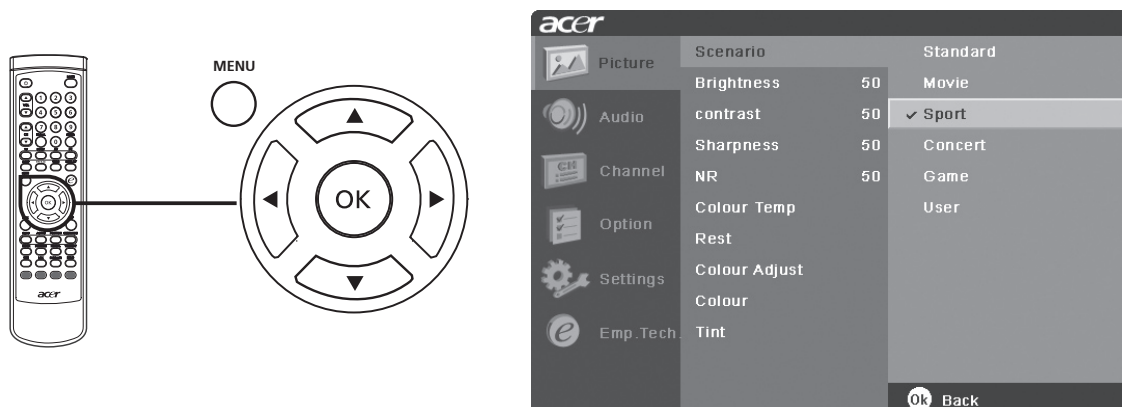

You can also interact with these menus using the front panel controls. Please see "Front panel view" on page 6 for details.

|  |  |   |
|--|--|---|
| There are six main OSD menus. These are: Picture, Audio, Channel management, Options, Settings and Empowering. Use the following method to navigate these menus. |  |   |
| 1  |  | Press the <b>MENU</b> button on the remote control or the <b>MENU</b> button on the control panel.  |
| 2  |  | Select your desired menu by using the up and down <b>directional keys</b> to switch between the six menus.  |
| 3  |  | Use the <b>directional keys</b> to interact with the menu. The up/down directions will scroll through the menu options, while left/right will adjust the different settings (for example, in the Picture menu, settings such as brightness, contrast, etc.). Press <b>OK</b> to confirm. Press <b>MENU</b> to exit. |





## Adjusting the OSD settings

The OSD can be used for adjusting the settings of your PDP TV.

Press the **MENU** key to open the OSD. You can use the OSD to adjust the picture quality, audio settings, channel settings, general settings and the Empowering Technology settings. For advanced settings, please refer to following page:

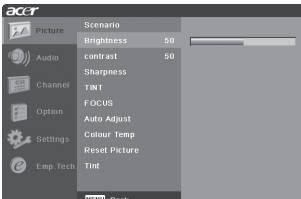
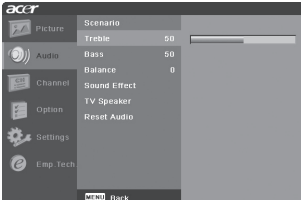
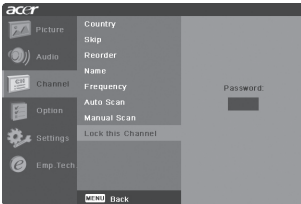
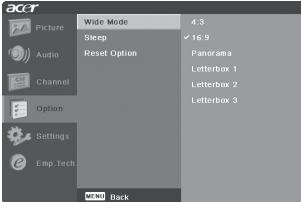
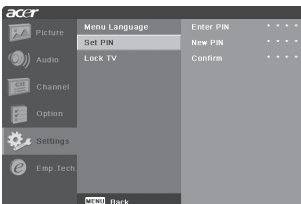
|   |  |
|---|--|
|    | <ol style="list-style-type: none"> <li>1 Press the <b>MENU</b> key to bring up the OSD.</li> <li>2 Using the directional keys, select <b>Picture</b> from the OSD. Then navigate to the picture element you wish to adjust.</li> <li>3 Use the left or right keys to adjust the sliding scales.</li> <li>4 The <b>Picture</b> menu can be used to adjust the current Scenario mode, brightness, contrast, colour, sharpness and other image-related qualities.</li> </ol>        |
|    | <ol style="list-style-type: none"> <li>1 Press the <b>MENU</b> key to bring up the OSD.</li> <li>2 Using the directional keys, select <b>Audio</b> from the onscreen display. Then navigate to the feature you wish to adjust.</li> <li>3 Use the left or right keys to adjust the sliding scales. Press <b>OK</b> to save.</li> <li>4 The <b>Audio</b> menu can also be used to adjust the treble, balance, sound effects and other important sound-related settings</li> </ol> |
|  | <ol style="list-style-type: none"> <li>1 Press the <b>MENU</b> key to bring up the OSD.</li> <li>2 Using the directional keys, select <b>Channel management</b> from the OSD.</li> <li>3 Use the directional keys to navigate the menus.</li> <li>4 The <b>Channel management</b> menu can be used to adjust, and set the TV ratings.</li> </ol>   |
|  | <ol style="list-style-type: none"> <li>1 Press the <b>MENU</b> key to bring up the OSD.</li> <li>2 Using the directional keys, select <b>Options</b> from the OSD.</li> <li>3 Use the directional keys to navigate the menus.</li> <li>4 The <b>Options</b> menu can be used to select the picture aspect-ratio mode, and set the sleep timer.</li> </ol>  |
|  | <ol style="list-style-type: none"> <li>1 Press the <b>MENU</b> key to bring up the OSD.</li> <li>2 Using the directional keys, select <b>Settings</b> from the OSD. Then navigate to the feature you wish to adjust.</li> <li>3 The <b>Settings</b> menu can be used to adjust the menu language, set the PIN, the TV censorship levels, and other important settings.</li> </ol>  |



The options available on the OSD may vary depending on the TV signal source.



## Empowering Technology

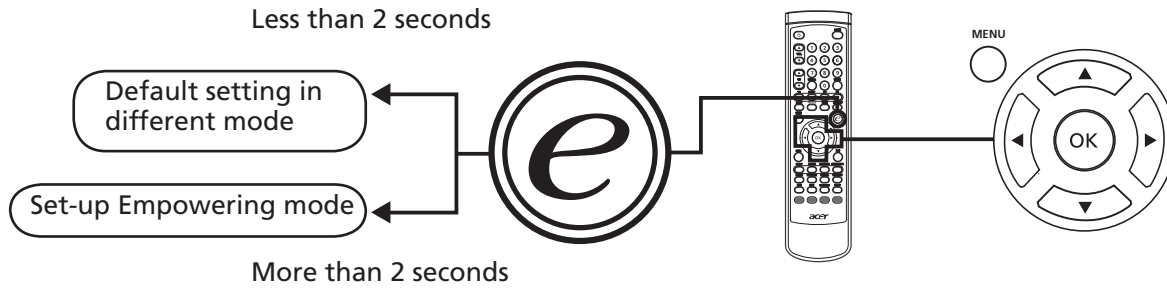

The Empowering Key opens up the Acer Empowering Technology functions. In TV mode, the choice is between Scenario mode and Favourite channel; see page 19 for details. The default setting for both modes is Scenario mode.

## Set-up Empowering mode

To change your Empowering Key's default setting:

|   |  |   |
|---|--|---|
| 1 |  | Press and hold the <b>Empowering Key</b> for more than <b>two seconds</b> to open the menu.   |
| 2 |  | <p style="text-align: center;">More than 2 seconds</p> <p style="text-align: center;"><b>TV mode Empowering Key settings menu</b></p> |
| 3 |  | Use the <b>directional keys</b> to navigate the menu and select the Empowering Technology icon.                                       |
| 3 |  | Press <b>MENU</b> to exit. Now, when you press the Empowering Key, your chosen selection will be accessed.                            |



## Default setting in different Empowering mode

### Scenario mode in TV (default setting)





Scenario mode has five preset viewing modes designed to give you the best picture quality when watching a particular kind of programme. There are five pre-defined audio and video settings for optimal enjoyment of the following scenarios: Standard TV, Movie, Game, Sports, Concert and User.

|  | Pressing the <b>Empowering Key</b> for less than <b>two seconds</b> will toggle between the different modes.   |
|---|--|
| Mode  | Information  |
| Standard  | Standard mode allows you to watch your favourite channels with sharp, brilliant imagery via adaptive brightness and contrast adjustments, and listen to clear-sounding audio.  |
| Movie   | For comfortably enjoying movies at home, Movie mode displays dim scenes in clear detail; compensates for colour; and smoothly presents motion images. This is accomplished through optimal Gamma correction plus saturation, brightness and contrast adjustments. Movie mode makes the most of high-definition movie soundtracks.  |
| Game  | Game mode carefully details the exquisite graphics of modern video games, providing lifelike entertainment while protecting your eyesight by adjusting brightness and contrast. What's more, Game mode provides a heightened audio experience.   |
| Sports  | Sports mode is suited for outdoor sports programmes, with accurate background depth and clear gradation between the bright, outdoor playing field and darker auditoriums. Sports mode also brilliantly enhances colours and presents swiftly moving pictures without residual images. All of this is achieved via specific Gamma corrections and saturation adjustments. Precise audio can be heard. |
| Concert   | Concert mode places you in a virtual concert hall, opera house or other dim environment by means of adaptive brightness and contrast adjustments. Concert mode accentuates symphonic harmonies and the tenor audio range.  |

### Favourite channel mode in TV

Favourite channel allows you to store five of your favourite TV channels and flick between them at the touch of a single button.

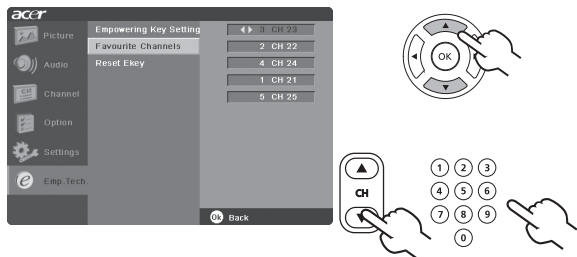
To set Favourite channel as the default, follow the steps described on page 18.

| Storing favourite channels      |   |
|---------------------------------|---|
| 1                               |  <p>Select your desired channel, then press the <b>MENU</b> key on the remote control.</p>   |
| 2                               |  <p>Use the <b>directional keys</b> to navigate the menu and select the Empowering Technology icon.</p>  |
| 3                               |  <p>Navigate to a channel slot, use CH up/down button or number key to change channel.</p> <p>There are a total of five slots in which you can store TV programmes.</p>                                    |
| Viewing your favourite channels |   |
|                                 |  <p>On the remote control, if you press the <b>Empowering Key</b> for less than two seconds, the TV will toggle between the five stored TV channels sequentially according to your list of favourites.</p> |



## Advanced features

### PIP

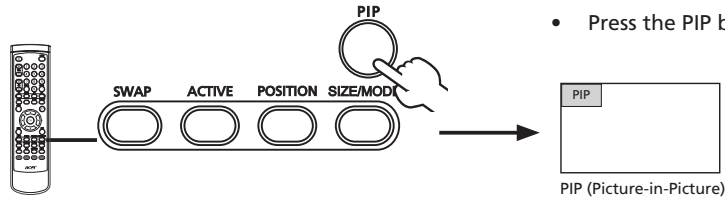

- Press the PIP button to display activate picture-in-picture (PIP).



1. For a list of the available sources for this feature, please refer to the appendix at the end of this manual.

|     |  |  |
|-----|--|--|
| PIP |  | 1a. Press the <b>ACTIVE</b> key to toggle between PIP screens.   |
|     |  | 1b. Press the <b>TV</b> , <b>SCART</b> , <b>AV</b> or <b>PC</b> keys, number keys or <b>CH</b> up or down to change the content of the active screen.          |
|     |  | 2. Press the <b>SWAP</b> key to change the content between the primary and the subscreen.  |
|     |  | 3. Press the <b>POSITION</b> key to select the location of the subscreens, from lower right -> lower left -> upper left -> upper right, as shown in the image. |
|     |  | 4. Press the <b>SIZE/MODE</b> key to select the size of the subscreen, from 37.5% -> 50%, as shown in the image.   |

## Audio effects

Your Acer PDP TV is equipped with high-quality sound specifications to ensure that you enjoy the best audio experience possible.



### SRS WOW

SRS WOW is a special combination of SRS audio technologies that creates a thrilling experience with deep, rich bass from any stereo sound source. Your audio sounds fuller, richer and wider. Based on the elements of SRS 3D technology, WOW restores the spatial cues and ambient information that are lost during standard stereo playback. Use the OSD to enable SRS WOW. Follow these steps : Menu>Audio>Sound Effect.



# Lock TV

## Locking TV content

Lock TV is a handy feature that can block a single channel, multiple channels or all TV sources.

Lock TV allows you to enter a password and effectively stop anyone without the password from watching TV.

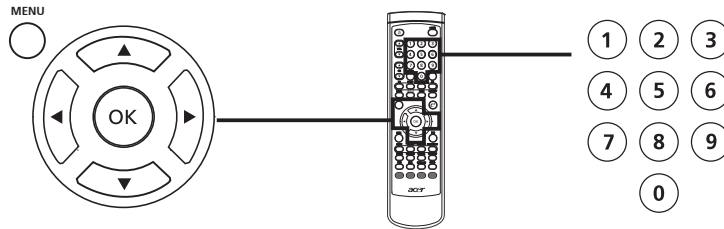

To enable this feature:





| Setting a personal PIN |  |  |
|------------------------|--|--|
| 1                      |  | <p>Press the <b>MENU</b> key on the remote control to bring up the OSD.</p>                                |
| 2                      |  | Use the <b>directional keys</b> to navigate to the  Settings menu. Then select <b>Set PIN</b> . (see note) |
| 3                      |  | Enter a four-digit password. Type it again and press <b>OK</b> to reconfirm.                               |
| 4                      |  | Press <b>MENU</b> to exit.   |



The default PIN for this TV is "0000." First enter "0000" when you want to change the PIN. If you forget your PIN, please enter 6163 to reset.

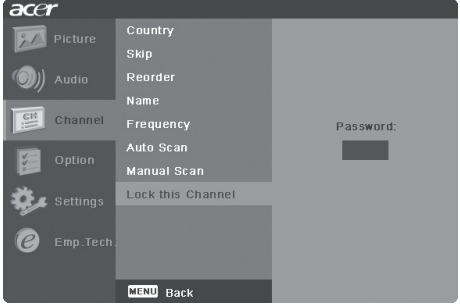

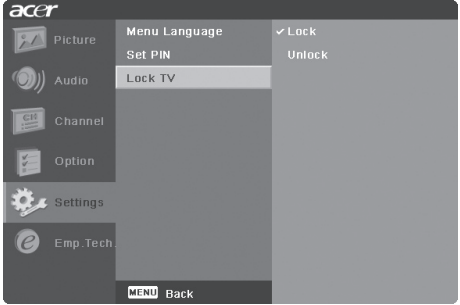

| Locking a single channel |  |  |
|--------------------------|--|--|
| 1                        |  | Navigate to the channel you wish to manage.  |
| 2                        |  |  <p>Press the <b>MENU</b> key on the remote control to bring up the OSD.</p>   |
| 3                        |  | Use the <b>directional keys</b> to navigate to the  Channel management menu. Then select <b>Lock This Channel</b> . |
| 4                        |  | Enter your PIN. Type it again and press <b>OK</b> to reconfirm.(see page 21)   |
| Locking your TV          |  |  |
| 1                        |  |  <p>Press the <b>MENU</b> key on the remote control to bring up the OSD.</p>                                       |
| 2                        |  | Use the <b>directional keys</b> to navigate to the  Settings menu. Then select <b>Lock TV</b> .                   |
| 3                        |  | Enter your PIN. Type it again and press <b>OK</b> to reconfirm.(see page 21 note)  |



## Re-scan for channels

The first time you completed the setup wizard, all available channels were listed. If you need to re-scan for new channels, please follow the steps below:

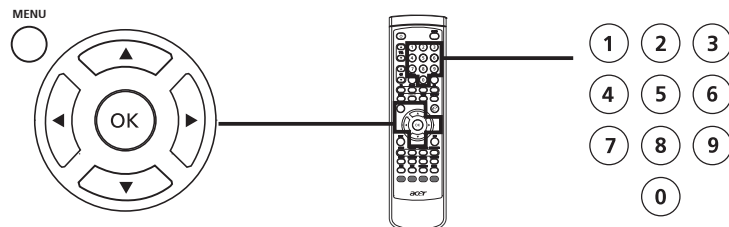

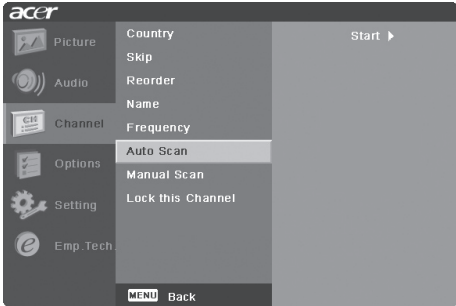
| Scanning for channels |  |   |
|-----------------------|--|---|
| 1                     |  | Press the <b>MENU</b> key on the remote control to bring up the OSD.  |
| 2                     |  | Use the <b>directional keys</b> to navigate and select  Channel Management.   |
| 3                     |  |  <p>Highlight <b>Auto Scan</b>. Then, select <b>Start</b> and press <b>OK</b> to begin.</p> |
| 4                     |  | Select <b>OK</b> and press <b>MENU</b> to exit.   |



## Widescreen display mode

Your Acer PDP TV has a special widescreen mode that allows you to toggle between 4:3, 16:9, Panorama, and Letterbox 1, 2 and 3 type views.

Press the **WIDE** key on the remote control to toggle the display between the four wide modes.

### Wide mode

The Acer PDP contains four widescreen modes, including 4:3, 16:9, Panorama, and Letterbox 1, 2 and 3.

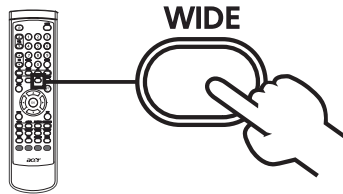

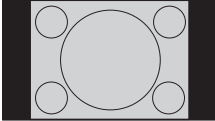
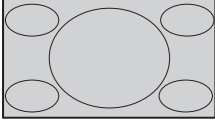
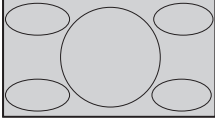
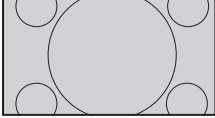
|                       |   |
|-----------------------|---|
| 4:3                   |  <p>For 4:3 standard pictures. A side bar appears on each side.</p>   |
| 16:9                  |  <p>In this mode, the whole picture is stretched toward each side of the screen.</p>   |
| Panorama              |  <p>In this mode, the picture is progressively stretched toward each side of the screen.</p>   |
| Letterbox 1, 2, and 3 |  <p>In this mode, the picture is enlarged linearly to fit the screen. The top and bottom portions of the picture may be cut off.</p> |







# Dimensions

AT4202P

English

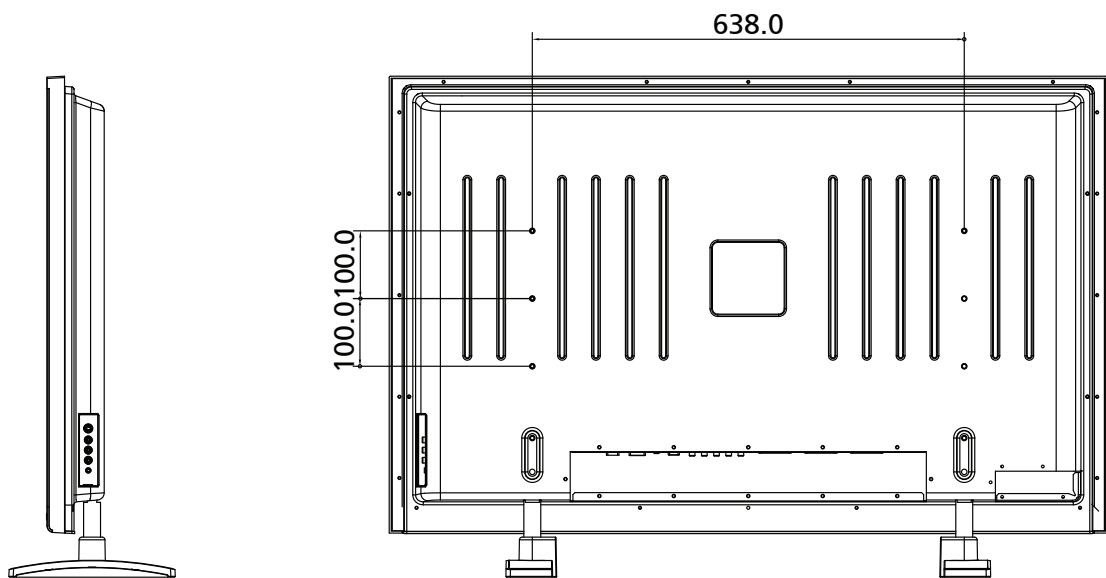
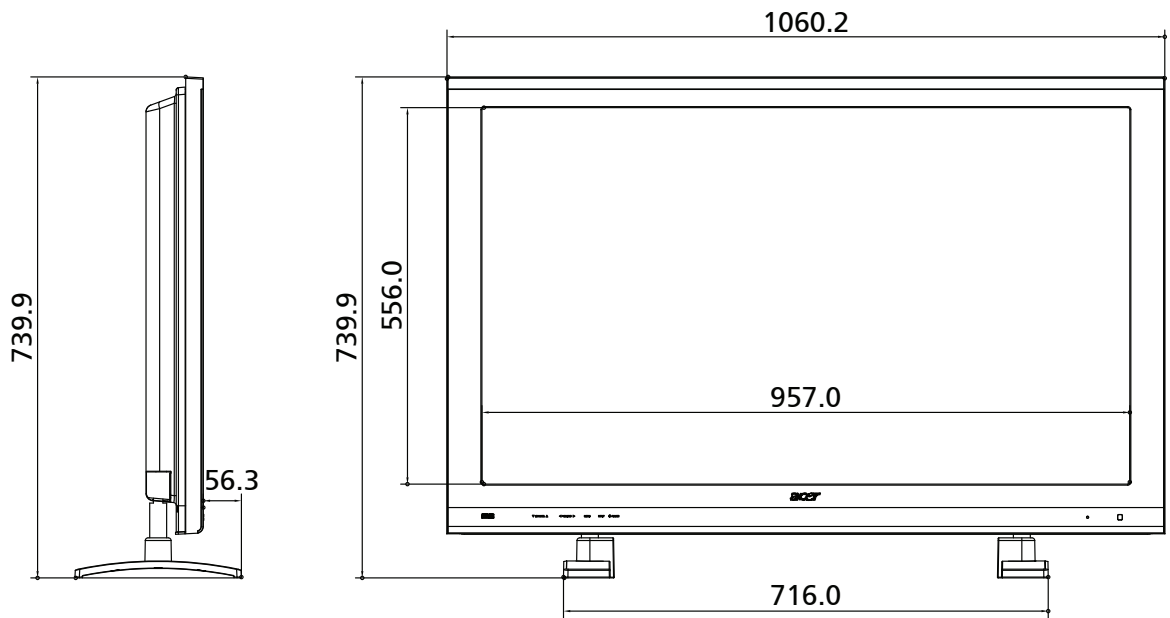

Unit: mm

## Appendix-Source Options

### PIP

| Sub \ Main    | TV | AV1 - SCART1 | AV2 - SCART2 | AV3 - SCART3 | COMPONENT1 | COMPONENT2 | AV4 - CVBS | AV4 - S-VIDEO | VGA | DVI-D (HDCP) |
|---------------|----|--------------|--------------|--------------|------------|------------|------------|---------------|-----|--------------|
| TV            | X  | ●            | ●            | ●            | ●          | ●          | ●          | ●             | ●   | ●            |
| AV1 - SCART1  | ●  | X            | X            | X            | ●          | ●          | ●          | ●             | ●   | X            |
| AV2 - SCART2  | ●  | X            | X            | X            | ●          | ●          | ●          | ●             | ●   | X            |
| AV3 - SCART3  | ●  | X            | X            | X            | ●          | ●          | ●          | ●             | ●   | X            |
| COMPONENT1    | X  | X            | X            | X            | X          | X          | X          | X             | X   | X            |
| COMPONENT2    | X  | X            | X            | X            | X          | X          | X          | X             | X   | X            |
| AV4 - CVBS    | ●  | ●            | ●            | ●            | ●          | ●          | X          | ●             | ●   | ●            |
| AV4 - S-VIDEO | X  | X            | X            | X            | X          | X          | X          | X             | X   | ●            |
| VGA           | X  | X            | X            | X            | X          | X          | X          | X             | X   | X            |
| DVI-D (HDCP)  | X  | X            | X            | X            | X          | X          | X          | X             | X   | X            |

●: Supported  
X: Not supported

## Troubleshooting

Before you call the Acer service center, please check the following items:

Here is a list of possible situations that may arise during the use of your PDP TV. Easy answers and solutions are provided for each.

### There is no picture or sound.

- Make sure the power cord is properly inserted in the power outlet.
- Make sure the input mode is correctly set by your selected input.
- Make sure the antenna at the rear of the TV is properly connected.
- Make sure the main power switch is turned on.
- Make sure the volume is not set to minimum or the sound is not set to mute.
- Make sure the headphones are not connected.
- Reception other than those of broadcasting stations can be considered.

### Picture is not clear.

- Make sure the antenna cable is properly connected.
- Consider whether your TV signal is being properly received.
- Poor picture quality can occur due to a VHS camera, camcorder, or other peripheral being connected at the same time. Switch off one of the other peripherals.
- The 'ghost' or double image may be caused by obstruction to the antenna due to high-rise buildings or hills. Using a highly directional antenna may improve the picture quality.
- The horizontal dotted lines shown on the pictures may be caused by electrical interference, e.g., hair dryer, nearby neon lights, etc. Turn off or remove these.

### Picture is too dark, too light or tinted.

- Check the colour adjustment.
- Check the brightness setting.
- Check the sharpness function.
- The fluorescent lamp may have reached the end of its service life.

### Remote control does not work.

- Check the batteries of the remote control.
- Make sure the remote sensor window is not under strong fluorescent lighting.
- Try to clean the remote control sensor lens on the TV with a soft cloth.
- Use the buttons (hotkeys) on the TV before the remote control works.

If the above suggestions do not solve your technical issue, please refer to the warranty card for service information.

## Product specifications

|                             |   |
|-----------------------------|---|
| Model                       | AT4202P   |
| <b>Panel spec</b>           |   |
| Resolution (pixels)         | 852 x 480   |
| Brightness (tpe.)           | 1300 cd/m <sup>2</sup>  |
| Contrast Ratio (tpe.)       | 10,000:1  |
| Display colour              | 30 bits, 68.7 million   |
| <b>Power supply</b>         |   |
| Input                       | 100V~240V -AC. (50/60 HZ)   |
| Max. power consumption      | <300 W  |
| Power saving                | 5W  |
| <b>Mechanical</b>           |   |
| Dimensions (W x H x D mm)   | 1220 x 950 x 455  |
| Weight (Kg)                 | 42  |
| Weight (lbs)                | 90  |
| Wall Mounting (mm)          | Yes   |
| <b>Video signals</b>        |   |
| Video synchronization range | Horizontal 31 to 69 KHz, Vertical: 56.0 to 75 Hz  |
| Max sample clock frequency  | 110 MHz   |
| Max support resolution      | 1024 x 768, 60Hz  |
| <b>Analog TV system</b>     |   |
| TV Colour system            | PAL, SECAM L/L'   |
| Mono system                 | FM D/K, AM L, FM B,G, FM I  |
| Stereo system               | FM B/G, NICAM DK, NICAM I, NICAM L/L'   |
| TV Tuner System             | PLL, 45.25Mhz-862.25Mhz   |
| TELETEXT                    | Level 1.5, 1,000 pages  |
| Analog TV-tuner quantity    | 1   |
| YUV colour system           | 480i, 480p, 1080i, 720p, 576i, 576p   |
| <b>Terminal</b>             |   |
| AV1                         | SCART 21 pin (CVBS, Y/C, RGB: Auto detect Full function with Audio output), Fast blanking |
| AV2                         | SCART 21 pin (CVBS, Y/C, RGB: Auto detect Full function with Audio output)                |
| AV3                         | SCART 21 pin (CVBS, Y/C, RGB: Auto detect Full function W/O Audio output)                 |
| AV4                         | RCA for CVBS, Audio R/L RCA   |
| S-Video                     | S DIN for S-Video, Audio R/L RCA share with AV4   |
| COMPONENT1                  | RCA for YPbPr/YCbCr, Audio R/L RCA  |
| COMPONENT2                  | RCA for YPbPr/YCbCr, Audio R/L RCA  |
| DVI-D (HDCP)                | Yes (with HDCP), Audio 3.5 mm jack phone  |
| VGA                         | D-Sub 15 pin, Audio 3.5 mm jack phone   |
| Headphone                   | Yes   |
| <b>Audio system</b>         |   |
| Speaker                     | 4 W + 4 W   |
| External (Optional)         | External speakers terminals (optional 8W + 8W, 4 ohm)                                     |