

AC701 CRT Monitor



User's Manual

acer

Table of Contents

Important Safety Instructions.....	3
Federal Communications Commission.....	5
Connecting the Monitor and Swivel Base.....	6
Removing the Monitor and Swivel Base.....	6
Introduction	7
Installation	8
User Controls	9
OSD Function Description	10
OSD Icon Summary	11
Specification.....	12
Troubleshooting	13

Important Safety Instructions

1. Please read these instructions thoroughly.
2. Please keep this guide for future use.
3. Please disconnect the device from the main power supply before cleaning. Do not use any liquids or aerosol sprays to clean this device. Use a clean dampened cloth in stead.
4. To avoid damaging the device, only use factory-approved accessories.
5. Protect the device against moisture.
6. In order to set up the device, first place it on a stable surface. Tipping it over or dropping can harm the monitor and cause injuries. Please follow the setup instructions of the manufacturer while setting up your monitor.
7. The ventilation openings are used for air circulation to protect the device against overheating.
8. When connecting the device, obey the maximum connected load values of the main power supply.
9. The wall socket must be equipped with a non-fused grounded conductor contact for electrical safety.
10. The power cable must be laid in such a way nobody can trip over it. Please do not place any objects on the cable.
11. Follow all instructions and warning remarks that are printed on the device.
12. If the device will not be used for a long period of time, please disconnect it from the main power supply to avoid power surge damage such as lightning.
13. Make sure no sharp objects or liquids enter the device via its air circulation openings. This could result in a fire or an electric shock.
14. Never open the device casing yourself, there are no user serviceable parts inside. Only authorized technical service personnel should open the casing of this device.
15. If any of the following conditions occur, the device must be disconnected from the main supply, and be checked by a qualified service center:
 - a- Power cable or power plug are damaged;
 - b- Liquid has entered the device;
 - c- The device was exposed to moisture;
 - d- The device does not operate according to the user's guide, or you do not achieve any improvement with the aid of this guide;
 - e- The device has been dropped and/or the casing is damaged;

- f- The device shows obvious signs of a defect.
- 16. Use only approved original spare parts, or parts in accordance with the original parts, for repairs. The use of incorrect/unauthorized spare parts may cause further damage.
- 17. Please contact your service center for any questions regarding service and repairs to guarantee the device's performance and reliability.
- 18. The power socket must be installed near the equipment to be easily accessible.

Federal Communications Commission

(FCC Statement)

This equipment has been tested and found to comply with the limits for a Class B digital device, pursuant to Part 15 of the FCC Rules. These limits are designed to provide reasonable protection against harmful interference in a residential installation. This equipment generates, uses, and can radiate radio frequency energy, and, if not installed and used in accordance with the instructions, may cause harmful interference to radio communications. However, there is no guarantee that interference will not occur in a particular installation. If this equipment does cause harmful interference to radio or television reception, which can be determined by turning the equipment off and on, the user is encouraged to try to correct the interference by one or more of the following measures:

- Reorientate or relocate the receiving antenna;
- Increase the separation between the equipment and receiver;
- Connect the equipment with a power socket on a circuit different from that to which the receiver is connected;
- Consult the dealer or an experienced radio/TV technician for help.

Any changes or modifications not expressly approved by the manufacturers may void the user's authority to operate this equipment.



A shielded-type video signal cable is required in order to meet the FCC emission limits and also to prevent interference to nearby radio and television reception. It is essential that only the supplied power cord be used.

Use only shielded cables to connect I/O devices to this equipment.



Canadian DOC Notice

For Class B Computing Devices

This Class B digital apparatus meets all requirements of the Canadian Interference-Causing Equipment Regulations.

Cet appareil numérique de la classe B respecte toutes les exigences du Règlement sur le matériel brouilleur du Canada.

Connecting the Monitor and Swivel Base

1. Place the monitor with its tube down on a stable surface.
2. Align the four tabs of the swivel base with the slots in the bottom of the monitor.
3. Insert the tabs into the slots of the monitor
4. Now slowly slide the swivel base toward the front of the monitor till you hear the spring lock click into place.

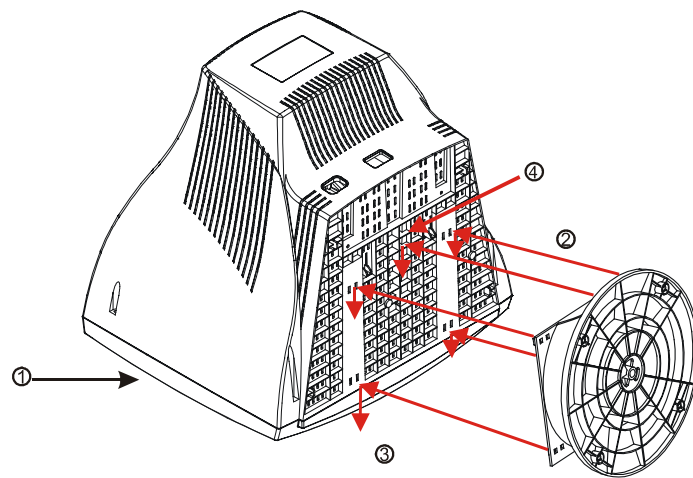

Removing the Monitor and Swivel Base

If you need to remove the swivel base, push the spring lock and then pull the swivel base away from the monitor.

NOTE: Special attention should be paid to the control knobs and LED indicators on the front panel when you place the monitor with its tube down. This will prevent damage to these control knobs and LED indicators from excessive pressure.

Introduction

Congratulations on your purchase of this new high performance 17" Monitor. Using state-of-the-art electronics, this monitor supports a 1280 x 1024 resolution. The on-screen display allows you to customize the display settings to suit your individual taste.

Features

- 17-inch monitor with a large, viewable screen for comfortable viewing.
- OSD user controls for easy and accurate adjustment of the screen image.
- Energy Star compliant for reduced power consumption.

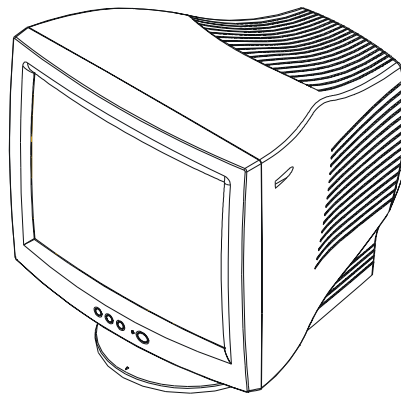

Package Overview

Please make sure the following items are in the packing it was shipped in, and found in good working condition:

- 17" Monitor
- Power Cord
- Tilt and Swivel Base
- This User's manual

Please contact your dealer or nearest service centers if any of the above items is missing or damaged.

Installation

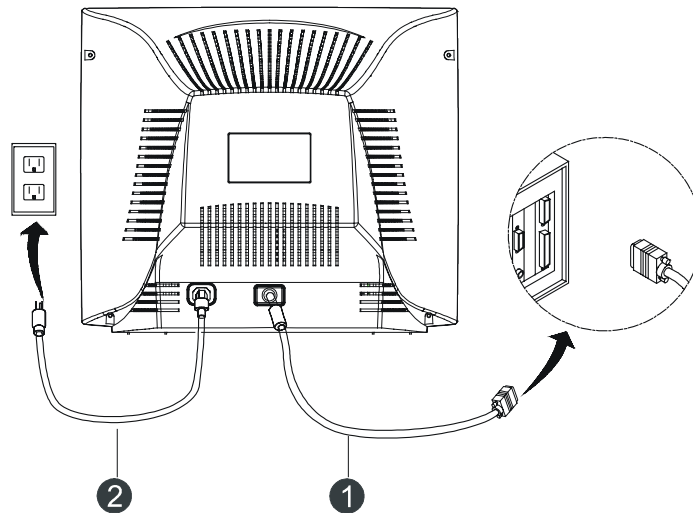

1. Connect the monitor signal cable **1** to the 15-pin mini D-sub (VGA) on the back of the computer.
2. Connect the power cord **2** to the power connector on the back panel of the monitor, then plug the other end into an electrical outlet that is easily accessible, and close to the monitor.
3. First turn on the power of the computer, then that of the monitor.
4. Adjust the tilt of the swivel base for maximum viewing comfort.

The installation of your monitor is now complete.

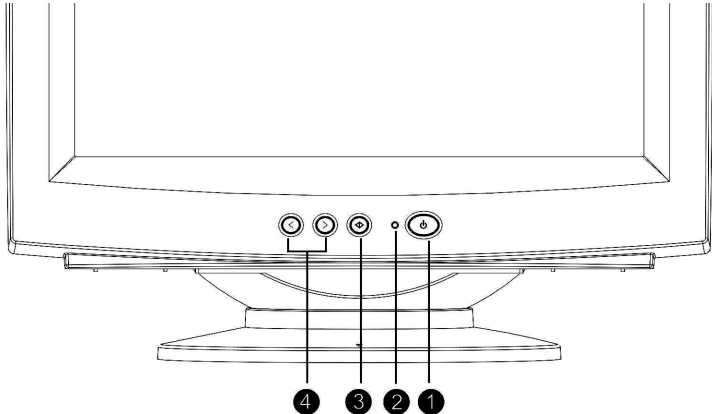

User Controls



1. Power Switch

 Turns the monitor on



2. Power LED Indicator

<u>LED color</u>	<u>Status</u>
 Green	On
 Amber	Sleep

3. Select Button







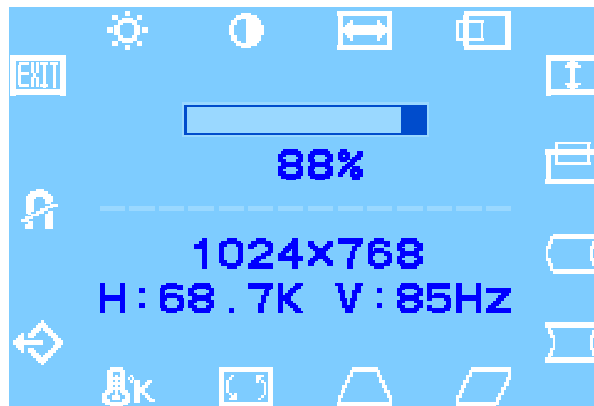

-  Launches On -Screen Display
- Make sure the select functions or adjustments
- Exit menus and On-Screen Display

4. Backward and Forward Buttons















-   Backward button (left arrow) moves backward through menu options or decreases adjustment levels.
- Forward button (right arrow) moves forward through menu options or increases adjustment levels.

OSD Function Description



1. Press the  key to display the OSD menu.
2. To select a function, press the  and  keys until the desired function is highlighted.
3. Press the  key to choose the function.
4. Use the  and  keys to increase or decrease the parameter level of the setting.
5. Press the  key to save the new setting.
6. Select the  icon if you want to exit the OSD function, and then press the  key once.

OSD Icon Summary

Icon	Function	Function Description
	Brightness	Adjusts display brightness
	Contrast	Adjusts display contrast
	H. Size	Increases and decreases screen width
	H. Position	Shifts display image right or left
	V. Size	Increase and decrease screen height
	V. Position	Shifts display image up or down
	Pin. Balance	Adjusts each side of Pincushion
	Pincushion	Adjusts concave and convex portion of pincushion effect
	Parallelogram	Adjusts the tilt of the display sides to the left or right
	Trapezoid	Adjusts the top and bottom display widths
	Rotation	Adjusts the rotation of the display clock or anti-clockwise
	Color Temp.	Adjusts the warmth of the displayed colors
	Reset	Resets to default values
	Degauss	Demagnetizes the screen to reduce color impurities
	Exit	Exits the OSD menu

Specification

Screen	
Size	17" CRT
Dot Pitch (mm)	0.28
Surface	Non -glare
Viewable Image Area	16.14" (41.0 cm)
Input Signal	
Video Sync.	RGB Analog 0.7Vp-p/75 Ohm a. Separate H/V,TTL(+/-) b. Composite H+V,TTL(+/-)
Scanning Frequency	
Horizontal (KHz)	30-70
Vertical (Hz)	50-160
Max. Resolution	1280 x 1024
Signal Cable	
	15-pin mini D-sub
Power	
Consumption	Max. 75 W
Power Supply	100 - 240VAC (W/I CE Mark) 50/60Hz
Power Management	Complies with EPA Energy Star ,VESA, Nutek
Display Modes	
Preset	6
By User	14
Operating	
Operating Temperature	0-40°C
Relative Humidity	10-90 %
Dimensions (L x W x H)	
	419 x 405 x 427 (mm)
Weight	
Unpacked	14.9 Kgs
Packed in box	16.8 Kgs

Troubleshooting

Please refer to the following solutions for the failure symptoms that occur the most frequent. If the symptom remains after trying these suggested solutions, please contact your local authorized service center.

Problem: Power LED is not lit when monitor is powered on.

- Check to make sure that the power cord is connected properly.
- Make sure that the extension cord or the surge protector is turned on if the monitor is plugged into a power extension cord or a surge protector.

Problem: No display appears on screen.

- Make sure that the computer switch is in the "On" position.
- Make sure that the video cable's D-shaped connector is properly connected to the video adapter port on the back of the PC.
- Check to make sure that the brightness and contrast controls are not turned to their dimmest position.

Problem: Display image is either flickering or unstable.

- Make sure that the video cable's D-shaped connector is connected properly to the video adapter port on the back of the PC.

Problem: Image is bouncing or in a wave pattern.

- Move any electrical devices that can cause interference away from the monitor.
(Note: Please refers to the FCC statement at the beginning of the manual for more details on display interference.)