

TABLE OF CONTENTS

Special notes on LCD monitors	1
Information for your safety and comfort	2
Unpacking	5
Attaching/Removing the base	6
Screen position adjustment	6
Connecting the power cord	7
Safety precaution	7
Cleaning your monitor	7
Power saving	8
DDC	8
Connector Pin Assignment	9
Standard Timing Table.....	11
Installation.....	12
User controls.....	13
Troubleshooting.....	19

SPECIAL NOTES ON LCD MONITORS

The following symptoms are normal with LCD monitor and do not indicate a problem.

NOTES

- Due to the nature of the fluorescent light, the screen may flicker during initial use. Turn off the Power Switch and then turn it on again to make sure the flicker disappears.
- You may find slightly uneven brightness on the screen depending on the desktop pattern you use.
- The LCD screen has effective pixels of 99.99% or more. It may include blemishes of 0.01% or less such as a missing pixel or a pixel lit all of the time.
- Due to the nature of the LCD screen, an afterimage of the previous screen may remain after switching the image, when the same image is displayed for hours. In this case, the screen is recovered slowly by changing the image or turning off the Power Switch for hours.

Information for your safety and comfort

Safety instructions

Read these instructions carefully. Keep this document for future reference. Follow all warnings and instructions marked on the product.

CAUTION for accessibility

Be sure that the power outlet you plug the power cord into is easily accessible and located as close to the equipment operator as possible. When you need to disconnect power to the equipment, be sure to unplug the power cord from the electrical outlet.

Warnings

- Do not use this product near water.
- Do not place this product on an unstable cart, stand or table. If the product falls, it could be seriously damaged.
- Slots and openings are provided for ventilation to ensure reliable operation of the product and to protect it from overheating. These openings must not be blocked or covered. The openings should never be blocked by placing the product on a bed, sofa, rug or other similar surface. This product should never be placed near or over a radiator or heat register, or in a built-in installation unless proper ventilation is provided.
- Never push objects of any kind into this product through cabinet slots as they may touch dangerous voltage points or short-out parts that could result in a fire or electric shock. Never spill liquid of any kind onto or into the product.
- To avoid damage of internal components and to prevent battery leakage, do not place the product on a vibrating surface.
- Never use it under sporting, exercising, or any vibrating environment which will probably cause unexpected short current or damage rotor devices, HDD, Optical drive, and even exposure risk from lithium battery pack.

Safe listening

Follow these instructions, suggested by hearing experts, to protect your hearing.

- Gradually increase the volume until you can hear it clearly and comfortably and without distortion.
- After setting the volume level, do not increase it after your ears adjust.
- Limit the amount of time listening to music at high volume.
- Avoid turning up the volume to block out noisy surroundings.
- Turn the volume down if you can't hear people speaking near you.

Product servicing

Do not attempt to service this product yourself, as opening or removing covers may expose you to dangerous voltage points or other risks. Refer all servicing to qualified service personnel.

Unplug this product from the wall outlet and refer servicing to qualified service personnel when:

- the power cord or plug is damaged, cut or frayed
- liquid was spilled into the product
- the product was exposed to rain or water
- the product has been dropped or the case has been damaged
- the product exhibits a distinct change in performance, indicating a need for service
- the product does not operate normally after following the operating instructions



Note: Adjust only those controls that are covered by the operating instructions, since improper adjustment of other controls may result in damage and will often require extensive work by a qualified technician to restore the product to normal condition.

LCD Pixel Statement

The LCD unit is produced with high-precision manufacturing techniques. Nevertheless, some pixels may occasionally misfire or appear as black or red dots. This has no effect on the recorded image and does not constitute a malfunction.

Tips and information for comfortable use

Computer users may complain of eyestrain and headaches after prolonged use. Users are also at risk of physical injury after long hours of working in front of a computer. Long work periods, bad posture, poor work habits, stress, inadequate working conditions, personal health and other factors greatly increase the risk of physical injury.

Incorrect computer usage may lead to carpal tunnel syndrome, tendonitis, tenosynovitis or other musculoskeletal disorders. The following symptoms may appear in the hands, wrists, arms, shoulders, neck or back:

- numbness, or a burning or tingling sensation
- aching, soreness or tenderness
- pain, swelling or throbbing
- stiffness or tightness
- coldness or weakness

If you have these symptoms, or any other recurring or persistent discomfort and/or pain related to computer use, consult a physician immediately and inform your company's health and safety department.

The following section provides tips for more comfortable computer use.

Finding your comfort zone

Find your comfort zone by adjusting the viewing angle of the monitor, using a footrest, or raising your sitting height to achieve maximum comfort. Observe the following tips:

- refrain from staying too long in one fixed posture
- avoid slouching forward and/or leaning backward
- stand up and walk around regularly to remove the strain on your leg muscles

- take short rests to relax your neck and shoulders
- avoid tensing your muscles or shrugging your shoulders
- install the external display, keyboard and mouse properly and within comfortable reach
- if you view your monitor more than your documents, place the display at the center of your desk to minimize neck strain

Taking care of your vision

Long viewing hours, wearing incorrect glasses or contact lenses, glare, excessive room lighting, poorly focused screens, very small typefaces and low-contrast displays could stress your eyes. The following sections provide suggestions on how to reduce eyestrain.

Eyes

- Rest your eyes frequently.
- Give your eyes regular breaks by looking away from the monitor and focusing on a distant point.
- Blink frequently to keep your eyes from drying out.

Display

- Keep your display clean.
- Keep your head at a higher level than the top edge of the display so your eyes point downward when looking at the middle of the display.
- Adjust the display brightness and/or contrast to a comfortable level for enhanced text readability and graphics clarity.
- Eliminate glare and reflections by:
 - placing your display in such a way that the side faces the window or any light source
 - minimizing room light by using drapes, shades or blinds
 - using a task light
 - changing the display's viewing angle
 - using a glare-reduction filter
 - using a display visor, such as a piece of cardboard extended from the display's top front edge
- Avoid adjusting your display to an awkward viewing angle.
- Avoid looking at bright light sources, such as open windows, for extended periods of time.

Developing good work habits

Develop the following work habits to make your computer use more relaxing and productive:

- Take short breaks regularly and often.
- Perform some stretching exercises.
- Breathe fresh air as often as possible.
- Exercise regularly and maintain a healthy body.



Warning! We do not recommend using the product on a couch or bed. If this is unavoidable, work for only short periods, take breaks regularly, and do some stretching exercises.



For more information and help in recycling, please visit the following websites:
Worldwide: <http://www.acer-group.com/public/Sustainability/sustainability01.htm>

UNPACKING

Please check the following items are present when you unpack the box, and save the packing materials in case you will need to ship or transport the monitor in future.

- LCD Monitor

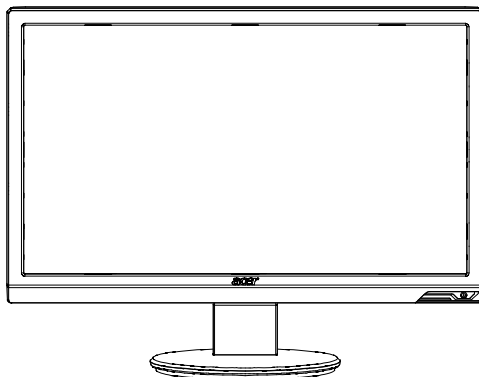

- AC Power Cord

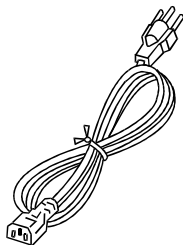

- D-Sub Cable

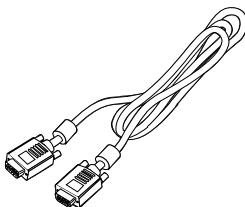

- DVI Cable
(Only Dual-Input Model)

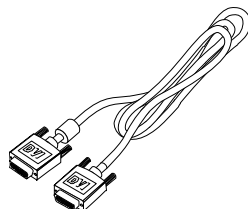

- Audio Cable
(Only Audio-Input Model)
(Optional)

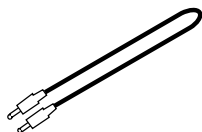

- User Manual



- Quick Start Guide



Attaching / Removing the Base



Note: Remove the monitor and monitor base from its packaging. Carefully place the monitor face-down on a stable surface -- use a cloth to avoid scratching the screen.

Install:

Align the base with the stand and push the base towards the top of the monitor.

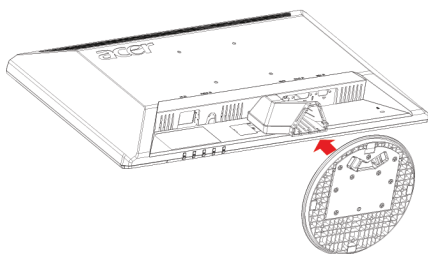

Remove:

Depress the release hooks as indicated first before removing the base and follow the arrow direction to remove it.

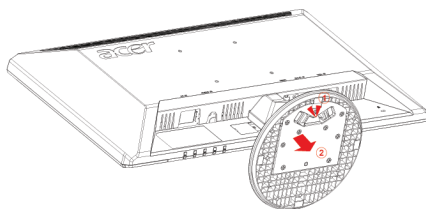

SCREEN POSITION ADJUSTMENT

In order to optimize the best viewing position, you can adjust the tilt of the monitor by using both of your hands to hold the edges of the monitor as shown in the figure below.

The monitor can be adjusted to 15 degrees up or 5 degrees down as indicated by arrow below.

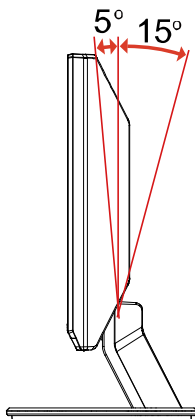

CONNECTING THE POWER CORD

- Check first to make sure that the power cord you use is the correct type required for your area.
- This monitor has a universal power supply that allows operation in either 100/120V AC or 220/240 V AC voltage area. No user-adjustment is required.
- Plug one end of the power cord to the AC Inlet, plug another end to a proper AC outlet.
- For unit using at 120 V AC:
Use a UL Listed Cord Set, Type SVT wire and plug rated 10 A/125 V.
- For unit using at 220/240 V AC (outside of U.S.):
Use a Cord Set consisting of H05VV-F cord and plug rated 10 A, 250 V. The cord set should have the appropriate safety approvals for the country in which the equipment will be installed.

SAFETY PRECAUTION

- Avoid placing the monitor, or any other heavy object, on the power cord to avoid damage to the cable.
- Do not expose the monitor to rain, excessive moisture, or dust.
- Do not cover the ventilation slots or openings of the monitor. Always put the monitor in a place where there is adequate ventilation.
- Avoid placing the monitor against a bright background or where sunlight or other light sources may reflect on the face of the monitor. Place the monitor just below eye level.
- Handle with care when transporting the monitor.
- Refrain from giving shock or scratch to the screen, as screen is fragile.

CLEANING YOUR MONITOR

Please carefully follow the below guidelines when cleaning the monitor.

- Always unplug the monitor before cleaning.
- Use a soft cloth to wipe the screen and cabinet front and sides.

Power saving

The monitor will be driven into Power Saving" mode by the control signal from the display controller, as indicated by the amber-color power LED.

State	LED Light
ON	Blue
Power Saving Mode	Amber

The power saving states will be kept until a control signal has been detected or the keyboard or mouse is activated. The recovery time from Active OFF state back to ON state is around 3 seconds.

DDC

To make your installation easier, the monitor is able to Plug and Play with your system if your system also supports DDC protocol. The DDC (Display Data Channel) is a communication protocol through which the monitor automatically informs the host system about its capabilities, for example, supported resolutions and corresponding timing. The monitor supports DDC2B standard.

CONNECTOR PIN ASSIGNMENT

15-Pin Color Display Signal Cable

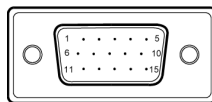

PIN NO.	DESCRIPTION	PIN NO.	DESCRIPTION
1.	Red	9.	+5V
2.	Green	10.	Logic Ground
3.	Blue	11.	Monitor Ground
4.	Monitor Ground	12.	DDC-Serial Data
5.	DDC-return	13.	H-Sync
6.	R-Ground	14.	V-Sync
7.	G-Ground	15.	DDC-Serial Clock
8.	B-Ground		

19-pin color display signal cable*

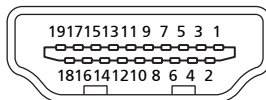

PIN No.	Description	PIN No.	Description
1	TMDS Data2+	2	TMDS Data2 Shield
3	TMDS Data2-	4	TMDS Data1+
5	TMDS Data1 Shield	6	TMDS Data1-
7	TMDS Data0+	8	TMDS Data0 Shield
9	TMDS Data0-	10	TMDS Clock+
11	TMDS Clock Shield	12	TMDS Clock-
13	CEC	14	Reserved (N.C. on device)
15	SCL	16	SDA
17	DDC/CEC Ground	18	+5V Power
19	Hot Plug Detect		

* only for certain models

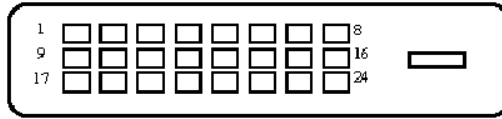

24-Pin Color Display Signal Cable*

PIN	Meaning	PIN	Meaning
1.	TMDS Data2-	13.	NC
2.	TMDS Data2+	14.	+5V Power
3.	TMDS Data 2/4 Shield	15.	Logic Ground
4.	NC	16.	Hot Plug Detect
5.	NC	17.	TMDS Data0-
6.	DDC Clock	18.	TMDS Data0+
7.	DDC Data	19.	TMDS Data 0/5 Shield
8.	NC	20.	NC
9.	TMDS Data1-	21.	NC
10.	TMDS Data1+	22.	TMDS Clock Shield
11.	TMDS Data 1/3 Shield	23.	TMDS Clock+
12.	NC	24.	DDC TMDS Clock-

Standard Timing Table

Mode	Resolution			
1	VGA	640x480	60	Hz
2	MAC	640x480	66.66	Hz
3	VESA	720x400	70	Hz
4	SVGA	800x600	56	Hz
5	SVGA	800x600	60	Hz
6	XGA	1024x768	60	Hz
7	XGA	1024x768	70	Hz
8	VESA	1152x864	75	Hz
9	SXGA	1280x1024	60	Hz
10	WXGA	1280x800	60	Hz
11	WXGA+	1440x900	60	Hz
12	UXGA	1920x1080	60	Hz

INSTALLATION

To install the monitor to your host system, please follow the steps as given below:

Steps

1. 1-1 Connect Video Cable
 - a. Make sure both the monitor and computer are powered-OFF.
 - b. Connect the VGA video cable to the computer.
- 1-2 Digital Cable (Only Dual-Input Model)
 - a. Make sure both the monitor and computer are powered-OFF.
 - b. Connect one end of the 24-pin DVI cable to the back of the monitor and connect the other end to the computer's port.
2. Connect the Audio Cable(Only Audio-Input Model)(Optional)
3. Connect power cord

Connect the power cord to the monitor, then to a properly grounded AC outlet.
4. Power-ON Monitor and Computer

Power-ON the monitor first, then power-ON the computer.
This sequence is very important.
5. If the monitor still does not function properly, please refer to the troubleshooting section to diagnose the problem.

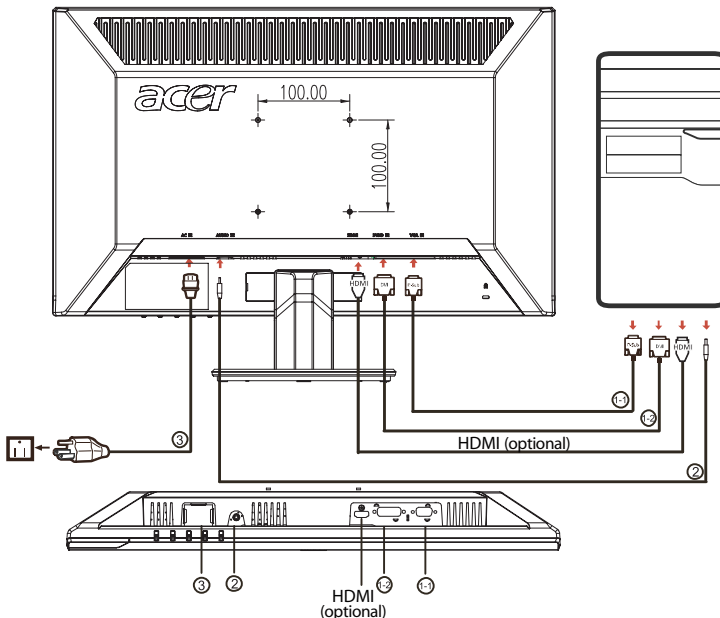

USER CONTROLS

⏻ Power Switch / Power LED:
To turn the monitor ON or OFF.
Lights up to indicate the power is turned ON.

Using the Shortcut Menu

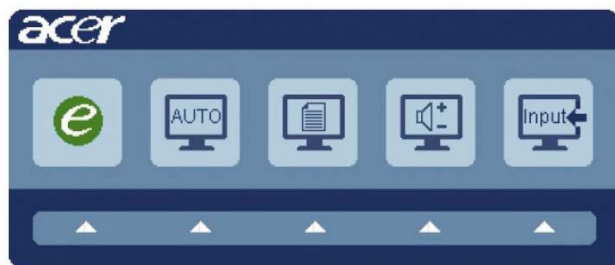

Press the function button to open the shortcut menu. The shortcut menu lets you quickly select the most commonly accessed settings.

e Empowering:
Press the Empowering Key to open the Acer eColor Management OSD and access the scenario modes.

AUTO Auto Adjust:
Press this button to activate the Auto Adjustment function. The Auto Adjustment function is used to set the HPos, VPos, Clock and Focus.

MENU OSD functions
Press this button to activate the OSD menu.

Volume Up / Down
Press to adjust volume (Only Audio-Input Model)(Optional)

INPUT Input Key
Use Input key to select from different video sources that may be connected to your monitor.

(a) VGA input (b) DVI input (c) HDMI input
As you cycle through the sources you will see the following messages on right top side of screen to indicate currently selected input source. It may take 1 or 2 seconds for the image to appear.

VGA or DVI or HDMI

If either VGA or DVI input is selected, but the VGA and DVI cables are not connected, a floating dialog box indicates:

"No Cable Connect" or "No Signal"

Acer eColor Management



Operation instructions

Step 1: Press " *e* " Key to open the Acer eColor Management OSD and access the scenario modes

Step 2: Press " ◀ " or " ▶ " to select the mode

Step 3: Press " AUTO " Key to confirm the mode and exit the eColor menu.

Features and Benefits

Main Menu icon	Sub Menu icon	Sub Menu item	Description
	N/A	User mode	User defined. Settings can be fine-tuned to suit any situation
	N/A	Text mode	Optimal balance of brightness and contrast prevent eyestrain. The most comfortable way to read onscreen text
	N/A	Standard mode	Default Setting. Reflects native display capability
	N/A	Graphic mode	Enhances colors and emphasize fine detail. Pictures and photographs appear in vibrant colors with sharp detail.
	N/A	Movie mode	Displays scenes in clearest detail. Presents great visuals, even in unsuitably-lit environments.

Adjusting the OSD settings



Note: The following content is for general reference only. Actual product specifications may vary.

The OSD can be used for adjusting the settings of your LCD Monitor. Press the MENU key to open the OSD. You can use the OSD to adjust the picture quality, OSD position and general settings. For advanced settings, please refer to following page:

Adjusting the picture quality

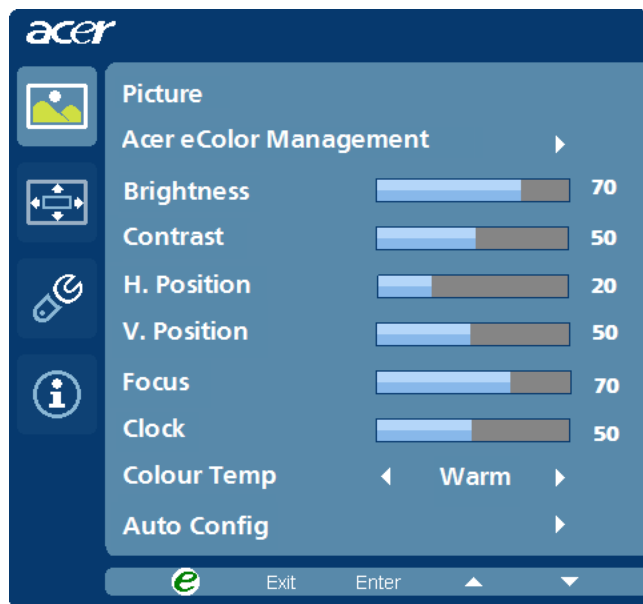

- 1 Press the MENU key to bring up the OSD.
- 2 Using the ◀/▶ keys, select  Picture from the OSD. Then navigate to the picture element you wish to adjust.
- 3 Use the ◀/▶ keys to adjust the sliding scales.
- 4 The Picture menu can be used to adjust the current Brightness, Contrast, Colour Temp, Auto Config and other image-related qualities.

Adjusting the OSD position



- 1 Press the MENU key to bring up the OSD.
- 2 Using the directional keys, select  OSD from the on screen display. Then navigate to the feature you wish to adjust.

Adjusting the setting

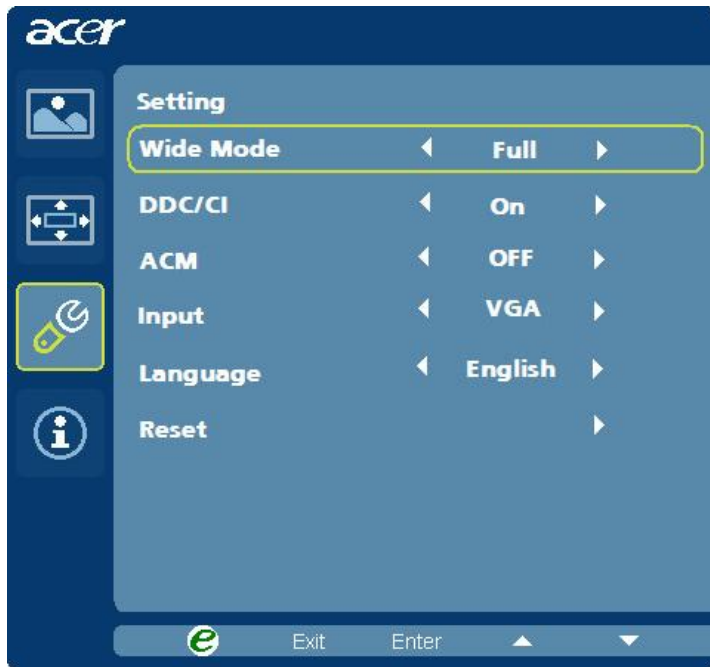

- 1 Press the MENU key to bring up the OSD.
- 2 Using the ◀/▶ keys, select  Setting from the OSD. Then navigate to the feature you wish to adjust.
- 3 The Setting menu can be used to adjust the screen Menu Language and other important settings.

Product information



- 1 Press the MENU key to bring up the OSD.
- 2 Using the ◀/▶ keys, select **i** Information from the OSD. Then the basic information of LCD monitor will show up for current input.

TROUBLESHOOTING

Before sending your LCD monitor for servicing, please check the troubleshooting list below to see if you can self-diagnose the problem.

(VGA Mode)

Problems	Current Status	Remedy
No Picture	LED ON	<ul style="list-style-type: none"> Using OSD, adjust brightness and contrast to maximum or reset to their default settings.
	LED OFF	<ul style="list-style-type: none"> Check the power switch.
		<ul style="list-style-type: none"> Check if AC power cord is properly connected to the monitor.
	LED displays amber color	<ul style="list-style-type: none"> Check if video signal cable is properly connected at the back of monitor.
<ul style="list-style-type: none"> Check if the power of computer system is ON. 		
Abnormal Picture	Unstable Picture	<ul style="list-style-type: none"> Check if the specification of graphics adapter and monitor is in compliance which may be causing the input signal frequency mismatch.
	Display is missing, center shift, or too small or too large in display size	<ul style="list-style-type: none"> Using OSD, adjust RESOLUTION, CLOCK, CLOCK-PHASE, H-POSITION and V-POSITION with non-standard signals.
		<ul style="list-style-type: none"> Using OSD, in case of missing full-screen image, please select other resolution or other vertical refresh timing.
		<ul style="list-style-type: none"> Wait for a few seconds after adjusting the size of the image before changing or disconnecting the signal cable or powering OFF the monitor.
Abnormal Sound (Only Audio-Input model) (Optional)	No sound, or sound level is too low	<ul style="list-style-type: none"> Check the audio cable with the host PC is connected.
		<ul style="list-style-type: none"> Check if the volume setup of the host PC is in minimum position and try to raise the volume level.

(DVI Mode)

Problems	Current Status	Remedy
No Picture	LED ON	· Using OSD, adjust brightness and contrast to maximum or reset to their default settings.
	LED OFF	· Check the power switch.
		· Check if AC power cord is properly connected to the monitor.
LED displays amber color	· Check if video signal cable is properly connected at the back of monitor.	
	· Check if the power of computer system is ON.	
Abnormal Sound (Only Audio-Input model) (Optional)	No sound, or sound level is too low	· Check the audio cable with the host PC is connected.
		· Check if the volume setup of the host PC is in minimum position and try to raise the volume level.



ENERGY STAR®

Acer's ENERGY STAR qualified products save you money by reducing energy costs and helps protect the environment without sacrificing features or performance. Acer is proud to offer our customers products with the ENERGY STAR mark.

What is ENERGY STAR?

Products that are ENERGY STAR qualified use less energy and prevent greenhouse gas emissions by meeting strict energy efficiency guidelines set by the U.S. Environmental Protection Agency. Acer is committed to offer products and services worldwide that help customers save money, conserve energy and improve the quality of our environment. The more energy we can save through energy efficiency, the more we reduce greenhouse gases and the risks of climate change. More information refers to

<http://www.energystar.gov> or <http://www.energystar.gov/powermanagement>

Acer ENERGY STAR qualified products:

- Produce less heat and reduce cooling loads, and warmer climates.
- Automatically go into “display sleep” and “computer sleep” mode after 15 and 30 minute of inactivity respectively.
- Wake the monitor when it is in Active Off mode , move the mouse or press any keyboard key.
- Computers will save more than 80% energy at “sleep” mode.

ENERGY STAR and the ENERGY STAR mark are registered U.S. marks

Acer Incorporated
8F, 88, Sec. 1, Hsin Tai Wu Rd., Hsichih
Taipei Hsien 221, Taiwan



Declaration of Conformity

We,

Acer Incorporated

8F, 88, Sec. 1, Hsin Tai Wu Rd., Hsichih, Taipei Hsien 221, Taiwan

Contact Person: Mr. Easy Lai

Tel: 886-2-8691-3089 Fax: 886-2-8691-3120

E-mail: easy_lai@acer.com.tw

Hereby declare that:

Product: 23" W LCD Monitor
Trade Name: Acer or eMachines or Gateway or packard bell
Model Number: P235H
SKU Number: P235H xxx ("x" = 0~9, a ~ z, A ~ Z or Blank)

Is compliant with the essential requirements and other relevant provisions of the following EC directives, and that all the necessary steps have been taken and are in force to assure that production units of the same product will continue comply with the requirements.

EMC Directive 2004/108/EC as attested by conformity with the following harmonized standards:

- EN55022:2006, AS/NZS CISPR22:2006, Class B
- EN55024:1998 + A1:2001 + A2:2003
- EN61000-3-2:2006, Class D
- EN61000-3-3:1995 + A1:2001+A2: 2005

Low Voltage Directive 2006/95/EC as attested by conformity with the following harmonized standard:

- EN60950-1:2001 + A11:2004

RoHS Directive 2002/95/EC on the Restriction of the Use of certain Hazardous Substances in Electrical and Electronic Equipment

Year to begin affixing CE marking 2009.

Easy Lai

Easy Lai/Manager
Regulation, Acer Inc.

Feb. 27, 2009 -
Date



Federal Communications Commission Declaration of Conformity

This device complies with Part 15 of the FCC Rules. Operation is subject to the following two conditions: (1) this device may not cause harmful interference, and (2) this device must accept any interference received, including interference that may cause undesired operation.

The following local Manufacturer /Importer is responsible for this declaration:

Product Name:	23" W LCD Monitor
Main Model Number:	P235Hxxxx
Series Model Number:	P235Hxxxx
Name of Responsible Party:	Acer America Corporation
Address of Responsible Party:	333 West San Carlos St. San Jose, CA 95110 U. S. A.
Contact Person:	Acer Representative
Phone No.:	254-298-4000
Fax No.:	254-298-4147