

# Acer LCD Display Quick Start Guide

## Important

**Note:** This product can only operate with the attached power accessories.

Before installing your LCD display, consider the following with reference to the conditions under which the display is to be installed:

- ◆ Make sure that the voltage of the product conforms to the local voltage.
- ◆ Don't allow children to operate the product alone.
- ◆ For more information about safety, read the manual in the attached CD-ROM.
- ◆ To minimize the reflection of the display, protect your eyes and ensure the premium quality, don't install your LCD display near windows or with backlight. Keep the display away from your eyes by at least 30 cm.
- ◆ The upper edge of the display should be a little higher than your sight.
- ◆ Adjust the front and back angles of the display based on your visual angle so that you can view the display comfortably.

## Components and Accessories

LCD Display  
(with speakers)

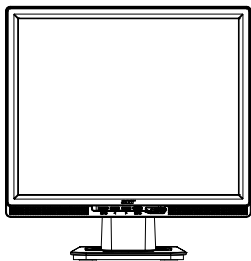

D-Sub Signal Cable

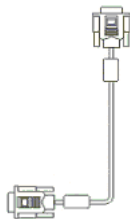

DVI Signal Cable  
(Optional)

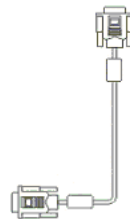

Quick Start Guide



Power Cable

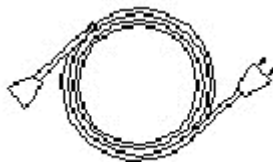

Audio Cable



User's Manual (CD-ROM)



## Installation Guide

### Quick Installation

**Note:** Read the [Important] section carefully before starting the installation

Complete the following steps for quick installation: (See the figure)

#### Assemble the seat of the display

- Take out the seat out of the box and place it on a flat table.
- Take your LCD display out of the carton and assemble the display and seat along the rail. You will hear a click sound when the display and seat are engaged correctly.

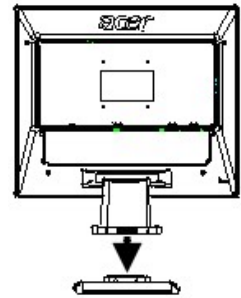

#### Connection to PC

- Make sure that the power supply of your PC is turned off and the power plug is removed.
- Connect and fasten both ends of the signal cable to your PC host and LCD display respectively.
- If your LCD display has built-in speakers, connect the audio cable attached to the display from the sound card output of your PC to the audio input on the back of your LCD display.
- Connect the attached power cable to your LCD display.
- Plug the power cable to the receptacle.
- Turn on the power supplies of your PC and LCD display.

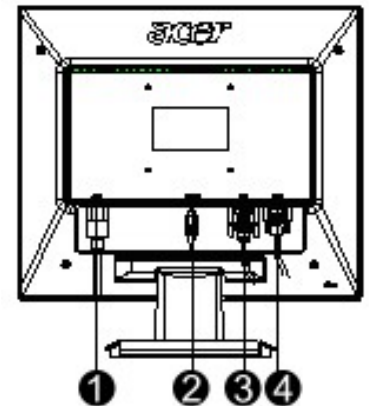

- ❶ Power Cable
- ❷ Audio Cable
- ❸ DVI Signal Cable (Optional)
- ❹ D-Sub Signal Cable

## Adjustment of Display

### Key Definition

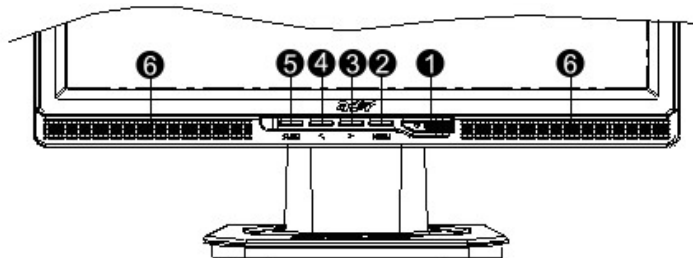

1		Power Source	Power On/Off Green indication: Power is on and normal Orange indication: Sleep status in the energy-saving mode Colorless indication: Power off
2	Menu	OSD Menu	Press this button to enter OSD. Press it again to exit OSD.
3	>	Plus	Press this button for selection or adjustment when OSD is started.
4	<	Minus	Press this button and click < and > to adjust volume when OSD is not started (for the model with speakers only)
5	Auto	Automatic Adjustment	Press this button to exit the manual when OSD is started. Press this button for the display to optimize the position, phase and clock pulse automatically when OSD is not started.
6	Speaker	(For the model with speakers)	