

Table of Contents

Precautions	2
Special notes on LCD monitors.....	2
Package contents	3
Installation instructions	3
Assembling the monitor	3
Adjusting the viewing angle	4
Connecting the devices	6
Switching the power	6
Adjusting display settings.....	7
External controls.....	7
OSD options.....	8
OSD menu	8
Troubleshooting.....	11
General specifications	12

Precautions



- The monitor may be damaged if placed too near a source of heat. Be aware of the location of radiators, cookers, open fires, etc.
- Do not cover the slots and openings on the back or top of the cabinet, as the monitor requires ventilation. The monitor should be located in a well-ventilated room to prevent the possibility of overheating.
- Do not allow sharp objects such as knives, pens, or pencils near the screen. If such objects touch the screen, the LCD panel may be permanently scratched.
- When cleaning this monitor, disconnect it from the electrical socket to avoid any danger of electrocution. A soft, lint-free cloth should be used to clean the outside of the monitor. A cloth slightly moistened with a mild detergent solution will clean stubborn stains. Keep liquids away from the display screen, including sprays. Do not spray liquid directly on the monitor — it is best to lightly spray on to a cloth and then gently wipe the monitor. If liquid gets inside the monitor it can cause electrical shock and/or damage to the unit.
- If you encounter a problem, please check the "Troubleshooting" section first. If this does not resolve the problem, do not attempt to repair the monitor by yourself. Opening or removing covers can lead to injury or death through electrocution or other hazards. Please contact a qualified engineer if the troubleshooting section does not solve your problem.

Recycling information

Acer cares very much about protecting the environment, and firmly believes that the environment will be healthier if appropriate measures are taken to treat and recycle industrial technology products. Such products contain hazardous, poisonous substances that can seriously harm the environment. Furthermore, industrial technology products contain materials that can be recycled and re-integrated. We strongly encourage you to recycle this IT product through the appropriate agency by reviewing the information provided below:

United States: <http://www.ciwmb.ca.gov/electronics/act2003/Recovery/Approved/>

Asia: http://recycle.epa.gov.tw/public/public4_2.htm

Europe: EL-Kretsen: <http://www.el-kretsen.se/>

EL-retur: <http://www.elretur.no/>

SWICO: <http://swico.one.webbuild.ch/>

Special notes on LCD monitors

The following symptoms are normal for LCD monitors and do not indicate a problem with the device:

- Due to the nature of the fluorescent light, the screen may flicker during initial use. Turn off the power switch and then turn it on again to make the flicker disappear.
- You may find slightly uneven brightness on the screen depending on the desktop pattern you use.
- The LCD screen has effective pixels of 99.99% or more. It may include blemishes of 0.01% or less (caused by a missing pixel or a pixel that is always lit).
- When the same image is displayed for hours on end, its afterimage may remain after switching to a new image. When this happens, the screen will recover slowly by changing the image. Turning the LCD monitor off for several hours will also correct this problem.

Package contents

LCD monitor

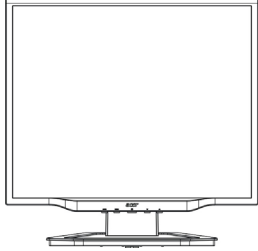

Power cord



Audio cable



VGA cable



DVI cable

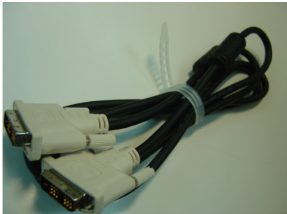

User's Guide (CD)



Quick Start Guide

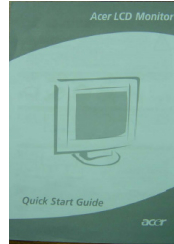

Installation instructions

Assembling the monitor

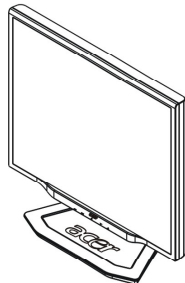

1. Position the monitor on top of the base.

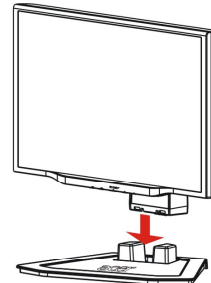

2. Connect the base into the neck of the monitor along the track.

Detaching the monitor

If you need to detach the monitor for repackaging, the monitor and base must be separated in order to fit in the carton.

To detach the monitor:

1. Unplug the AC power cord to make sure the power is off.
2. Pull the 4 hooks on the bottom side of the base and hold.
3. Separate the monitor and base.



Important

When separating the monitor and base, find a clean, flat surface to place the monitor on and place a clean dry cloth under the monitor to protect it further. After removing the monitor from the base, pull the monitor slightly up and away from the base and place it on the cloth.

Adjusting the viewing angle

The viewing angle of the monitor ranges from -5° – 20° .

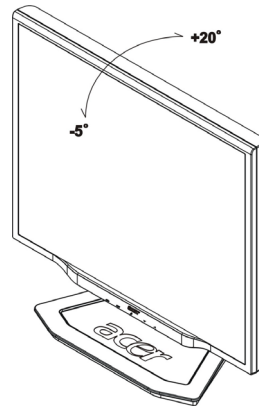

Adjusting the viewing angle (Only AL1723 h/AL1723 r)

Your monitor features a multi-adjustable stand that will enable it move 100mm up/down (height adjustment), 25 degree forward/backward (tilt adjustment), 60 degree side/side (swivel adjustment). To make an adjustment, grasp the monitor with both hands on the right and left edge of the casing and move it to the desired position.

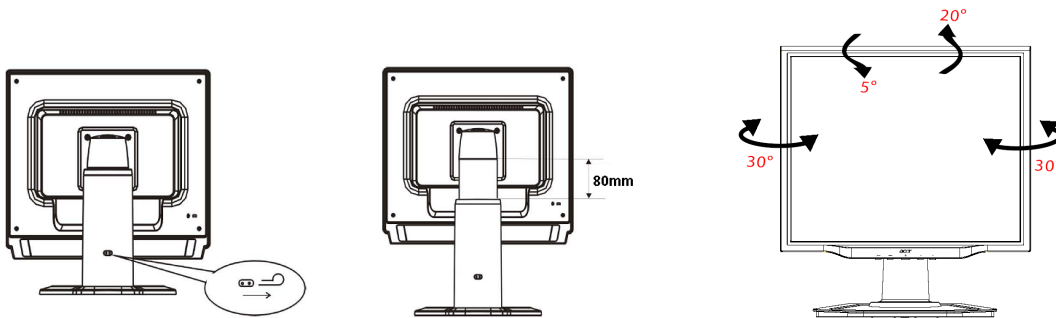

 Do not perform a pulling or plugging action when the display is under slanting status to prevent the display from ejecting.

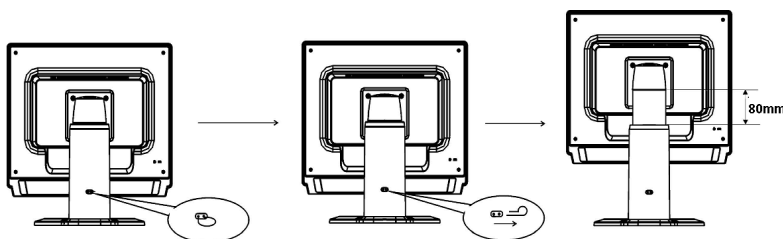
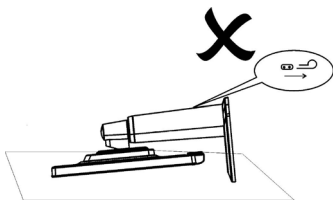

Pull out the pin from the display support frame as per the figure and then adjust the height. Note that upon pulling out the pin, erect the machine on the table to prevent the top part of the display from ejecting.

Rotate Adjustment (Only AL1723 r):

1. Before adjusting the height, be sure to pull out the pin indicated in the figure. as per Fig. 1.
2. To rotate the screen, set the screen position to the highest height, as per Fig. 2.
3. Hold the left and right sides of screen with both hands and then turn 90 degrees in clockwise direction. as per Fig. 3.
4. After rotation is complete, adjust the screen height to suit your own position. as per Fig. 4.
5. To return to original position, turn 90 degrees in counter clockwise direction. as per Fig. 5.
6. After rotation is complete, adjust the screen height to suit your own position. as per Fig. 6.

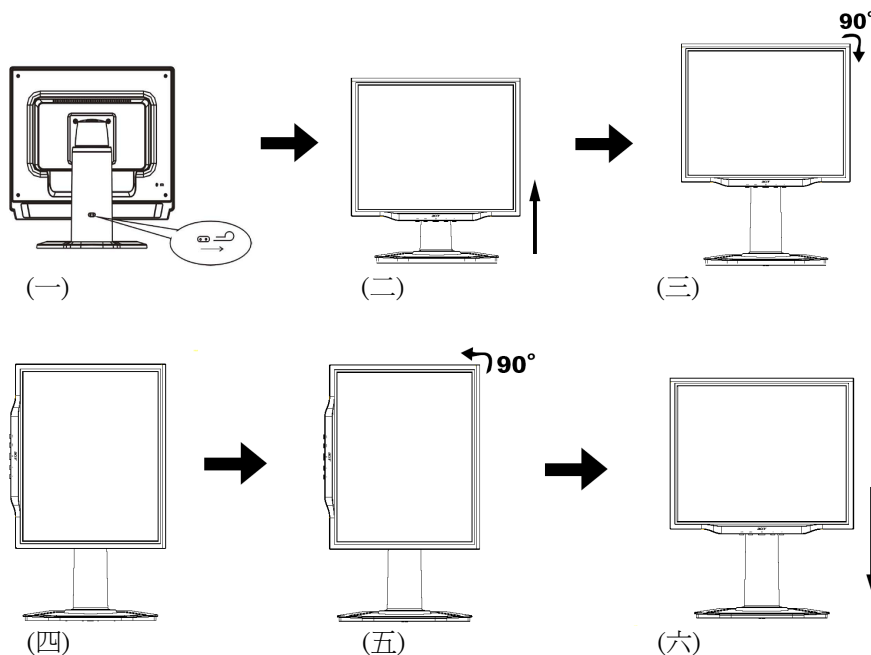

- **In order to use the Pivot function, the included Pivot Software must be installed.**

© Portrait Displays, Inc. All rights reserved.

NOTES

- Do not touch the LCD screen when you change the angle. It may cause damage or break the LCD screen.
- Careful attention is required not to catch your fingers or hands when you change the angle.

Connecting the devices



Caution: Make sure that the computer and the monitor are both disconnected from the power supply.

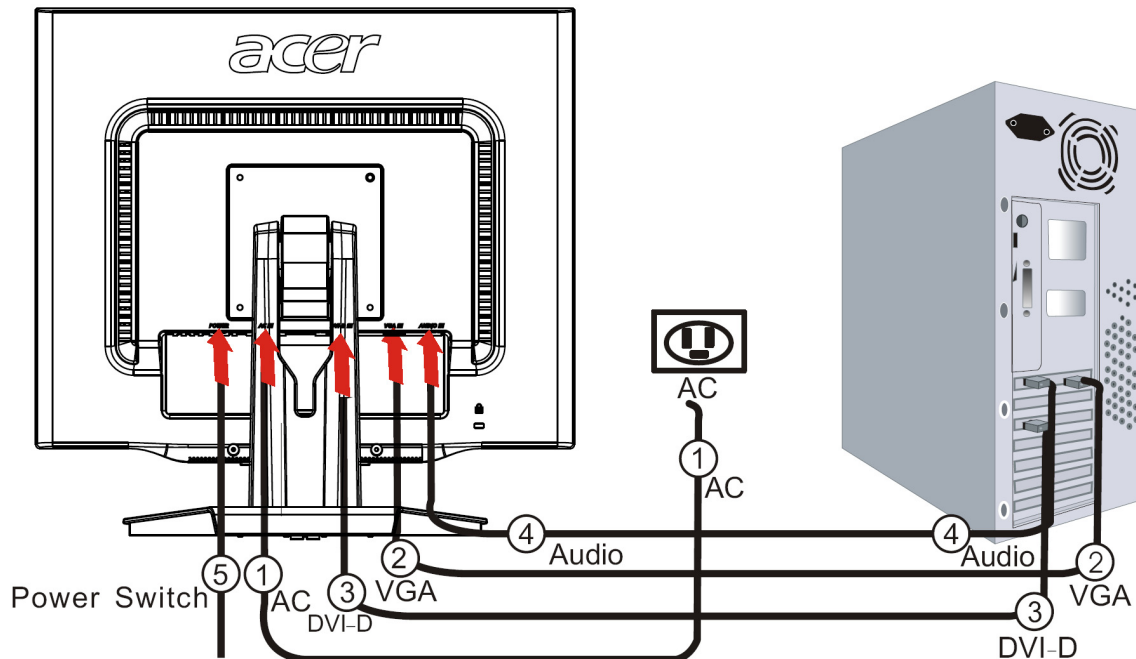

1	Power cord	Attach the monitor to the power cord, and then insert the power cord into a properly grounded electrical socket.
2	VGA cable	Connect the signal cable to the VGA input socket of the monitor, and connect the signal cable to the VGA output socket of the graphics card on the computer. Then tighten the thumbscrews on the connector.
3	DVI-D cable	Connect the signal cable to the DVI-D input socket of the monitor, and connect the signal cable to the DVI-D output socket of the graphics card on the computer. Then tighten the thumbscrews on the connector.
4	Audio cable	Connect the audio input socket (AUDIO IN) of the LCD monitor and the computer by means of the audio cable.
5	Power switch	On / off



WARNING!

Check the VGA card of your computer. Make sure the shape of the plug matches the shape of the socket it is inserted into. Also check that none of the pins are bent or otherwise damaged.

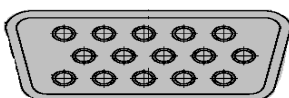

VGA



DVI-D

Switching the power

First, switch on the hard-switch on the backside of monitor, then turn on PC and power button on monitor's control panel. When you see the LED on the power button go green, this indicates the computer is ready for use. Allow about 10 seconds for the video signal to appear. If you do not see the green light on the power button or a video signal, check the connections.

Adjusting display settings

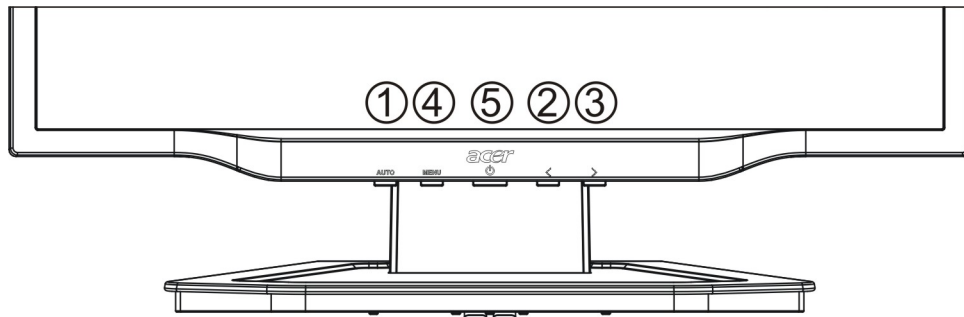

External controls

1	AUTO	Auto	If the OSD is active, press Auto to exit a selection in the OSD. If the OSD is inactive, press Auto and the monitor will automatically optimize the position, focus, and clock of your display.
2/3	</>	Minus / Plus	If the OSD is active, press Minus or Plus to toggle between the OSD options. If OSD is inactive, press Minus or Plus to adjust the volume.
4	MENU	OSD functions	Press to view the OSD. Press again to enter a selection in the OSD.
5		Power	Power on/off Green: power on Orange: in sleep mode

OSD options

Please refer to "External controls" on Page 7.

To adjust the OSD settings:

1. Press the **Menu** button to open the OSD menu.
2. Use **Plus/Minus** buttons to toggle between the 10 OSD functions (and also to adjust the controls to desired levels once a function has been selected).
3. Press **Menu** again to select one of the 10 OSD functions.
4. When you have finished adjusting the OSD settings, press the **Auto** button to exit the OSD.

OSD menu



Contrast:

This adjusts dark and light shades of color relative to each other.

Brightness:

This adjusts the brightness of the picture on the screen.

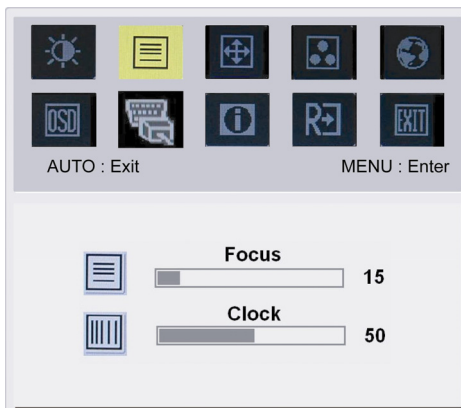

Focus:

This removes any horizontal distortion and makes the picture clear and sharp.

Clock:

If there are any vertical stripes seen on the background of the screen, this renders them less noticeable by minimizing their size. It also changes the size of the horizontal screen.

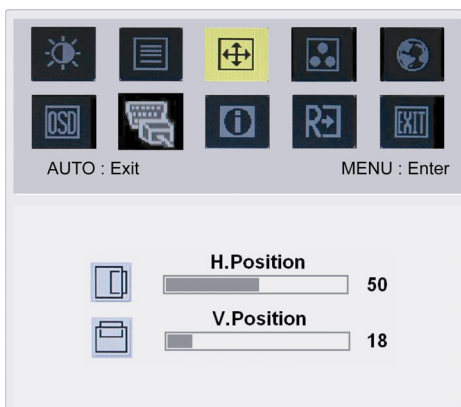

H-Position:

This adjusts the horizontal.

V-Position:

This adjusts the vertical.

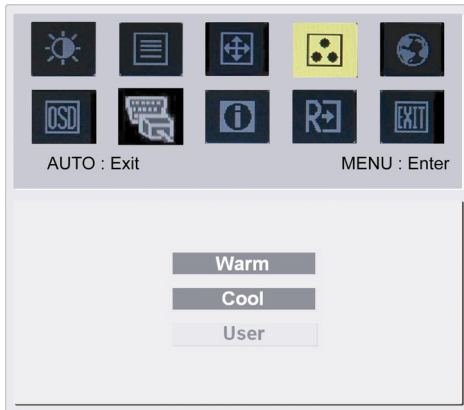

Color adjustment:

There are three ways to adjust color:

Warm (reddish white)

Cool (bluish white)

User (you can adjust the colors red, green and blue to the intensity you desire)



Language for Asia:

Select the OSD menu language. Select from English, German, Spanish, Simplified Chinese, Traditional Chinese, French, Italian, and Japanese.

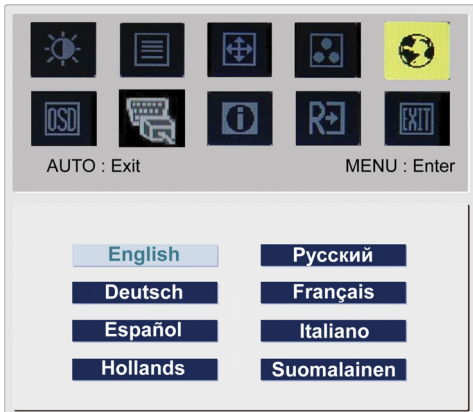

Language for EMEA:

Select the OSD menu language. Select from English, German, Spanish, Russia, Netherlands, French, Italian, and Finnish.



OSD Settings:

This changes the position of the OSD window on the screen and the staying time.

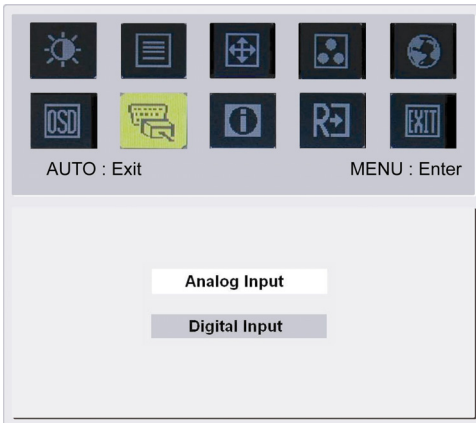

Input signal:
Select either **Analog Input** or **Digital Input** video.

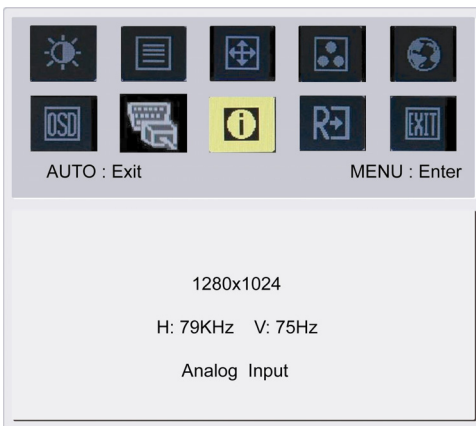

Information:
This shows information about the screen.

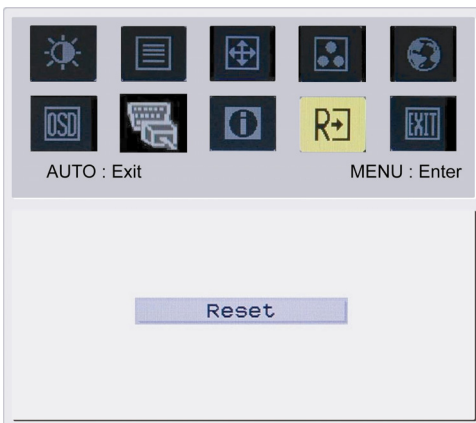

Reset:
Resets all settings to default levels.

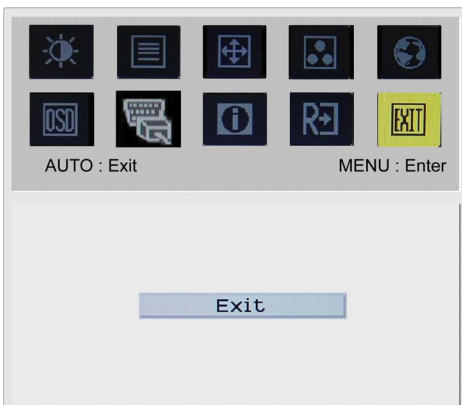

Exit:
Exit from OSD.

Troubleshooting

Problem	Possible Solutions
Power LED is not ON	<ul style="list-style-type: none"> • Check to see if the power switch is in the ON position. • Ensure that the Power Cord is connected.
No picture	<ul style="list-style-type: none"> • Check to see if the power switch is in the ON position. • Ensure that the power cord is connected. • Ensure the video cable is securely connected to the back of the monitor and the computer. • Move the mouse or press any key on the keyboard to bring the monitor out of "active off" mode.
Picture shows inappropriate colors	<ul style="list-style-type: none"> • See color adjustment (p. 8) to adjust RGB color.
Picture bounces or a wave pattern is present in the picture	<ul style="list-style-type: none"> • Move or switch off electrical devices that may be causing interference. • Inspect the monitor's video cable and ensure that none of the pins are bent.
Image is not sized or centered properly	<ul style="list-style-type: none"> • Press select/auto key and the monitor will automatically optimize the position of your display. • See horizontal and vertical position adjustment (p. 7).



Caution: Do not attempt to service or open the monitor or computer yourself. Please refer all servicing to qualified service personnel if the "Troubleshooting" section cannot solve your problems.

General specifications

Item	Specification
LCD panel	
Display	17-inch flat panel active-matrix TFT LCD
Max resolution	SXGA 1280×1024 pixels
Pixel pitch	0.264 mm
Color	16.2 M
Brightness	300 cd/m ² (Typical)
Contrast ratio	800:1 (Typical)
Response time	8 ms (Typical)
View angle of horizontal	160°(Typical)
View angle of vertical	160°(Typical)
External controls	
Power Button	ON/OFF
Control Buttons	Auto, menu, minus, plus
OSD Function	
Contrast/Brightness	Contrast/Brightness
Focus/Clock	Focus/Clock
Position	Position
Color	Color
Language	Language
OSD setting	OSD Setting
Input signal	Input signal
Information	Information
Reset	Reset
Exit	Exit
Video Interface	
Video	Analog 0.7 V / Digital TMDS
Sync	TTL (+ / -)
Plug & Play	DDC2B
Power	
Power source	100 – 240 V AC, 50/60 Hz
Power consumption during normal operation	< 40 W
Power consumption during active off operation	< 2W
Dimension and weight	
Dimensions (W×H×D)	375.5 x 382 x 190 mm (with stand)
Weight (Net/Gross)	4.0kg / 5.5 kg
Dimensions (W×H×D)	375.5 x 413.5x 231.3 mm(with stand)(only AL1723 h/AL1723 r)
Weight (Net/Gross)	4.2 kg / 5.7 kg (only AL1723 h/AL1723 r)

Lamp disposal

Lamp(s) inside this product contain mercury and must be recycled or disposed of according to local, state or federal laws. For more information, contact the Electronic Industries Alliance at www.eiae.org. For lamp-specific disposal information, check www.lamprecycle.org.

