

Table of Contents

Safety Rules	1
Electrical Safety	1
Installation Safety	1
Cleaning Safety	1
SPECIAL NOTES ON LCD MONITORS	1
Components and Accessories	2
Usage	2
Installation Guide	2
Adjustment of Display	3
Operation	4
Adjustment of Screen	6
Attachment	6
Plug and Play	7
Power Saver	7
Troubleshooting	7
Technical Specifications	8
Display Mode	9

Safety Rules

Note: To ensure your safety and prolong the life of the product, read the following safety rules carefully when you use the product for the first time.

Electrical Safety

- ◆ DO NOT touch the inside of the display. Only authorized and qualified technicians are allowed to open the LCD display case.
- ◆ Only hold the plug, not the power cable, when you connect the plug to the receptacle. Make sure that your hands are dry without moisture.
- ◆ Don't expose your LCD display in the rain, water, or the environment with high temperature or humidity, such as kitchens, surroundings of a swimming pool, any place near flower vases, etc.)
- ◆ If your LCD display operates abnormally, especially if there is smoke, noise or smell, remove the plug immediately and contact our authorized dealer or service center.

Installation Safety

- ◆ Don't touch your LCD display with your fingers or any hard objects to avoid scratching or leaving any oil sludge on the surface of the display
- ◆ Install your LCD display at the place where the risk of dust contamination is low. Take moisture-proof and ventilation measures to protect your LCD display.
- ◆ Don't install your LCD display near any heat source, such as kitchen tables, ovens, or fire sources, or in the sun.
- ◆ Install your LCD at the place where children will not touch it to avoid electric shock, or dropping. Secure your LCD firmly or explain the safety rules to children, if required.
- ◆ When installing your LCD display or adjusting its angle, attention shall be paid to the loading capability and leveling of the display.

Cleaning Safety

- ◆ Don't spray or pour cleanser or water onto your LCD display or its case directly.
- ◆ When cleaning your LCD display, make sure that no liquid permeates into the inside of the LCD display or any accessory.
- ◆ Moisten a clean and soft lint-free cloth with water, ammonia-free water, or glass cleanser without alcohol, wring it dry and wipe the surface of your LCD display gently. It is recommended to use a silk cloth that is exclusively used to clean the display.

SPECIAL NOTES ON LCD MONITORS

The following symptoms are normal with LCD monitor and do not indicate a problem.

NOTES

- Due to the nature of the fluorescent light, the screen may flicker during initial use. Turn off the Power Switch and then turn it on again to make sure the flicker disappears.
- You may find slightly uneven brightness on the screen depending on the desktop pattern you use.
- The LCD screen has effective pixels of 99.99% or more. It may include blemishes of 0.01% or less such as a missing pixel or a pixel lit all of the time.
- Due to the nature of the LCD screen, an afterimage of the previous screen may remain after switching the image, when the same image is displayed for hours. In this case, the screen is recovered slowly by changing the image or turning off the Power Switch for hours.

Components and Accessories

LCD Display
(with speakers)



LCD Display
(without speakers)



D-Sub Signal Cable



DVI Signal Cable



(Optional)

Quick Start Guide



Power Cable

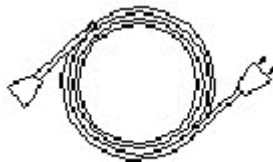

Audio Cable(with speakers)



Adaptor

(POTRANS: UP06511190
or DELTA: ADP-65MB B)



User's Manual (CD-ROM)



Usage

Installation Guide

Note: Read the [Safety Rules] section carefully before starting the installation

Attention

Before installing your LCD display, consider the following with reference to the space where the display is to be installed:

- ◆ To minimize the reflection of the display, protect your eyes and ensure premium quality, don't install your LCD display near windows or with backlight. Keep the display away from your eyes at least by 30 cm.
- ◆ The upper edge of the display should be a little higher than your sight.
- ◆ Adjust the front and back dip angles of the display based on your visual angle so that you can view the display comfortably.

Quick Installation

Complete the following steps for quick installation: (See the figure)

Assemble the seat of the display

- Take the seat out of the box and place it on a flat table.
- Take your LCD display out of the carton and assemble the display and seat along the rail. You will hear a click sound when the display and seat are engaged correctly.

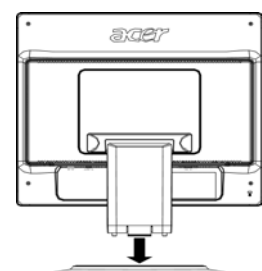

Connection to PC

- Make sure that the power supply of your PC is turned off and the power plug is removed.
- Connect and fasten both ends of the signal cable to your PC host and LCD display respectively.
- If your LCD display has built-in speakers, connect the audio cable attached to the display from the sound card output of your PC to the audio input on the back of your LCD display.
- Connect the attached power cable to your LCD display.
- Plug the power cable to the receptacle.
- Turn on the power supplies of your PC and LCD display.

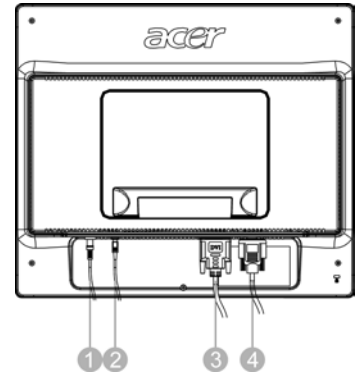

- ❶ Transformer DC end
- ❷ Audio Cable (Optional)
- ❸ DVI Signal Cable (Optional)
- ❹ D-Sub Signal Cable

Adjustment of Display

Key Definition

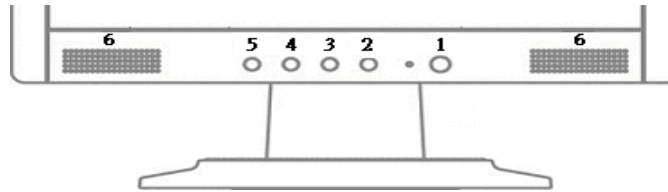

1		Power Source	Power On/Off Green indication: Power is on and normal Orange indication: Sleep status in the energy-saving mode Colorless indication: Power off
2.	Menu	OSD Menu	Press this button to enter OSD. Press it again to exit OSD.
3	>	Plus	Press this button for selection or adjustment when OSD is shown. Press this button and click < and > to adjust volume when OSD is not shown (for the model with speakers only)
4	<	Minus	
5	Auto	Automatic Adjustment	Press this button to exit the manual when OSD is shown. Press this button for the display to optimize the position, phase and clock pulse automatically when OSD is not shown.
6	Speaker	(For the model with speakers)	

Operation for Analog

Your LCD display has been adjusted to its optimal status before shipment. (See Page 9).
You can also adjust the image in accordance with the following illustrations and steps.

Steps:

1. Click MENU to display the OSD window as shown in the following figure.
2. Click < or > to select the function to be adjusted as shown in the following figure.
3. Click the MENU to select the function to be adjusted.
4. Click < or > to change current settings.
5. To exit OSD, select "EXIT" to close the OSD window and save changes. To change other settings, repeat steps 2-4.

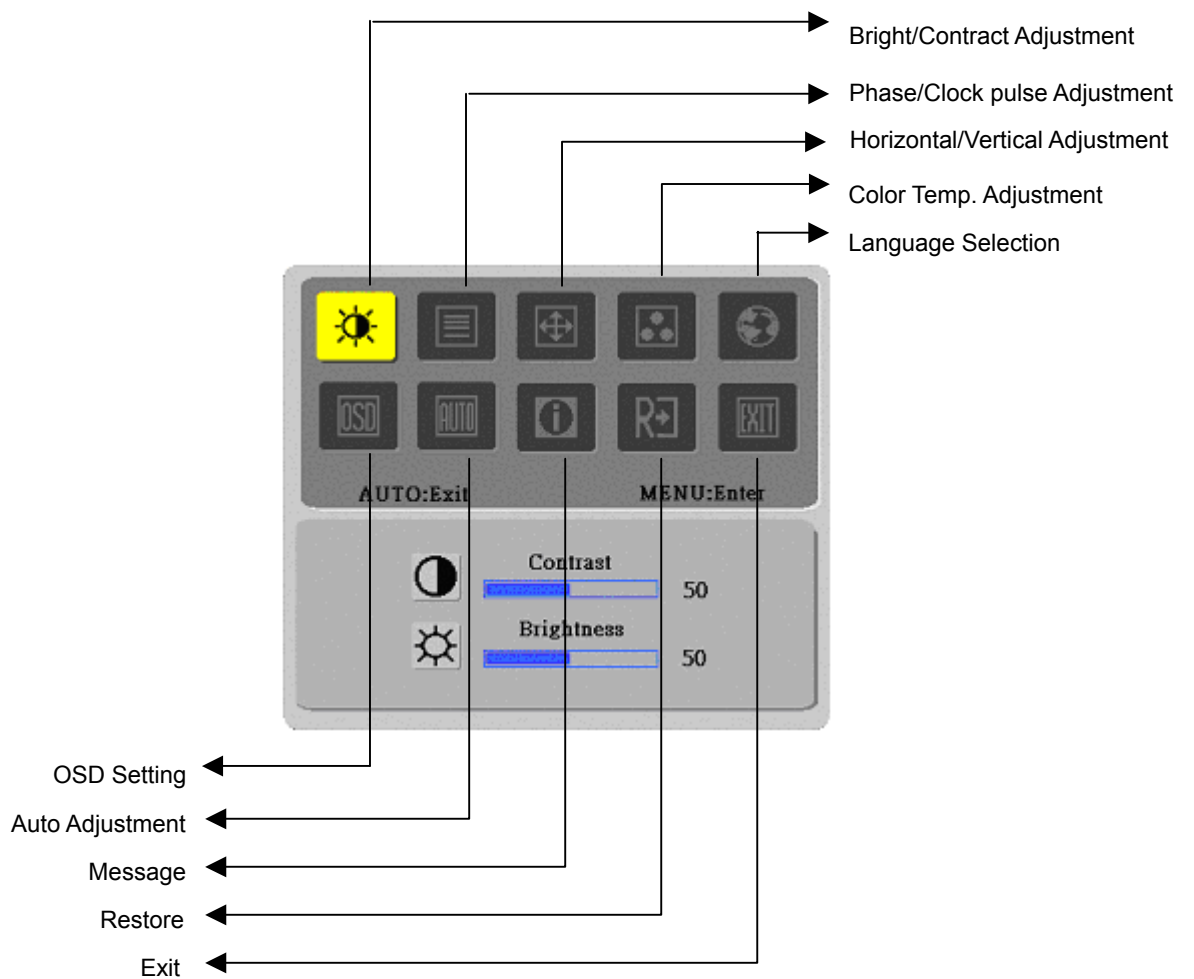

(Analog)

Operation for Digital

Your LCD display has been adjusted to its optimal status before shipment. (See Page 9).

You can also adjust the image in accordance with the following illustrations and steps.





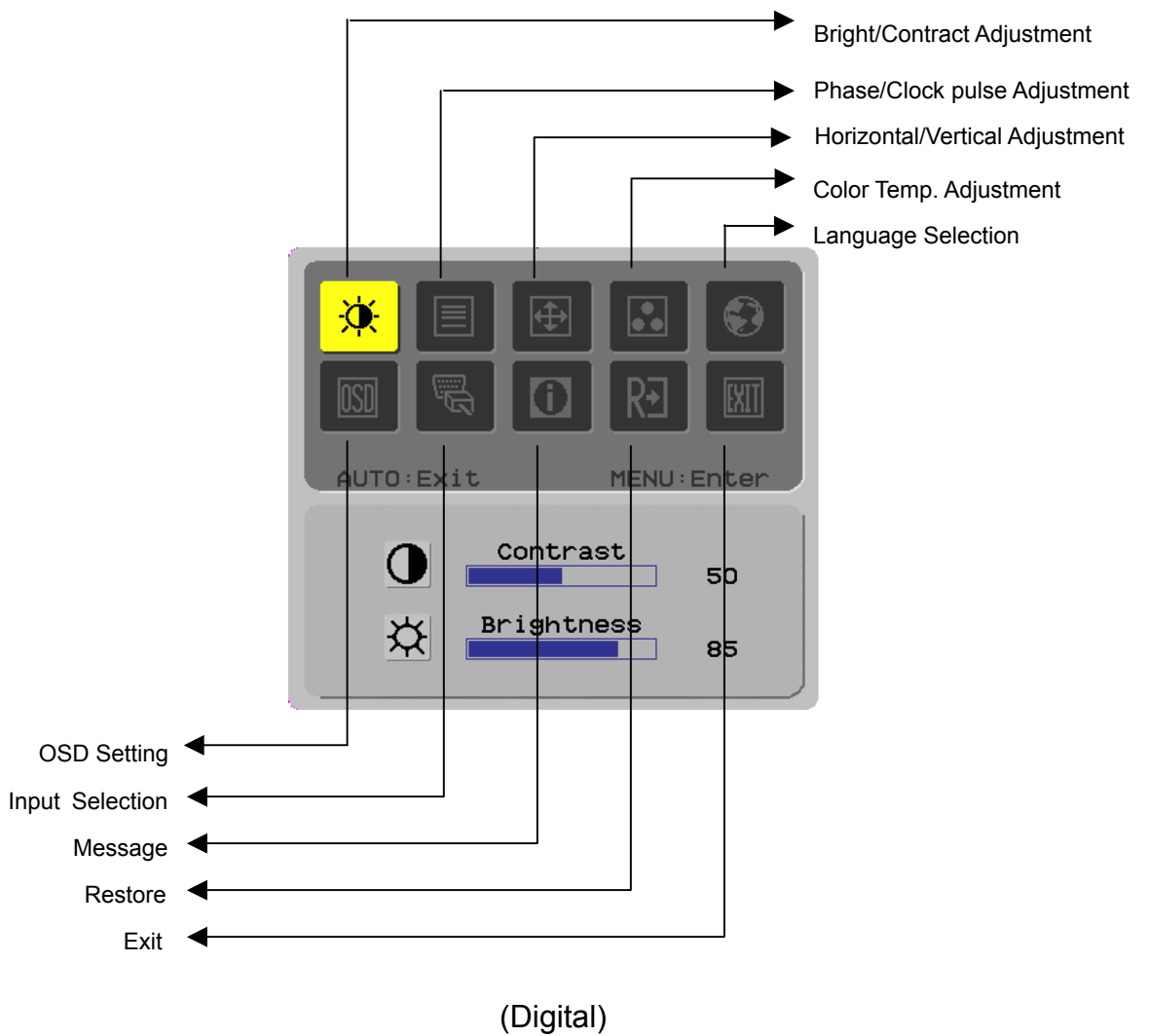

















Steps:

1. Click MENU to display the OSD window as shown in the following figure.
2. Click < or > to select the function to be adjusted as shown in the following figure.
3. Click the MENU to select the function to be adjusted.
4. Click < or > to change current settings.
5. To exit OSD, select "EXIT" to close the OSD window and save changes. To change other settings, repeat steps 2-4.



Adjustment of Screen

Function Definition

Primary Directory Symbol	Secondary Directory Symbol	Secondary Directory Items	Description
		Contrast	Adjust the contrast between the foreground and background of an image on the screen
		Brightness	Adjust the background brightness of the screen
		Phase	Adjust the focus of the image (for analog input adjustment only)
		Clock Pulse	Adjust the clock pulse of the image (for analog input adjustment only)
		Horizontal	Move the image left and right on the screen (for analog input adjustment only)
		Vertical	Move the image up and down on the screen (for analog input adjustment only)
	N/A	Warm Color Temp.	Set up the color temp. to be warm white color
	N/A	Cold Color Temp.	Set up the color temp. to be cold white color
		User Definition/Red	Adjust red/green/blue gain
		User Definition/Green	
	User Definition/Blue		
	N/A	English	Select the language you want
	N/A	繁體中文	
	N/A	Deutsch	
	N/A	Français	
	N/A	Español	
	N/A	Italiano	
	N/A	简体中文	
		Horizontal	Move OSD left and right
		Vertical	Move OSD up and down
		OSD Time Display	Adjust OSD time display settings
	N/A	Auto Adjustment	Set up horizontal, vertical, sequence and focus automatically (for analog input only)
	N/A	Analog Digital	Select the input source you want (for DVI Input only)
	N/A	Message	Display resolution, H/V frequency and the input port used for current input timing function
	N/A	Restore	Restore to factory settings
	N/A	Exit	Close the OSD window and save changes

Attachment

Plug and Play

- ◆ The product provides the latest VESA **plug and play** function to prevent complicated and time-consuming installation procedures. The **plug and play** function allows your computer system to identify the LCD display easily and set up the functions of the LCD display automatically.
- ◆ The LCD display transfers the **Extended Display Identification Data** (EDID) to your computer system via the **Display Data Channel** (DDC), so that your computer can use the self-setting function of the LCD display.

Power Saver

- ◆ The LCD display has a built-in Power Control System (**Power Saver**).
- ◆ When the LCD display is not operated during a certain time, the Power Control System will bring the LCD display into low voltage status automatically to save power. Move the mouse slightly or press any key to return to the normal operation.
- ◆ The **Power Saver** function can only be operated by the display card of the computer system. You can set up this function from your computer.
- ◆ The LCD display is compatible with EPAENERGY STAR NÜTEK when used with VESA DPMS.
- ◆ To save power and extend the life of the product, turn off the LCD display power supply when it is not used or when remaining idle for a long time.

Troubleshooting

Power LED does not light

- ◆ Check that the power switch is turned on.
- ◆ Make sure that the power cable is connected.

Icon off

- ◆ Check that the power switch is turned on.
- ◆ Make that the power cable is connected.
- ◆ Ensure that the signal cable is inserted in the receptacle appropriately.
- ◆ The Power Saver may turn off the display automatically during the operation. Make sure that the display is restored when you press any key from the keyboard.

Color Default

- ◆ Refer to “Color Temperature Adjustment” to adjust RGB color or select color temperatures.

Instability or Ripple

- ◆ Remove the electronic equipment in the vicinity that may cause EMI interference.
- ◆ Check the signal cable of the display and ensure that no pin is bent.

Image Offset or wrong Size

- ◆ Press the auto adjustment button to optimize the screen automatically.
- ◆ Set up the reference position.

Technical Specifications

LCD Panel (Back Light Source)	Panel Dimension	Diagonal 481.9mm (19 inch) LCD display
	Max. Resolution	1,280 x 1,024/ SXGA
	Max. Pixel	Up to 16.2M true color
	Pixel Span	Horizontal 0.294mm x Vertical 0.294mm
	Brightness	300 cd/m ²
	Contrast	800 : 1
	LC Response Time	23ms
	Visual Angle	Horizontal 170° / Vertical 170°
	Effective Display	Horizontal 376.32mm x Vertical 301.056mm
Input Signal	Signal Mode	Simulated video frequency: 0.7 Vpp, 75Ω (separate SYNC and composite SYNC)
	SYNC Frequency	Horizontal 30kHz~82kHz x Vertical 56Hz ~76 Hz
	Max. Pixel Clock	135MHz
Input Terminal	Image	D-Sub 15 PIN (VESA) / DVI-D (Optional)
	Audio	Phone Jack, d=3.5mm (Optional)
Power Transformer		AC100~240Volts, 50/60Hz
Power Consumption		65W / Standby 3W
Environmental Conditions	Temperature	5°C ~ 35°C (operation)/ -20°C ~ 55°C (storage)
	Humidity	20% ~ 80% (operation)/ 20% ~ 85% (storage)
Actual Dimension (W x D x H)		427 mm x 196mm x 429mm
Net Weight		4.5 kg
Safety Standard		TCO99;UL/CUL;TÜV-GS;CE/LVD;TÜV-ERGO;CB;CCC;FCC-B; VCCI-B;CE/EMC;C-Tick; BSMI; ISO 13406-2;EPA; PCT

Display Mode

- ◆ If the signal of your PC system is the same as one of the following reference signal modes, the screen will be adjusted automatically. If not, the screen will not display or only the LED lights will display. For more information about the adjustment mode, refer to the instructions of your display card.

	Display Mode	Hor. Frequency (kHz)	Vert. Frequency (Hz)	Pixel Frequency (MHz)	SYNC Polarity (H/V)
VESA	VGA 640x480	31.469	59.940	25.175	-/-
		37.861	72.809	31.500	-/-
		37.500	75.000	31.500	-/-
	SVGA 800x600	35.156	56.250	36.000	+/+
		37.879	60.317	40.000	+/+
		48.077	72.188	50.000	+/+
		46.875	75.000	49.500	+/+
	XGA 1024x768	48.363	60.004	65.000	-/-
		56.476	70.069	75.000	-/-
		60.023	75.029	78.750	+/+
	SXGA 1152x864	67.500	75.000	108.000	+/+
	SXGA 1280x1024	63.981	60.020	108.000	+/+
79.976		75.025	135.000	+/+	
VGA TEXT	720 x 400	31.469	70.087	28.322	-/+
Macintosh	640x480	35.000	66.667	30.240	-/-
	832 x 624	49.725	74.500	57.283	-/-
	1024 x 768	60.150	74.720	80.000	-/-