

Acer FP563

LCD Color Monitor

15.0" (38.1cm) LCD Panel Size

User's Manual

acer

Copyright

Copyright © 2001 by Acer Communications & Multimedia Inc. All rights reserved. No part of this publication may be reproduced, transmitted, transcribed, stored in a retrieval system or translated into any language or computer language, in any form or by any means, electronic, mechanical, magnetic, optical, chemical, manual or otherwise, without the prior written permission of Acer Communications & Multimedia Inc.

Disclaimer

Acer Communications & Multimedia Inc. makes no representations or warranties, either expressed or implied, with respect to the contents hereof and specifically disclaims any warranties, merchantability or fitness for any particular purpose. Further, Acer Communications & Multimedia Inc. reserves the right to revise this publication and to make changes from time to time in the contents hereof without obligation of Acer Communications & Multimedia Inc. to notify any person of such revision or changes.

**Safety
Instructions**

1. The AC adapter isolates this equipment from the AC supply.
2. Unplug this product from the wall outlet before cleaning. Do not use liquid or aerosol cleaners. Use a soft cloth to clean the monitor housing and a tape to stick dust and fingerprints on the screen panel.
3. Slots and openings on the back or top of the cabinet are provided for ventilation. They must not be blocked or covered. This product should never be placed near or over a radiator or heat register, or in a built-in installation unless proper ventilation is provided.
4. This product should be operated from the type of power indicated on the marking label. If you are not sure of the type of power available, consult your dealer or local power company.
5. Never push objects of any kind, or spill liquid of any kind into this product.
6. Do not attempt to service this product yourself, as opening or removing covers may expose you to dangerous voltages or other risks. If any above mentioned misuse or other accident (dropping, mis-operations) occurs, contact qualified service personnel for servicing.
7. The power supply cord serves as a power disconnect device for pluggable equipment. The socket outlet shall be installed near the equipment and shall be easily accessible.

**Table
of
Content**

Unpacking	3
Views of the Monitor	4
Front View	4
Back View (1)	4
Back View (2): Removal of rear cover and base cover	5
Installation	6
Hardware Installation	6
Monitor Security Lock Installation	8
USB Installation (Optional)	8
Software Installation	9
Adjusting the Monitor	35
A Look at the Control Panel	35
Hot Key Mode	35
Main Menu Mode	36
Troubleshooting	41
Frequently Asked Questions (FAQ)	41
Need More Help?	42
Supported operating modes	43
Specifications	44
Appendix: An Introduction to LCD Technology	45
Principles of LCD Technology	45
The TFT panel	45
Important LCD parameters	46
Display errors	46
Comparison of CRT & LCD monitors	48
Summary	48

Unpacking

Please check you have the following items. If they are missing or are damaged, please contact the dealer immediately at which you purchased the good.

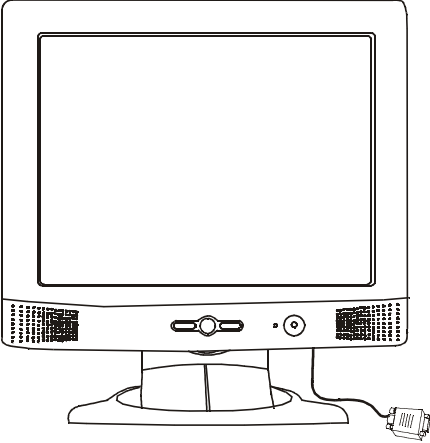
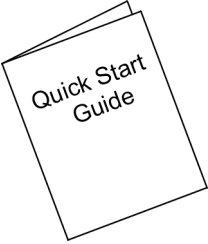
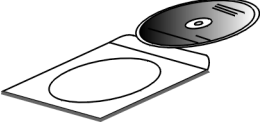
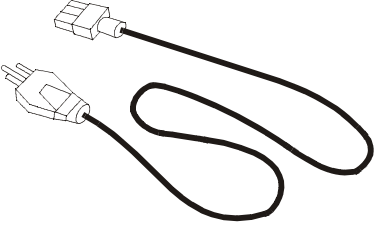
LCD monitor with signal cable	
Quick Start Guide	
CD-ROM	
Power cord	

Views of the Monitor

Front View

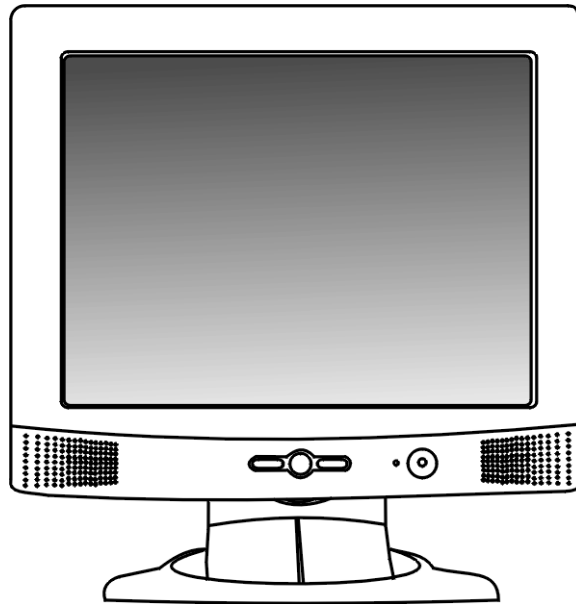

Back View (1)

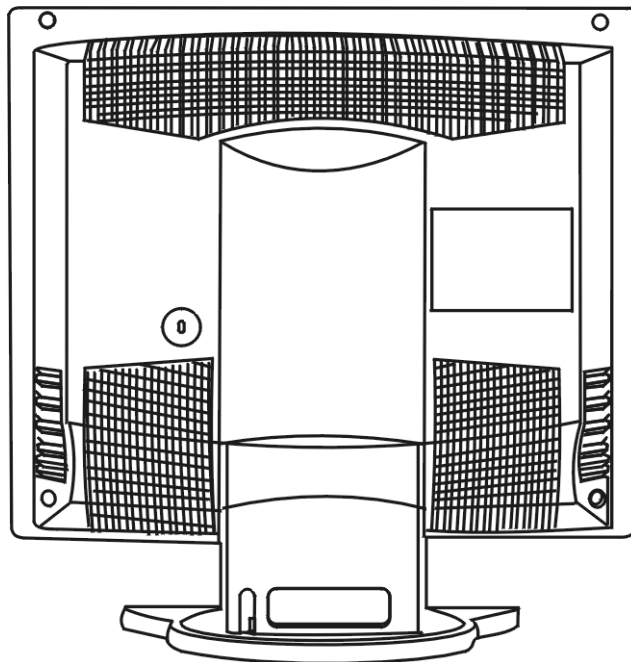

Back View (2): Removal of rear cover and base cover

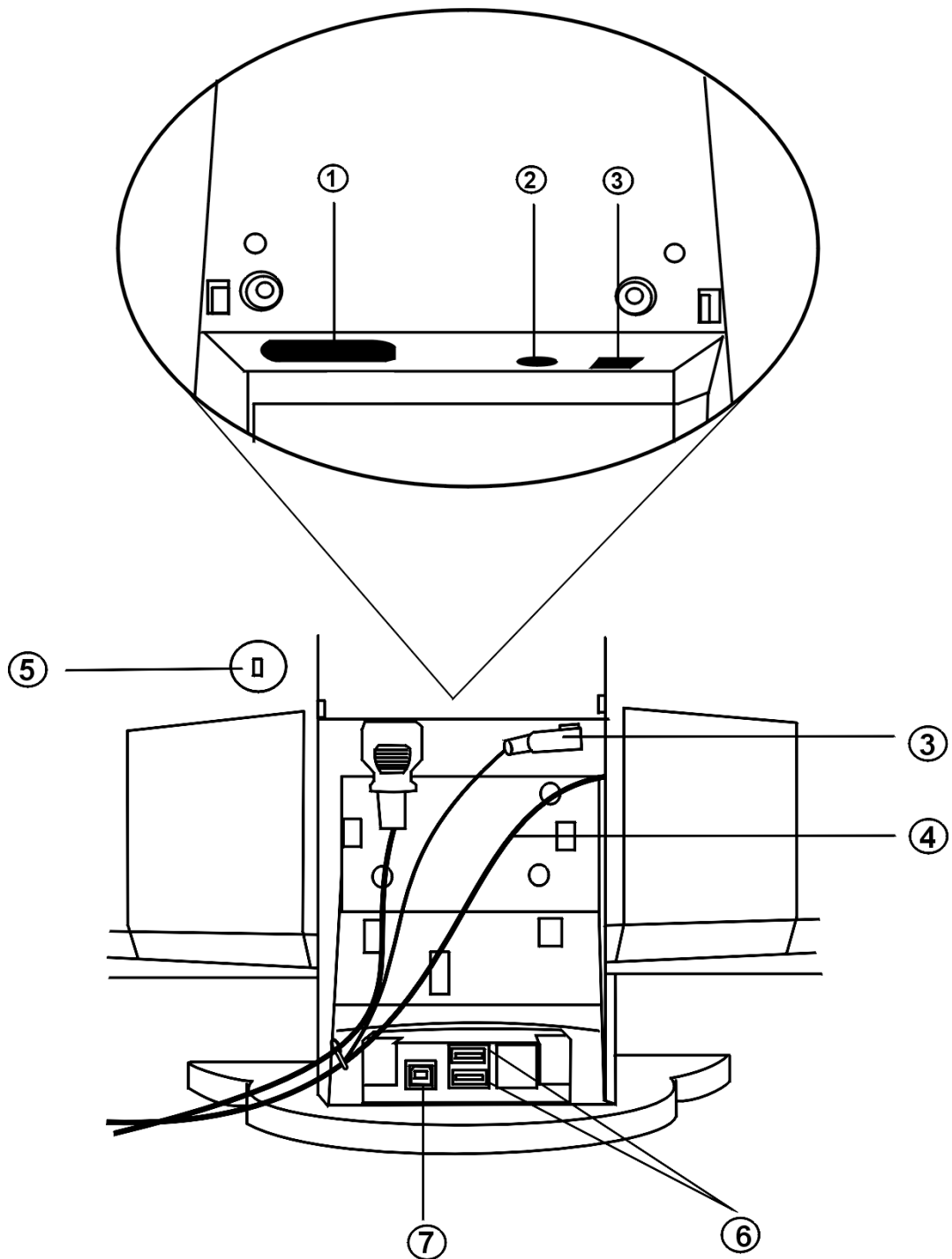

1. Power outlet	2. Audio jack
3. USB power outlet (optional)	4. Video cable
5. Kensington lock	6. USB port (downstream) * Connect to peripherals
7. USB port (upstream) * Connect to computer	

Installation

Hardware Installation

A. Make sure that the computer and monitor's power are both turned off. Please follow the steps to install your LCD monitor.

1. Lay the monitor on the desk. Take off the rear cover.

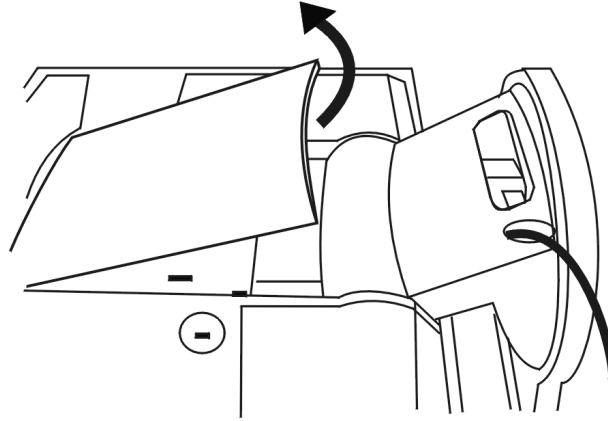

2. Then take off the base cover.

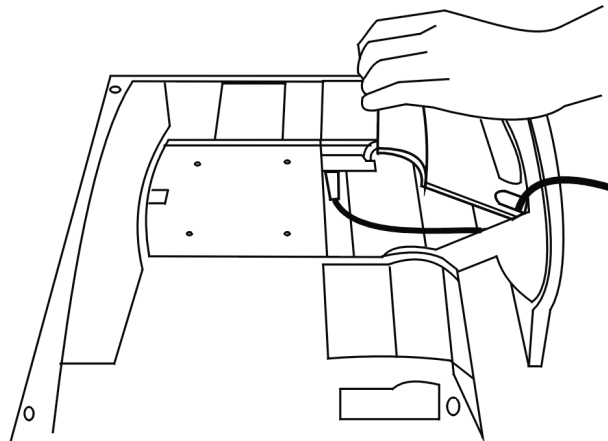

3. Connect the power cord to your LCD monitor. then connect audio cable to the Audio Input of Acer LCD monitor.

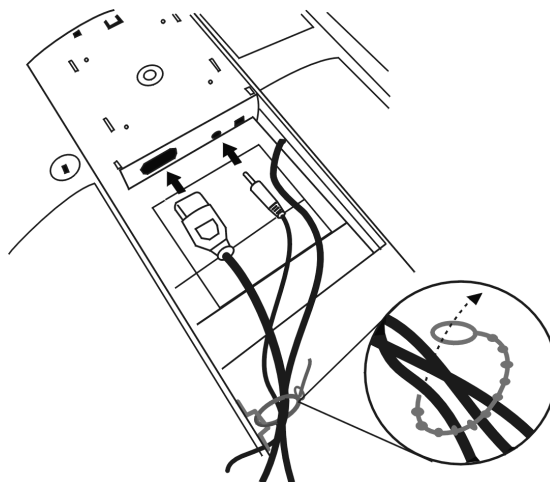

4. Put base cover back.

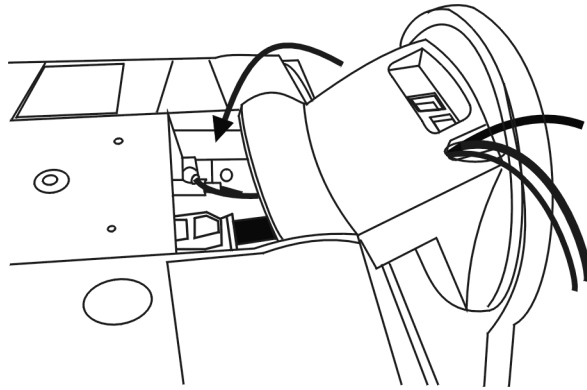

5. Put the rear cover back.

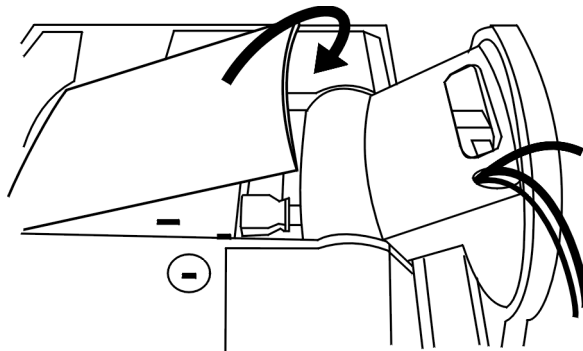

B. Plug the audio cable into the signal connector of your monitor.

C. Connect the video cable, which is directly attached to the monitor, to the VGA output of the graphics card on the computer.

D. Connect the power cord at the back of the monitor to an AC power socket. Please make sure that the socket is not blocked or covered, so you can disconnect the unit from AC supply if you need to. Your monitor is equipped with an automatic power supply for a voltage range from 100 to 240 Volt at a frequency of 50 to 60 Hz. Be sure that your local power is within the supported range. If you are unsure, ask your electricity supplier.

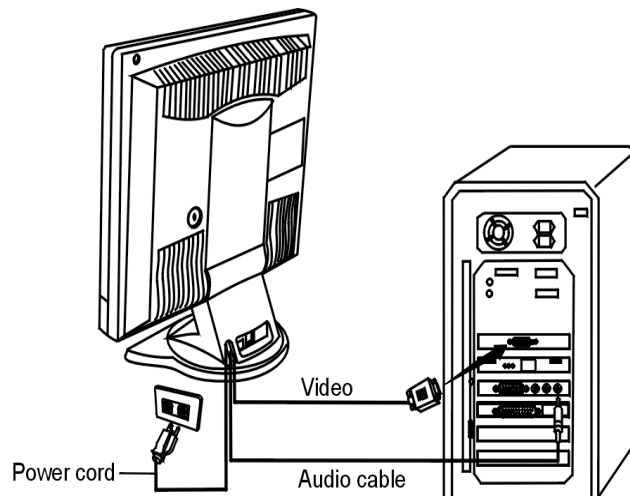

Monitor Security Lock Installation

The monitor can be secured to your desk or any other fixed object with Kensington lock security product. The cable can be attached to a slot located on the rear of your monitor.

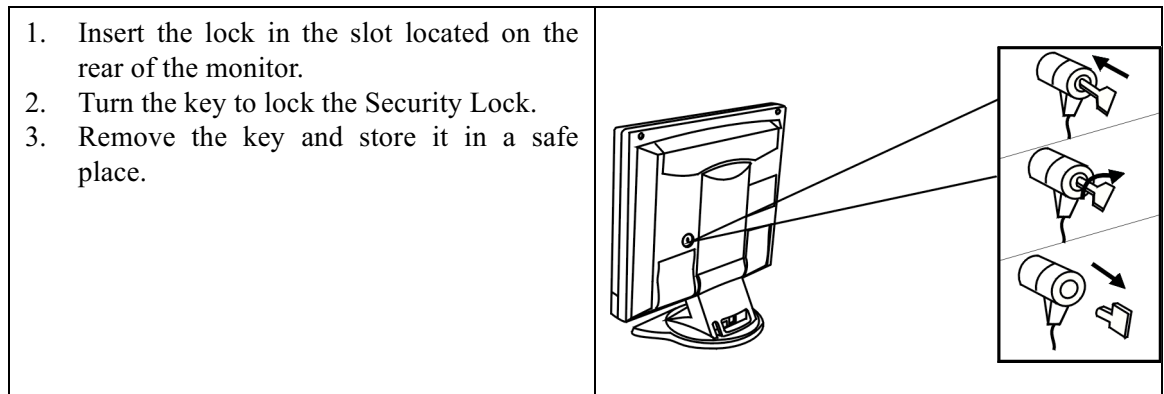

The Kensington lock is not Acer Accessory. It cannot be ordered from Acer. Contact your reseller for more information.

USB Installation (Optional)

A USB-Hub is integrated in the base of your monitor pedestal. USB connectors automate peripheral connection by using plug&paly installation procedures.

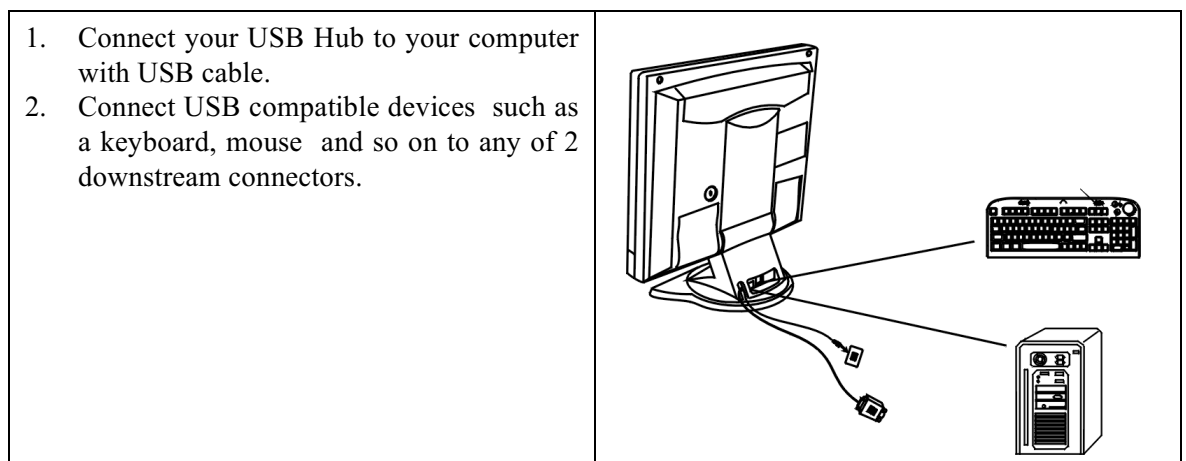

Software Installation

A. Microsoft® Windows® 95 / 98 / 2000

If you are using Windows 95, Windows,98 or Windows 2000 as an operating system, you have to set up the correct monitor driver.

Windows 95. The first time you start Windows with a new monitor, the system will detect it and automatically installs the driver for plug and play displays. To install the current driver from CD, proceed as follows:

1. Insert “Acer LCD Monitor” CD-ROM into your CD-ROM Driver.
2. Click “Start” then “Settings”.

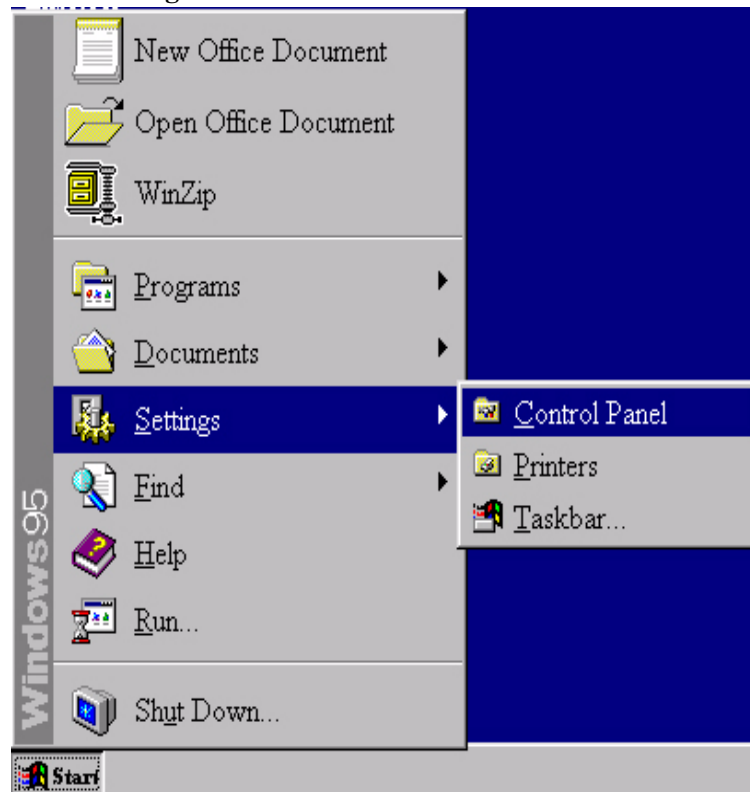

3. Double click the “display” icon in the control panel.

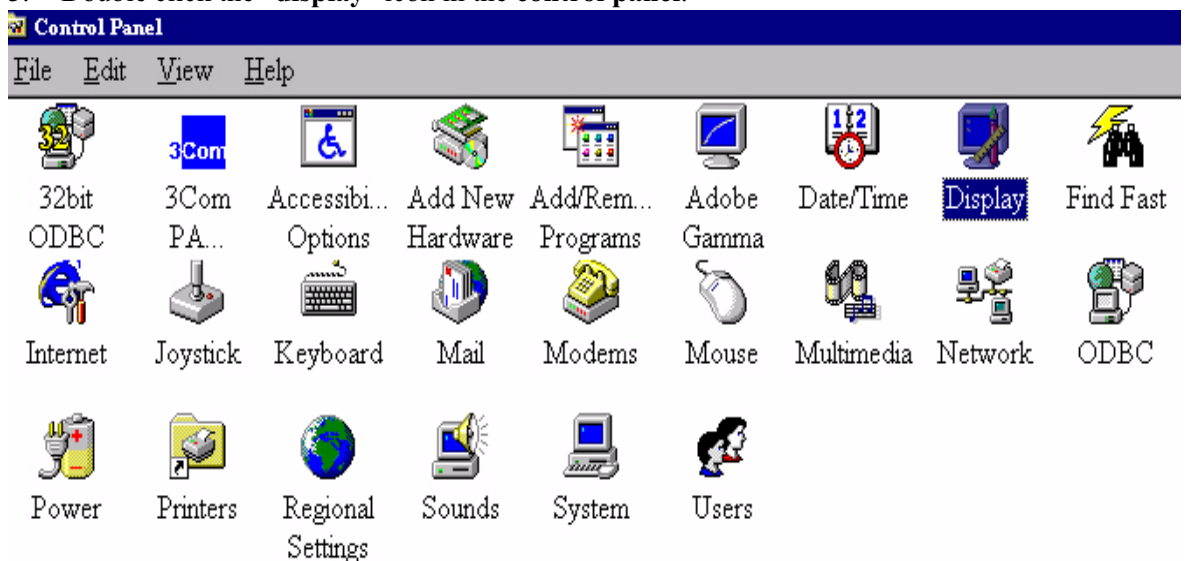

- From the “**Display properties**” window, select the “**Settings**” tab. Click the “**Advanced Properties**” button in the bottom right corner.

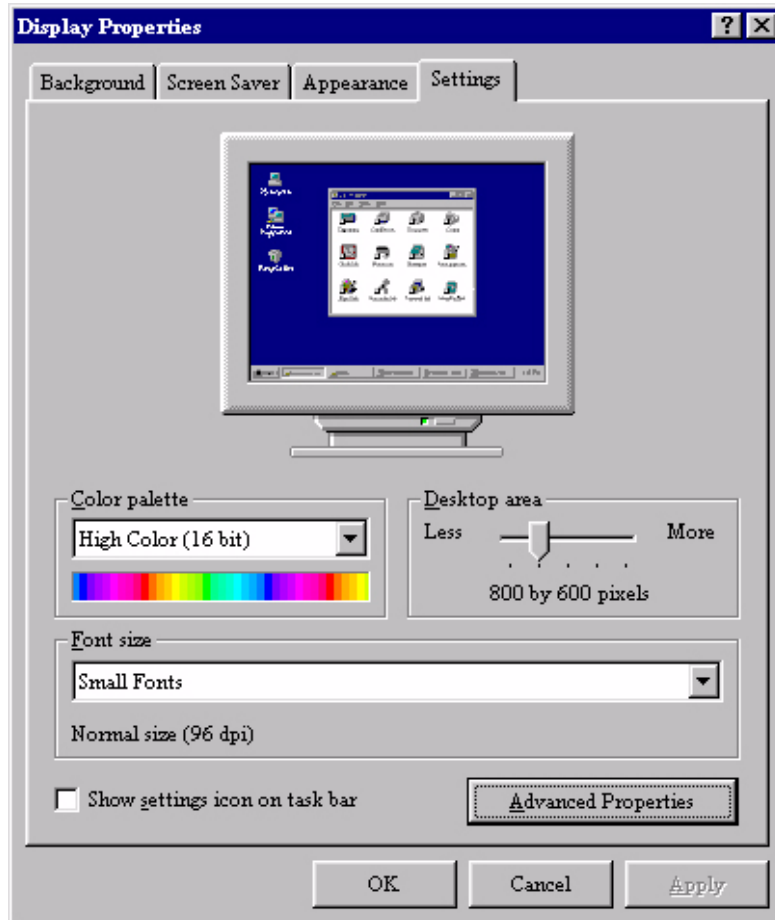

- Select the “**Monitor**” tab. Click the “**Change**” button in the top right corner.

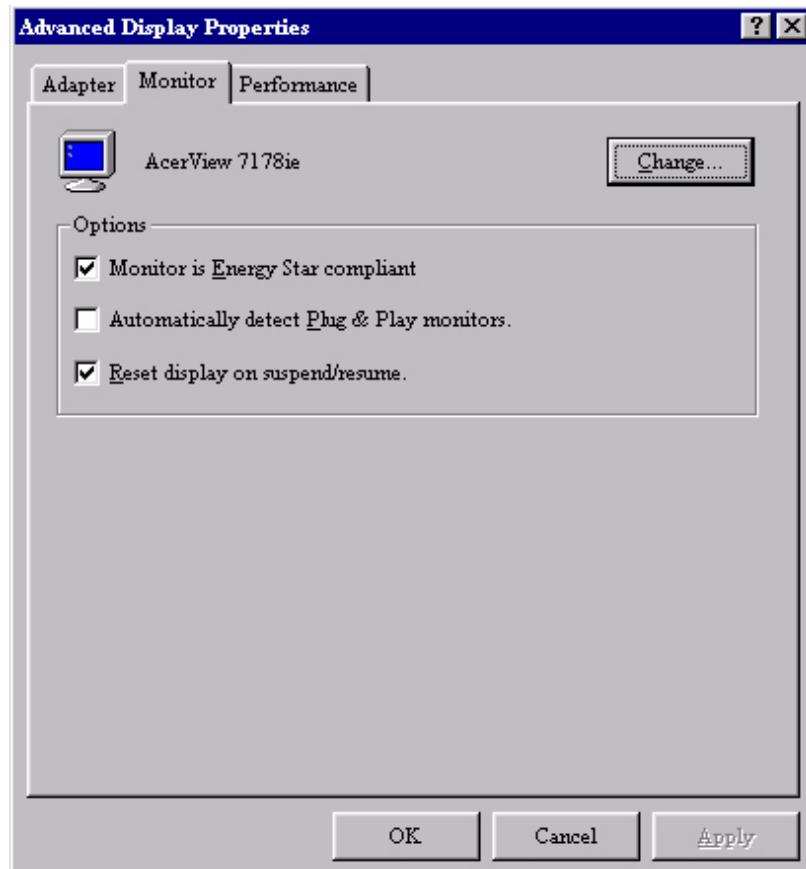

6. Now click the “**Have disk**” button in the bottom right corner. Another window appears, select the “**Browse**” button.

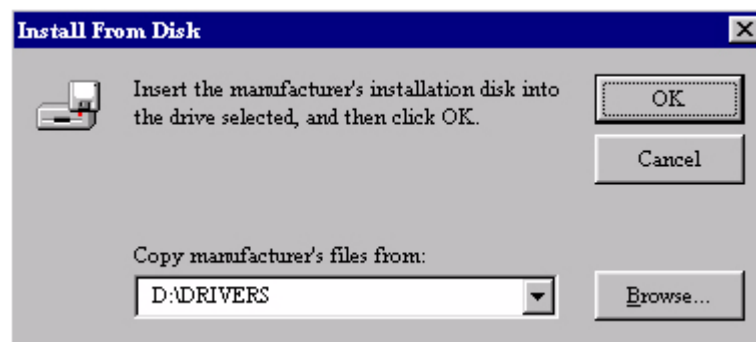
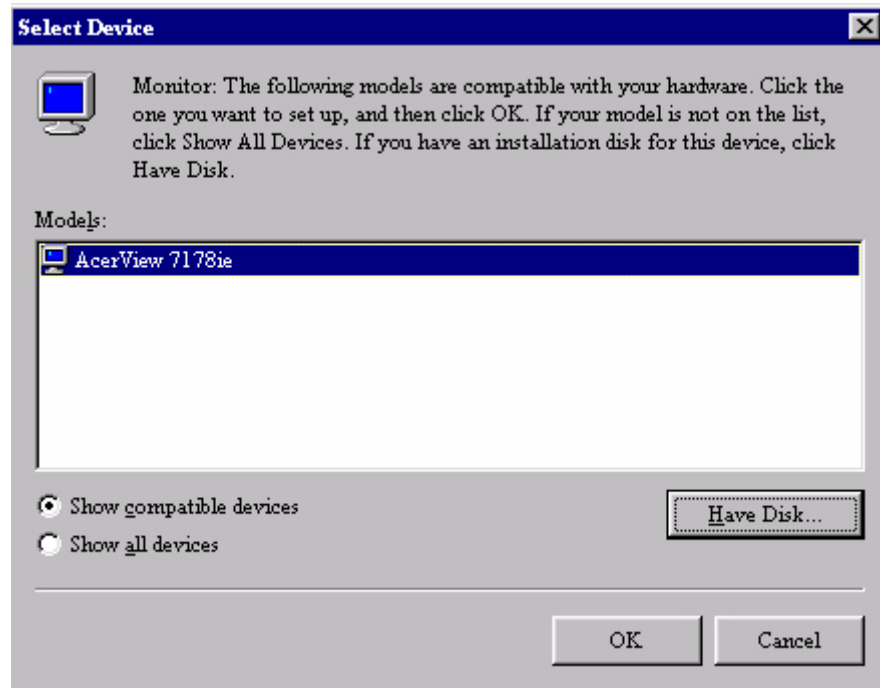

7. The drive selection is located at the bottom of the window in the center. Insert the CD supplied with your monitor into your computer and select the CD-drive.
8. In the field above the drive selection, change to the “**Drivers**” folder. The current driver files are located there. Press “**OK**” and the window closes.

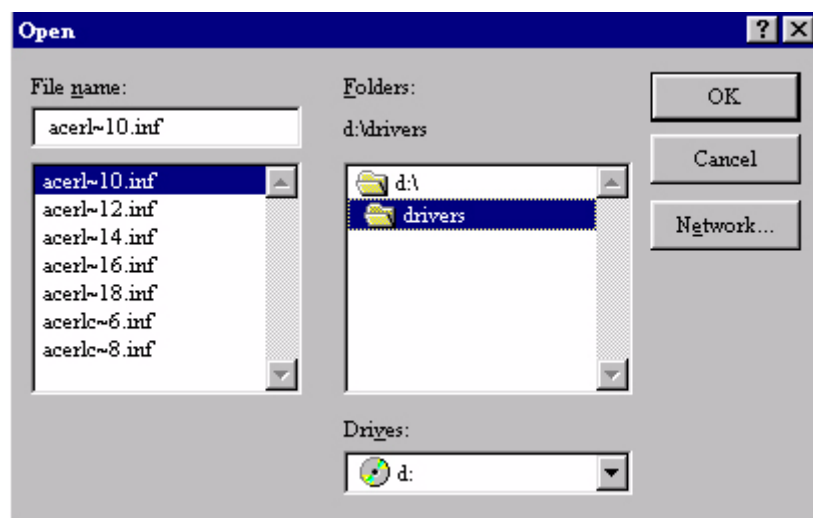

9. By pressing “OK” again in the next window you will be given a list of compatible devices. Select “FP563” from the list and press “OK” again.

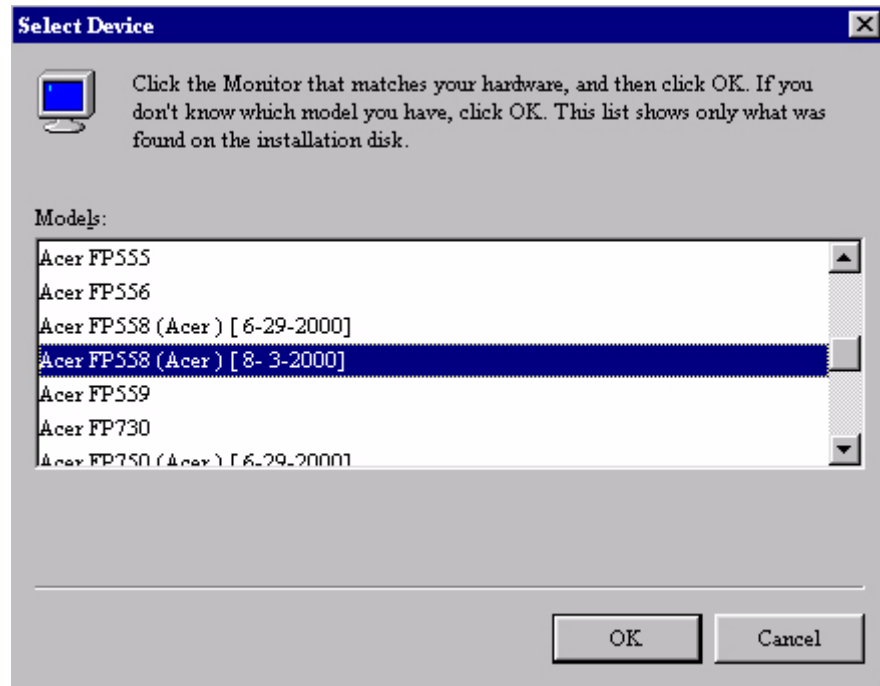

10. Now you are back to “Advanced Display Properties”. Close this window by clicking “OK” and confirm the following messages with “Yes”. Click “OK” and “Yes” again. The installation is now completed. You can close “Display Properties”.

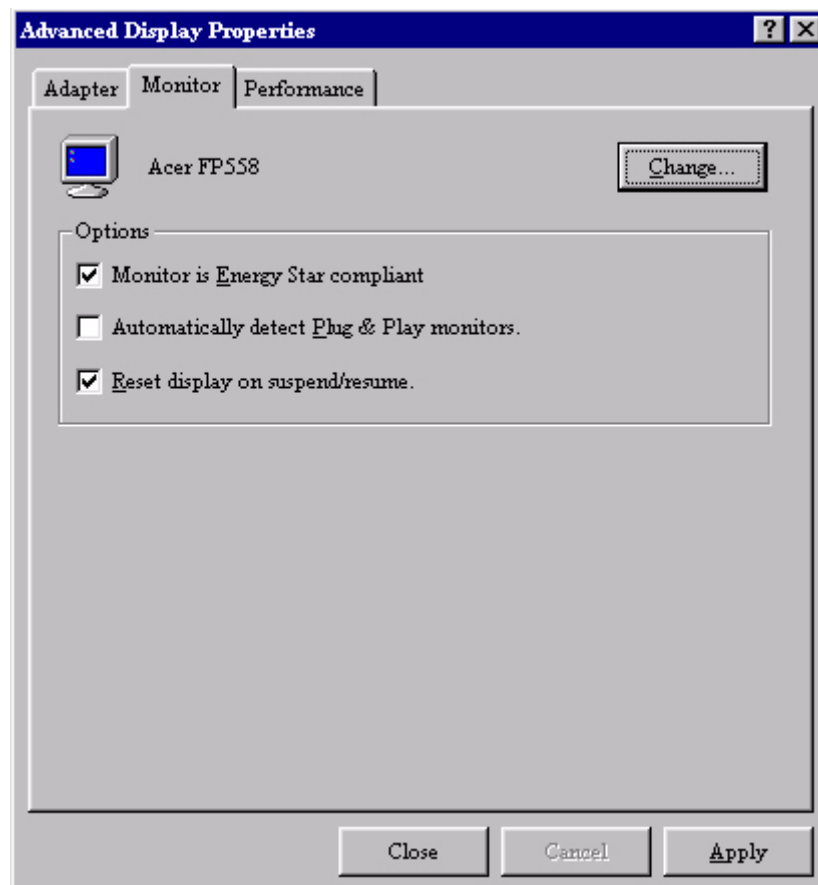

Windows98. To manually install or update the driver, perform the following steps:

1. Open the control panel and double-click "**Display**" icon.

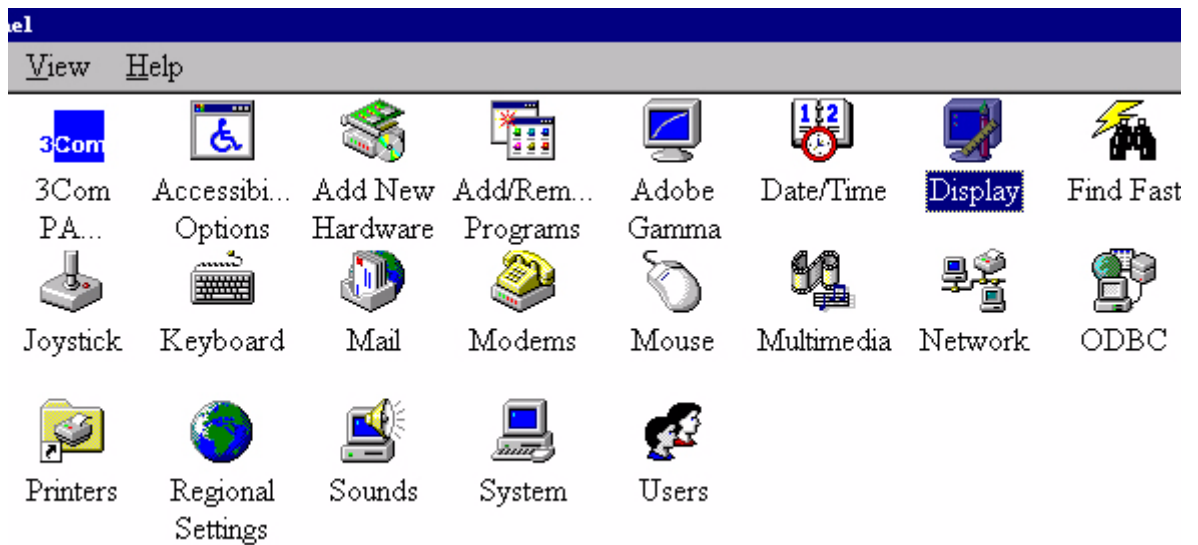

2. From the "**Display Properties**" window, select the "**Settings**" tab. Click the "**Advanced Properties**" button in the bottom right corner.

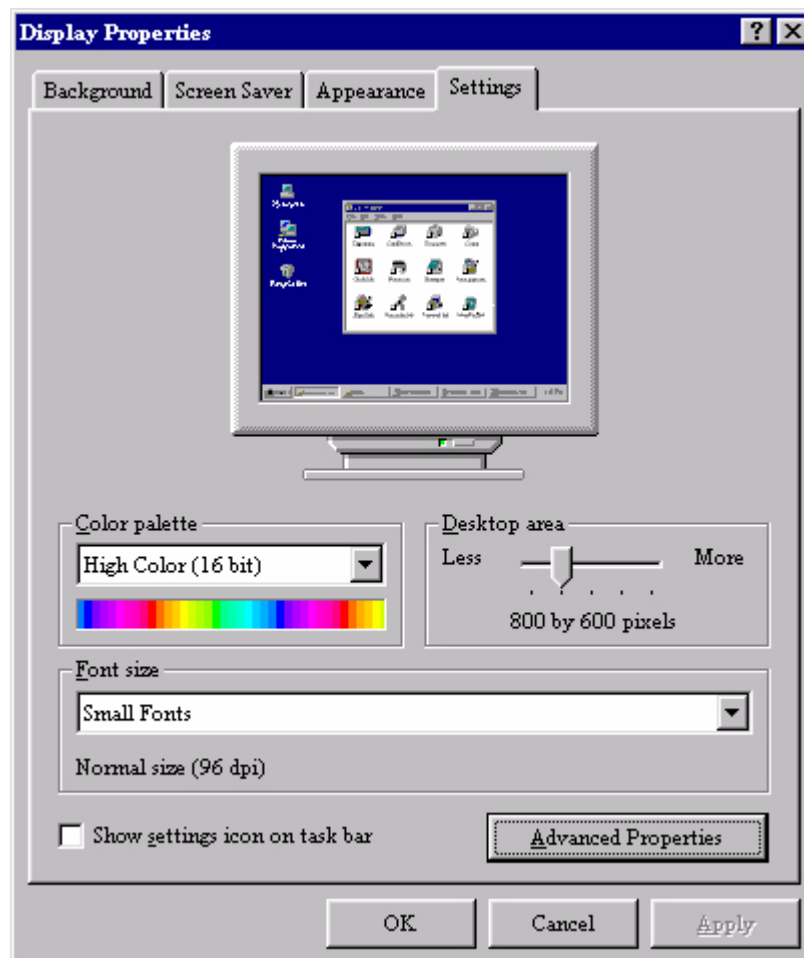

3. Select the "**Monitor**" tab. Click the "**Change**" button in the top right corner.



4. Now the "**Update Device Driver Wizard**" opens. Confirm by clicking "**Next**".



5. Select "**Display a list of all drivers in a specific location, so you can select the driver you want.**" and press "Next".



6. Now click the "**Have disk**" button in the bottom right corner. Another window appears, select the "**Browse**" button.

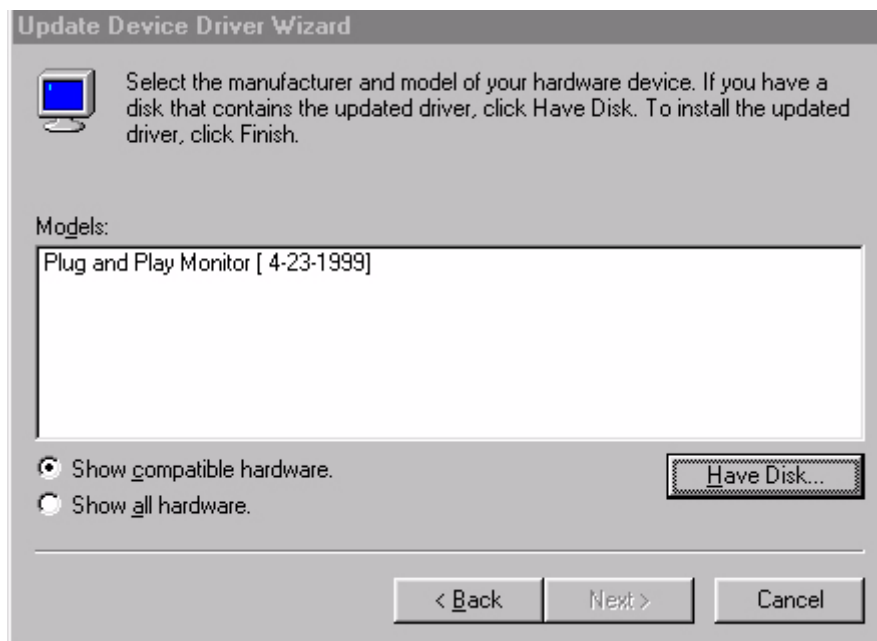

- The drive selection is located at the bottom of the window in the center. Insert the CD supplied with your monitor into your computer and select the CD-drive.



- By pressing “OK” again in the next window you will be given a list of compatible devices. Select “FP563” from the list and press “Next” again.

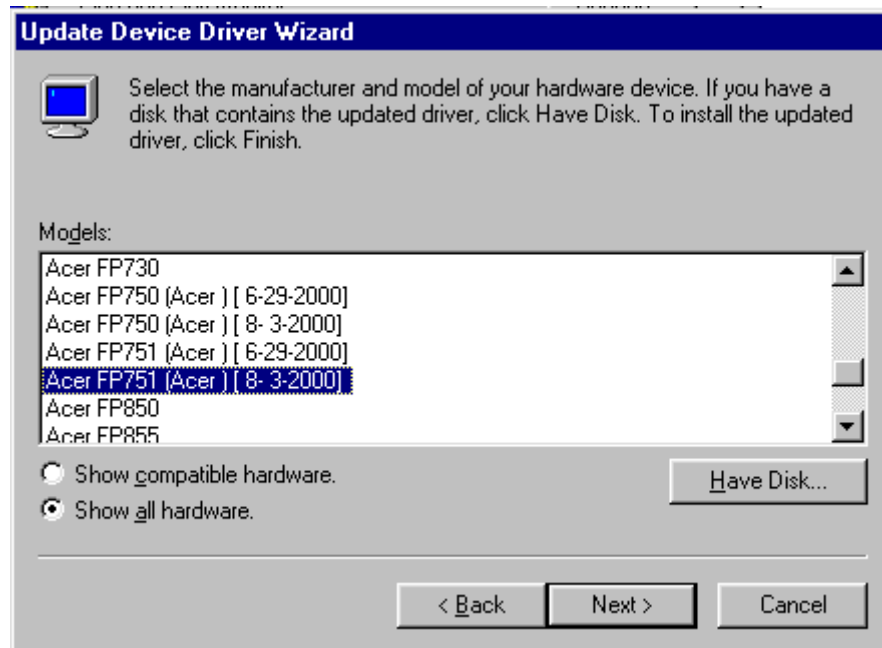

- A “Insert Disk” dialogue box appears. Click “OK”, and then click “Skip File”.

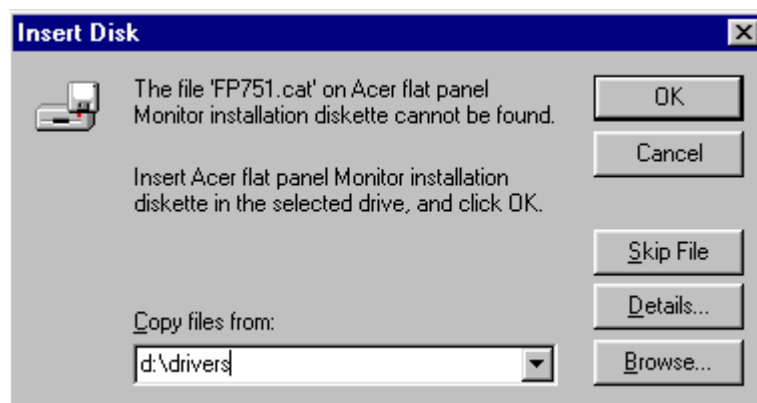
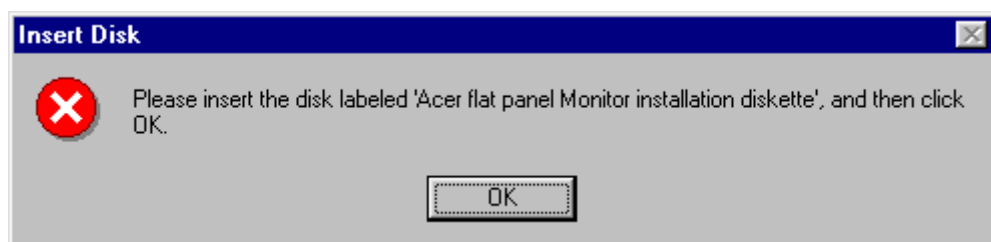

10. Close “Update Device Driver Wizard” by click “Finish” to complete the installation.



Windows 2000 . The first time you start Windows with a new monitor, the system will detect it and automatically starts with the “**Add New Hardware Wizard**”. Carry out the instructions beginning at step 4.

1. Insert “**Acer LCD Monitor**” CD-ROM into your CD-ROM Driver.
2. Click “**Start**” then “**Settings**”.

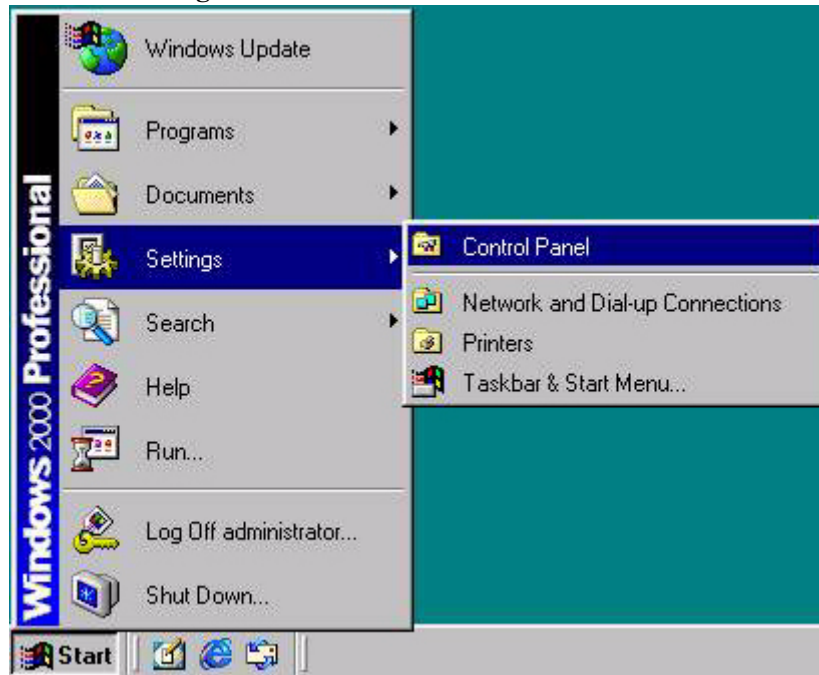

3. Open the control panel and double click on the “**Display**” icon.

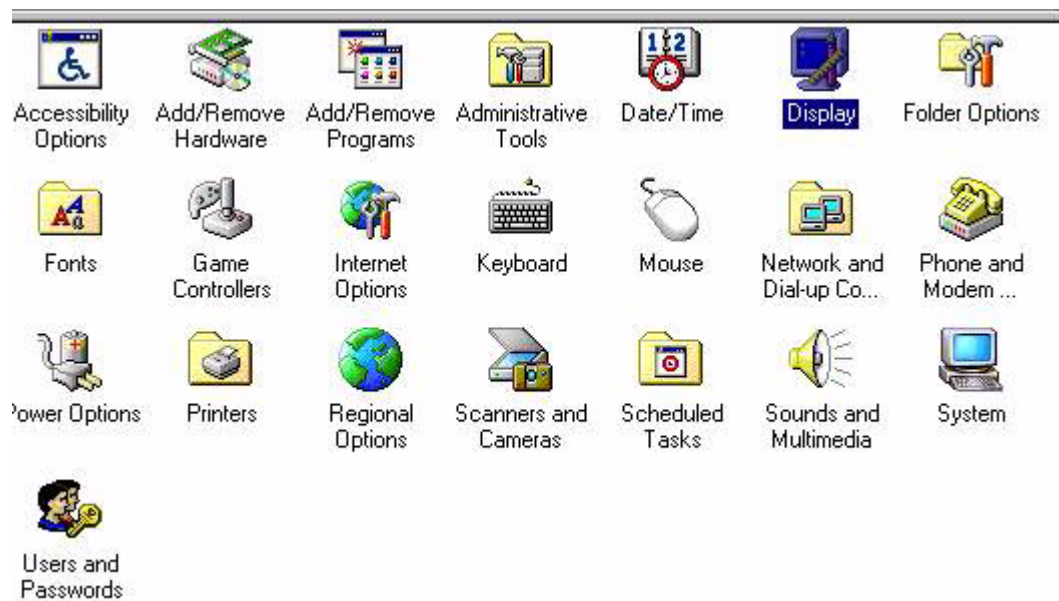

- From the “**Display Properties**” window, select the “**Settings**” tab. Click the “**Advanced Properties**” button in the bottom right corner.

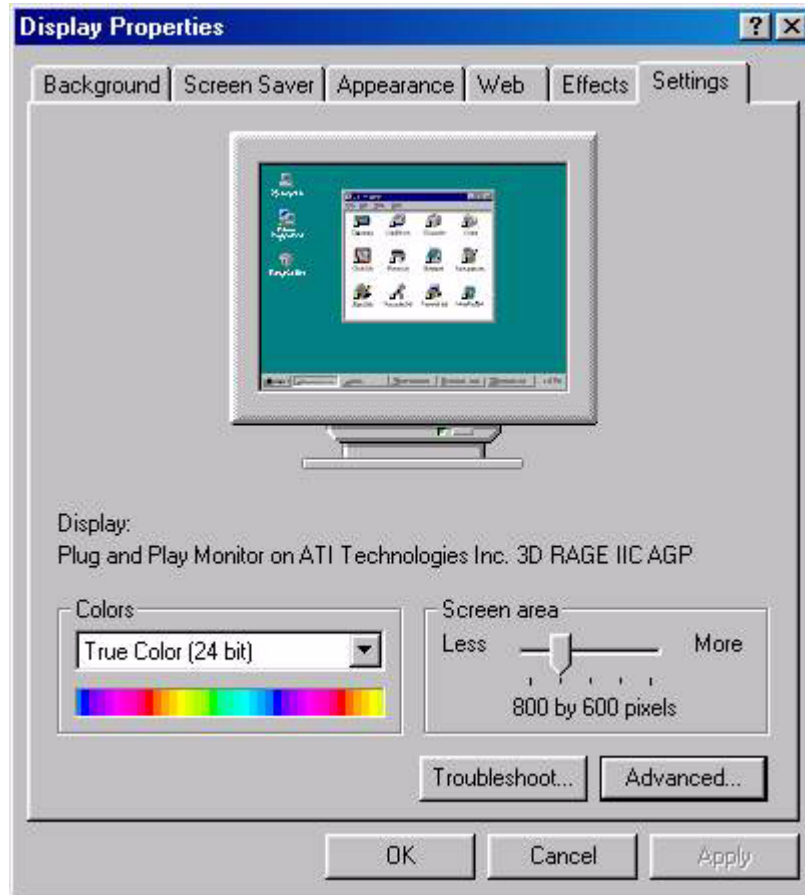

- Select “**Monitor**” then click “**Properties**”.

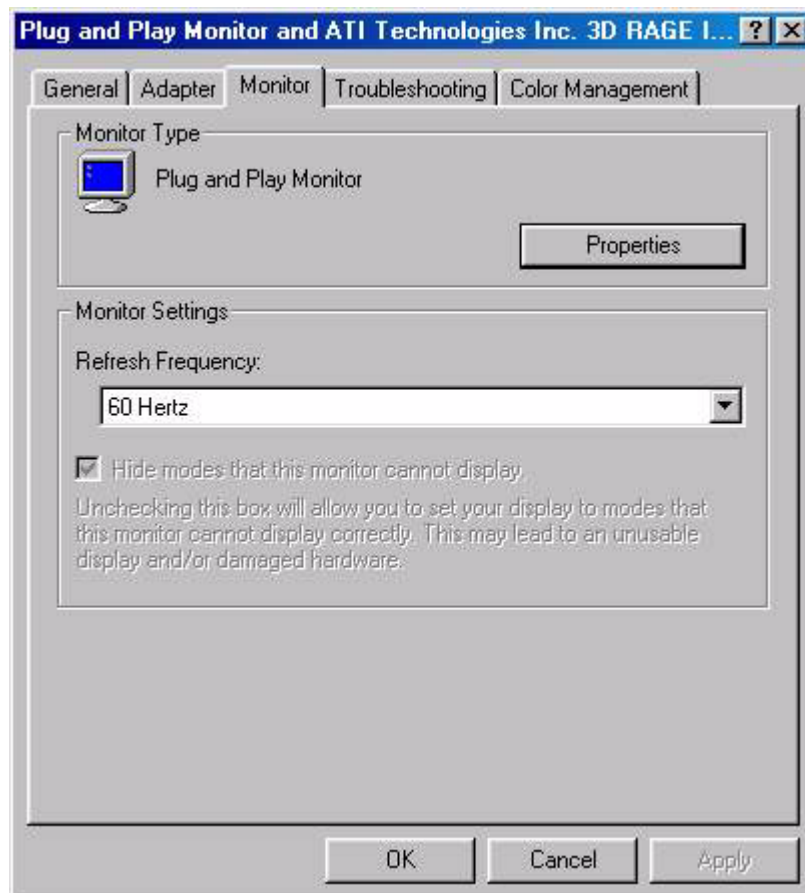

6. Select **“Driver”** tab then click **“Update Driver”**.



7. The **“Upgrade Device Driver Wizard”** will pop up. Then Click **“Next”**.



8. Select “**Display a list of the known drivers for this device so that I can choose a specific driver**” then click “**Next**”.



9. In the next window, click “**Have Disk**”, then “**Install From Disk**” window will pop up, click “**Browse**”, the “**Located File**” will pop up.

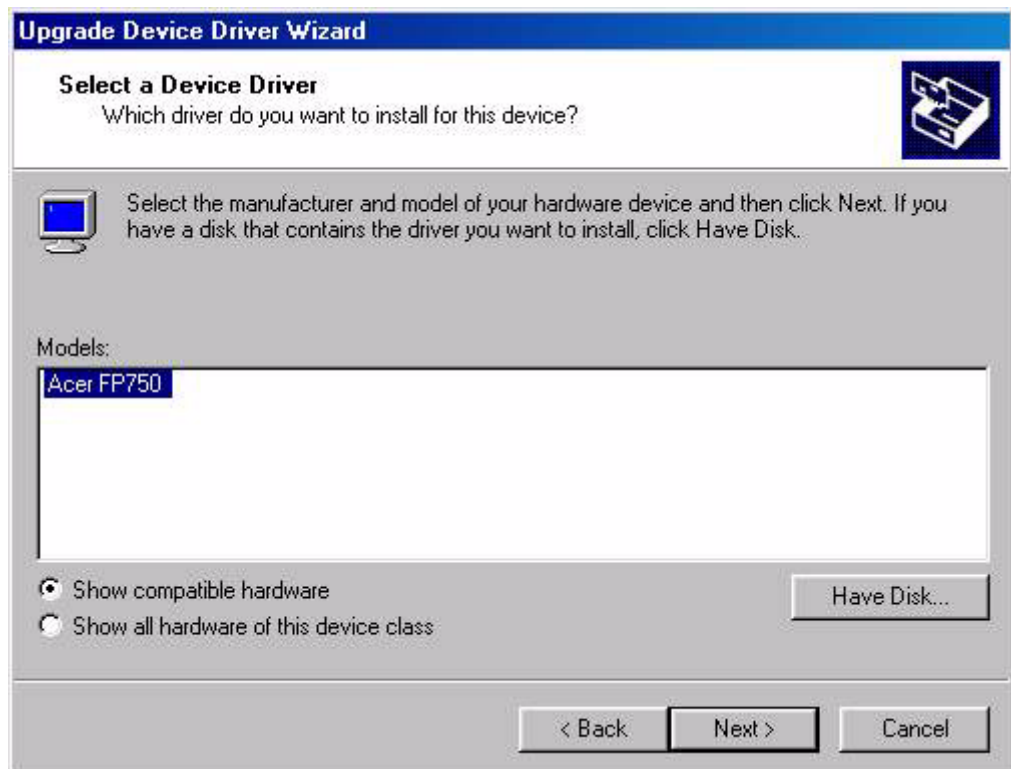



10. In this window, click on the arrow (▼) of 'Look in' box, then select your CD ROM Drive.

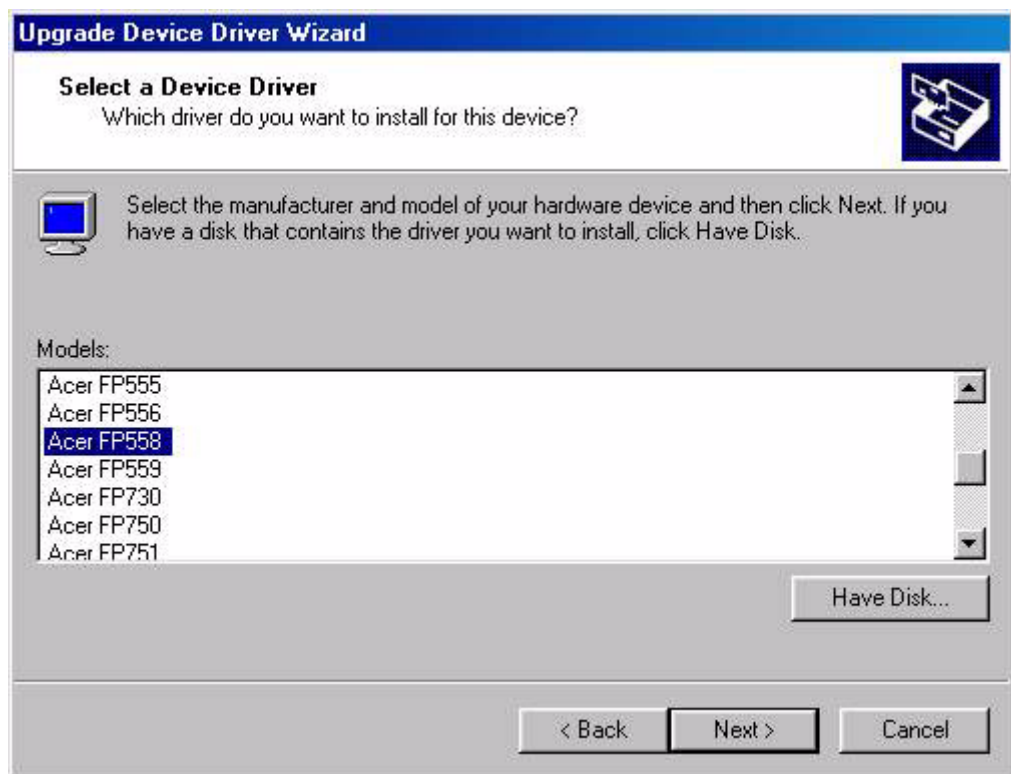

11. In the list of CD-ROM, select “**Drivers**” folder then click “**Open**” twice, then click “**OK**”, Select the your LCD Mode (FP563) from the list in the next window then click “**Next**” twice.



12. The “**Digital Signature Not Found**” window will appear, click “**Yes**”, then click “**Finish**”.

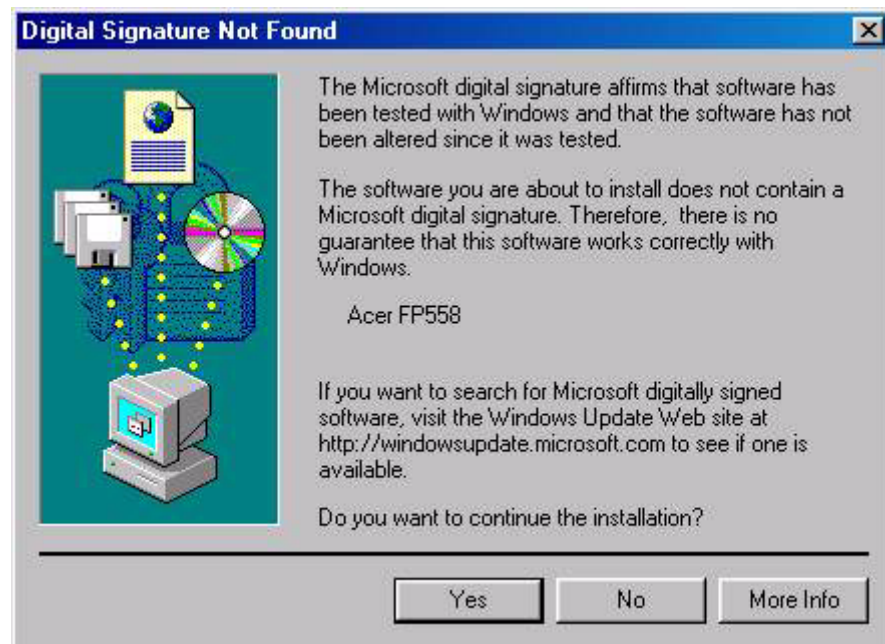

13. Now the new drivers are installed to your computer.



Windows ME . To manually install or update the driver, perform the following steps:

1. Click “**Start**”, “**Settings**”, “**Control Panel**” and then double-click “**Display**”.
2. In the Display Properties window, click the “**Settings**” tab and click “**Advanced...**”.
3. Click the “**Monitor**” tab and then click “**Change**”.

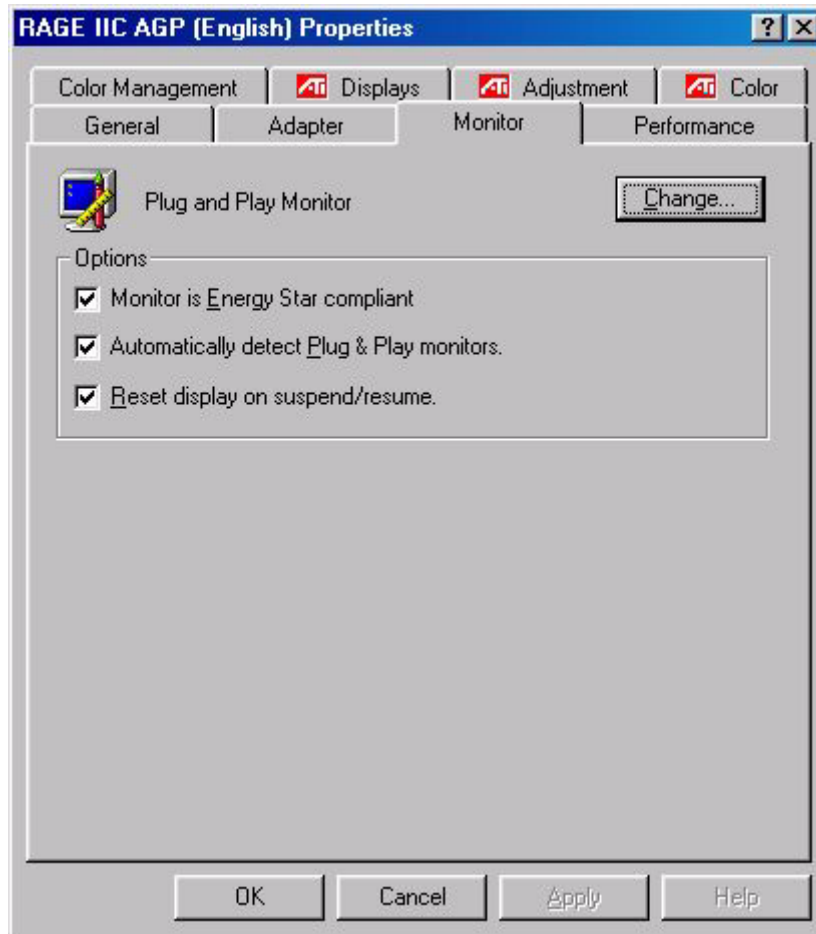

4. “**Update Device Driver Wizard**” dialogue box appears. Choose “**Specify the location of the driver (advanced)**” and then click “**Next**”.



- Choose “**Display a list of all the drivers in a specific location, so you can select the driver you want**” and click “**Next**”.



- Choose “**Monitor**” from the list and then click “**Next**”.

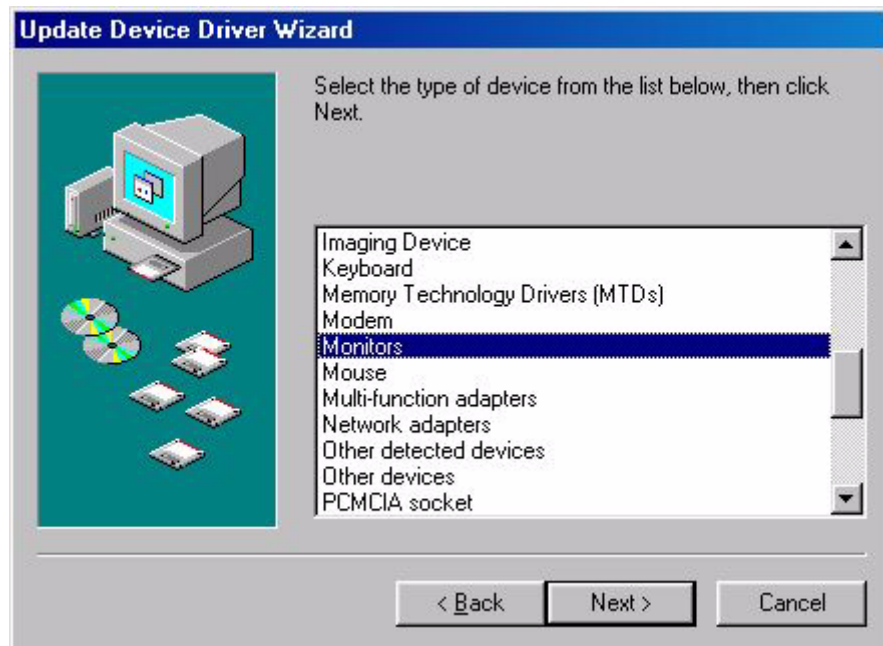

7. Choose “**Display a list of all the drivers in a specific location, so you can select the driver yourself**”.

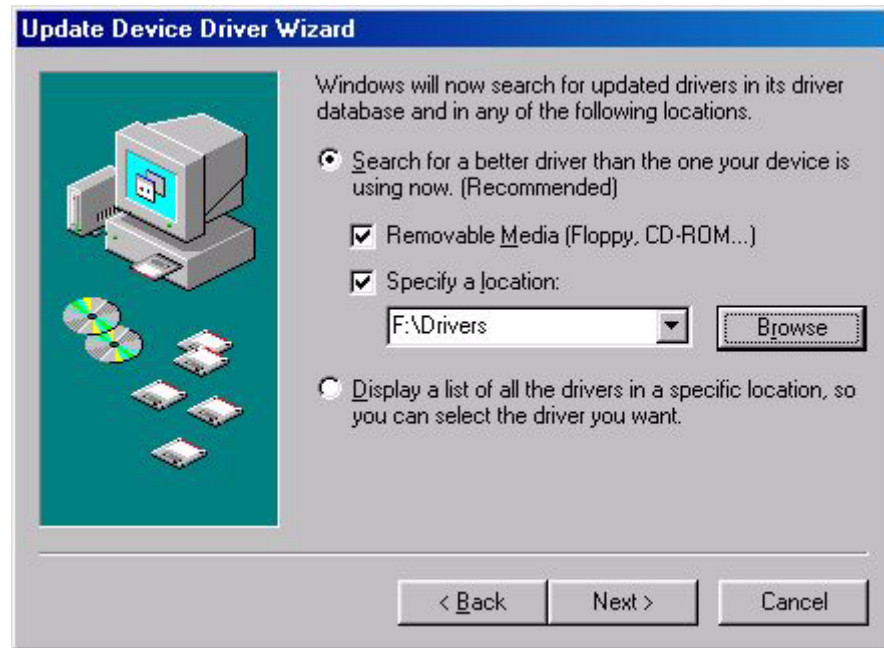

8. Click “**Have disk**” and then click “**Browse...**”.

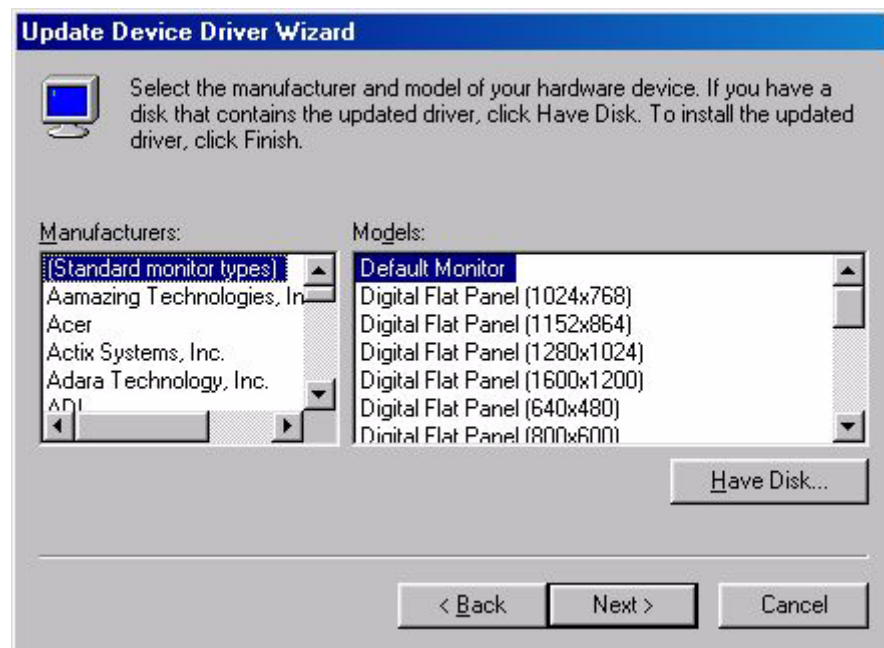

9. Insert “**Acer LCD monitor**” into your CD-ROM and type d:\ (change the driver letter to match your CD-ROM driver if it is not drive D). Enter “**Drivers**” folder to select the model from the list left. Click “**OK**”.



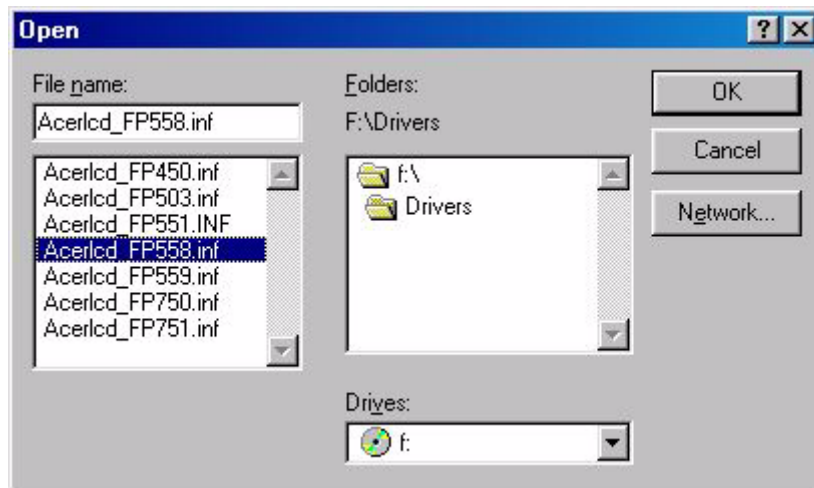

10. Back to “Install From disk” and click “OK”. The dialogue box “Update Device Driver Wizard” appears. Choose the model from the list, then click “Next”.



11. Click “Next”.



12. Click “Finish” to complete the installation.



B. Choosing the best resolution

Due to the technology of an LC display, it always provides a fixed resolution. For the FP563 this is a resolution of 1024x768. This is called the so-called native resolution, which also represents the maximal resolution. Lower resolutions are displayed on a full screen through an interpolation circuit. Flaws do occur with the interpolated resolution compared to the native resolution. If you want to have all the advantages of LCD technology you must use the native resolution. Using Windows 95/98/2000 you can change the resolution as follows:

1. Double-click the "**Display**" icon in the control panel.



2. From the "**Display Properties**" window, select the "**Settings**" tab. There is a slider on the right-hand side in the middle of the window. There you can alter the resolution.
3. Set a resolution of 1024x768.

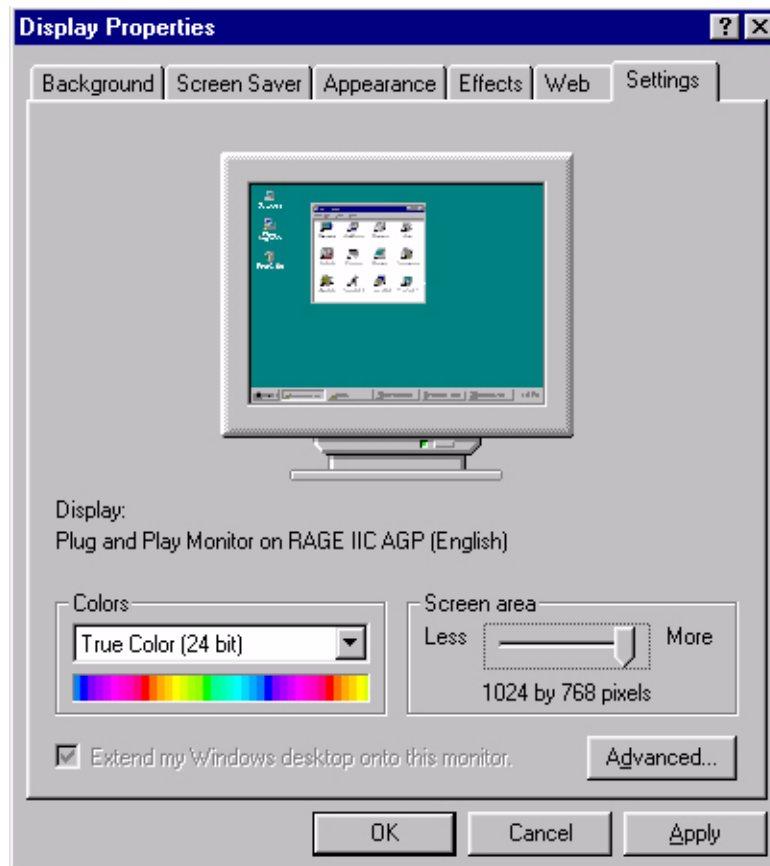

- In the subsequent windows press: "Apply", "OK" and "Yes".

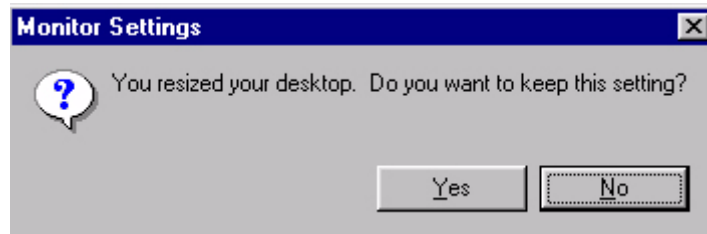
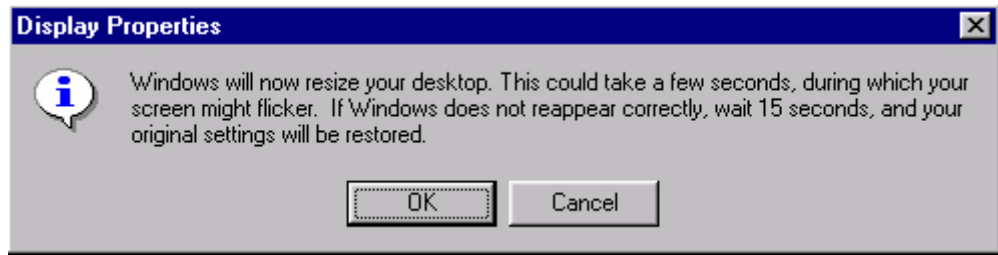

- You can now close "Display Properties".

C. Refresh Rate Selection

There is no need to choose the highest possible refresh rate on a LC display. It is not technically possible for an LC display to flicker. Even at a refresh rate of 60 Hz you will get an absolutely flicker-free image. More important is that you make sure that you use one of the factory modes. In contrast to a modern CRT monitor, which is a multiscan monitor, the display is a multi-frequency monitor. This means, the best results are only obtained by using the factory modes. You will find a table with the factory modes in this user's guide. For the native resolution of 1024x768, these, for example, are 60, 70 and 75 Hertz, not 72 Hz, however. In Windows 95/98/2000 you can change the refresh rate as follows:

1. Double click the "**Display**" icon in the control panel.

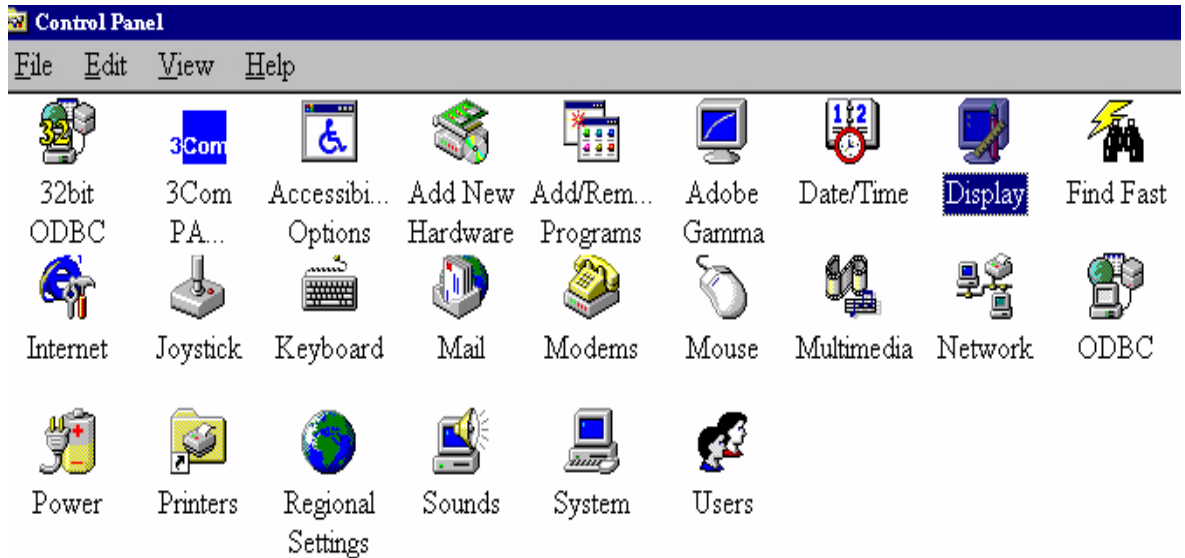

2. From the "**Display Properties**" window, select the "**Settings**" tab. Click the "**Advanced properties**" button in the bottom right corner.

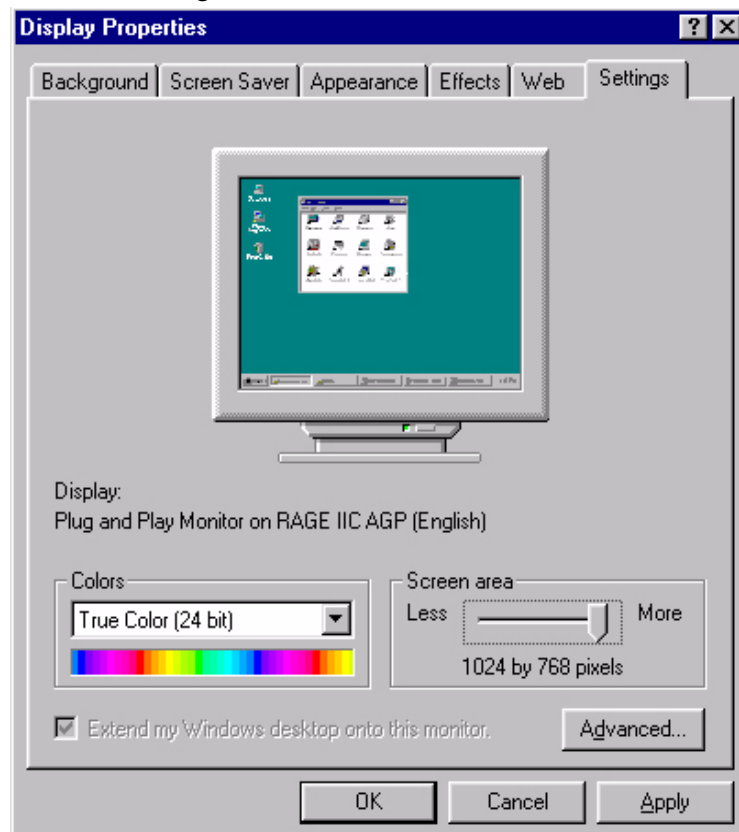

3. Select the "**Adapter**" tab. The refresh rate selection field is located in the center at the bottom of the window.

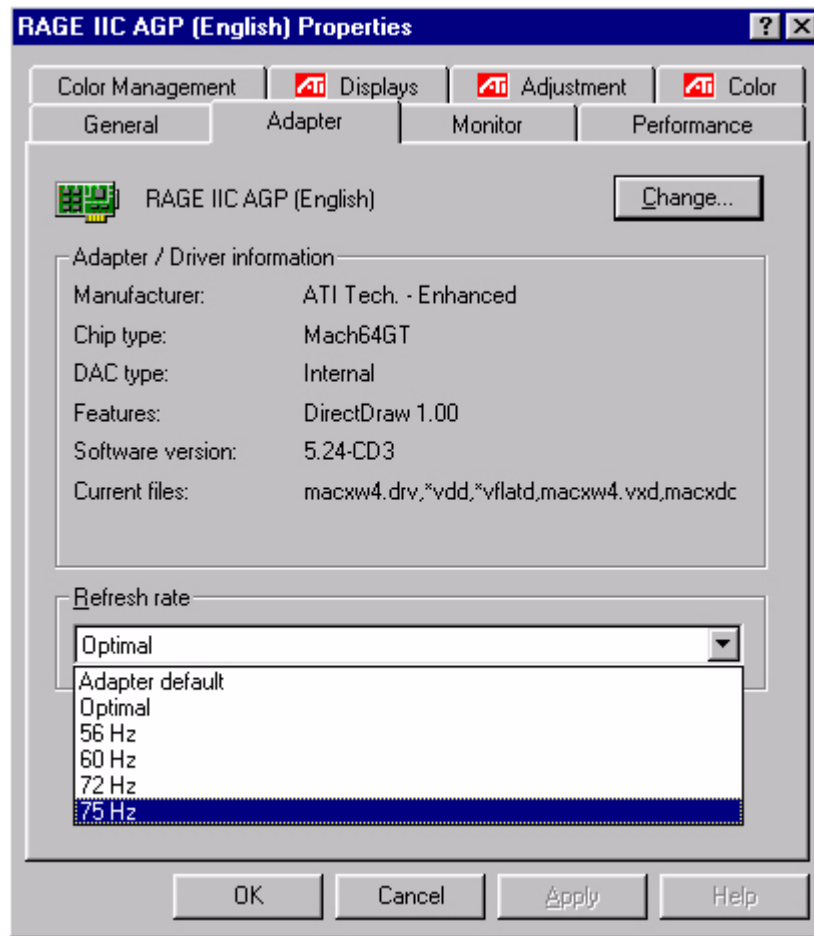

4. Choose a refresh rate from the table with the factory modes, which can be found in the user's guide, and select this in the settings field.
5. In the subsequent windows press "**Change**", "**OK**" and "**Yes**".

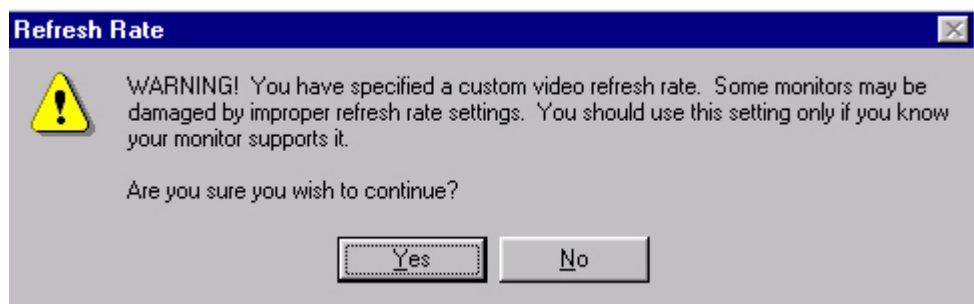

6. You can now close "**Display Properties**".

D. Picture Optimization

The easiest way to obtain an optimal picture is by using the *ikey* function. This only works reliably, if you use the supplied adjustment software (auto.exe) and if the device is being used in one of the factory modes.

1. Start the auto.exe program from the CD, supplied with the monitor. A test pattern appears.
2. Now press the *ikey*. The device carries out an automatic adjustment. In most cases optimal results will be obtained. You can quit the auto.exe with a single mouse click and clicking on "**Exit**".

If you are still not satisfied with the result, you can still attempt to enhance the image by means of manual adjust.

1. To do this restart the auto.exe test pattern, which is the best way of observing possible changes. You also can use any other image, such as the desktop of an operating system.
2. You can access the OSD menu by pressing the **Enter** button on the monitor.
3. Navigate to the submenu for the Geometry values and then press **Enter**.
4. Adjust the "**Pixel Clock**".
5. To Exit **Clock** submenu by pressing **Exit** twice (Geometry submenu).

If you need further adjustment, back to Geometry submenu and select "**Phase**". If you are still not satisfied with the result, repeat the procedure using a different refresh rate.

You must use one of the factory modes. If the *i-key* is not working, or the "**Not supported mode**" message is on the OSD you are not using one of the supported modes. If you are having difficulties generating a supported mode, ask the manufacturer of your graphics card for assistance.

Adjusting the Monitor

A Look at the Control Panel

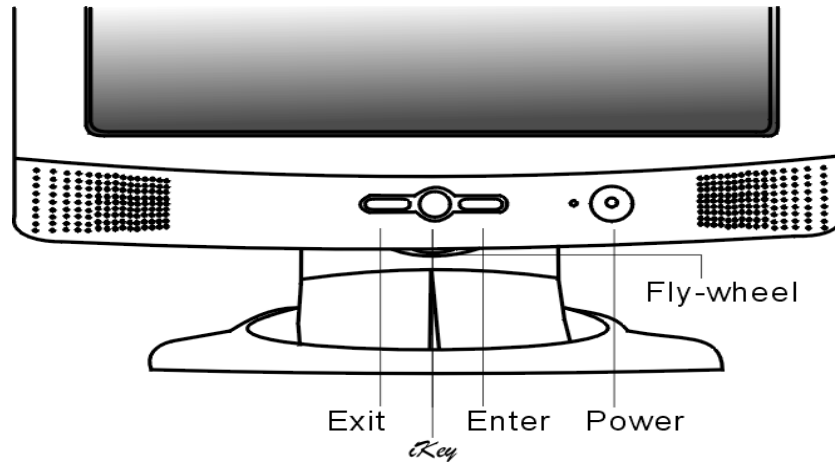

There are 4 keys & one wheel for user's control including "Power", "iKey", "Exit", "Enter" and a wheel. The following descriptions are the introduction of these keys & fly wheel.

1. "Power": Turn the power on or off.
2. "iKey": Adjust vertical position, phase, horizontal position and pixel clock automatically.
3. "Exit" key: Back to main menus, save menu or exist OSD menu without saving. Hot key for Audio volume adjustment.
4. "Enter" key: Enter sub-menus, select items or save items.
5. "Wheel": For left / right adjustment. Hot key for Brightness/Contrast adjustment.

Hot Key Mode

Contrast hot-key

<ol style="list-style-type: none"> 1. Roll the fly wheel right to enter the Contrast hot-key mode. 2. Roll the fly wheel to make adjustment. The scale can be adjust from maximum (100) to minimum(0). 3. Press the "Exit" to save and leave OSD operation. 	
--	--

Brightness hot-key

<ol style="list-style-type: none"> 1. Roll the fly wheel left to enter the Brightness hot-key mode. 2. Roll the fly wheel to make adjustment. The scale can be adjust from maximum (100) to minimum (0). 3. Press the "Exit" to save and leave OSD operation. 	
--	--

Volume hot-key

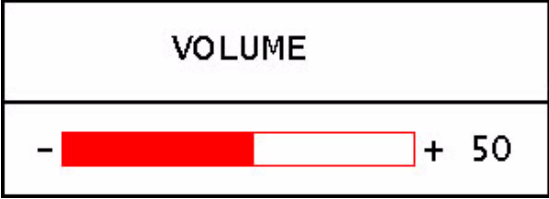
<ol style="list-style-type: none"> 1. Press "Enter" to enter Speaker Volume hot-key mode. 2. Roll the fly wheel to make adjustment. The scale can be adjust from maximum (100) to minimum (0). 3. Press the "Exit" to save and leave OSD operation. 	
--	--

Main Menu Mode

Control Functions Available in Main Menu

1. Luminance

Roll fly-wheel key to select this item and press "Enter" to enter sub-menu. There are two items for luminance adjustments.

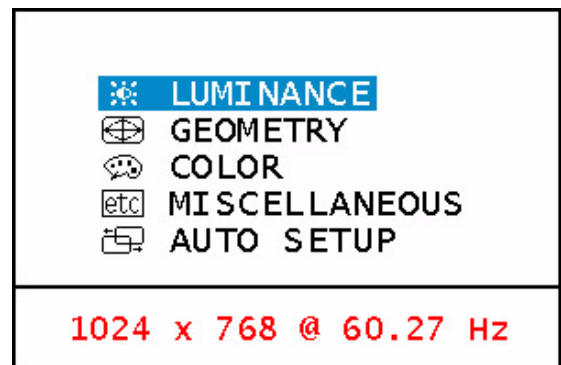

 **Brightness:** adjust the brightness of the display.

 **Contrast:** adjust the difference between the light and dark areas.

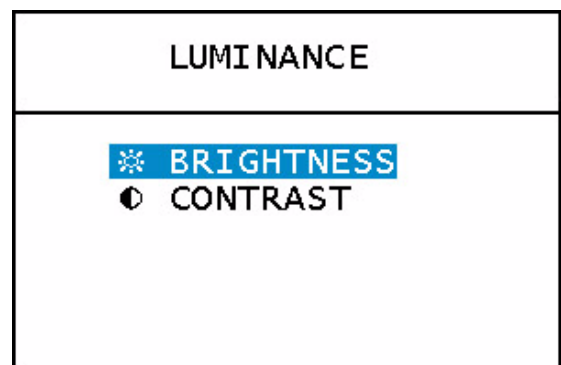

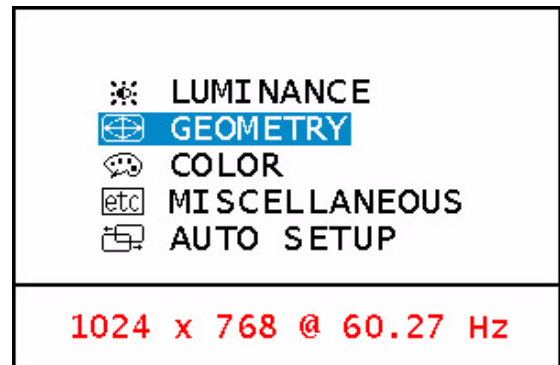

2. Geometry

Roll fly-wheel key to select this item and press “Enter” to enter sub-menu. There are four items for geometry adjustments.



 H. (Horizontal) Position: adjusts the horizontal position of the display.

 V. (Vertical) Position: adjusts the vertical position of the display.

 Phase: adjusts the phase of pixel clock.

 Pixel Clock: adjusts the frequency of the pixel.

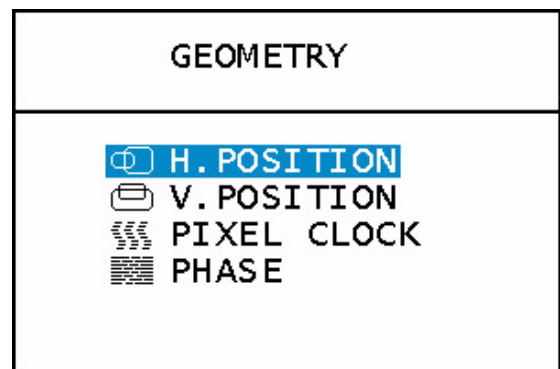

3. Color Adjustment

Roll fly-wheel key to select this item and press “Enter” to enter sub-menu. There are four items for geometry adjustments.

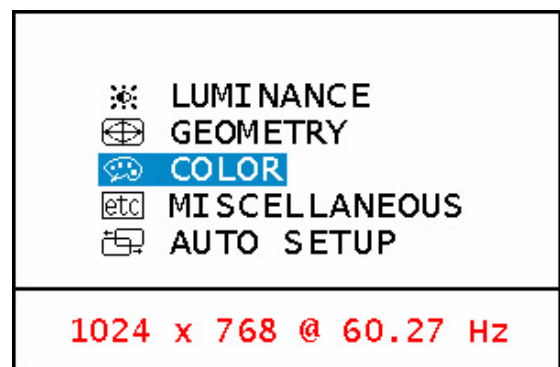

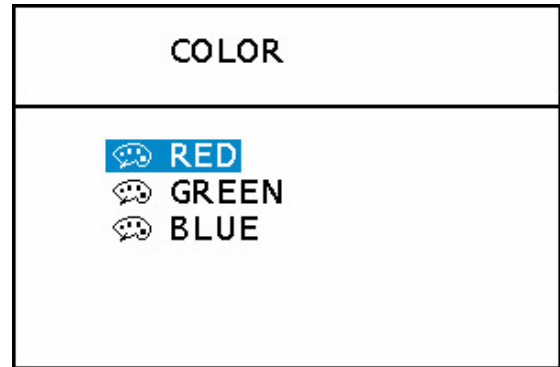

There are three items to adjust. Roll fly-wheel key to select a color and press “**Enter**” to adjust color temperature.



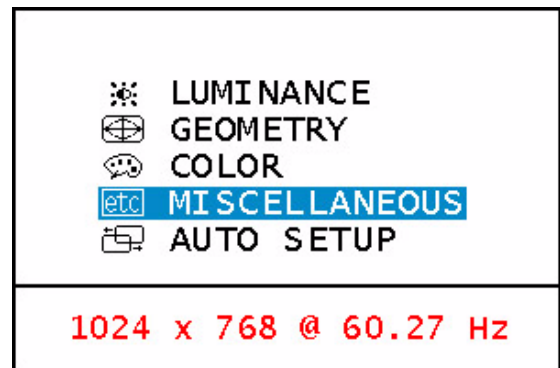

4. etc Miscellaneous

Roll fly-wheel key to select this item and press “**Enter**” to enter sub-menu. There are four items for miscellaneous.





 OSD Setting: to adjust settings of OSD.

 Language: to select OSD language.

 Information: show the display information.

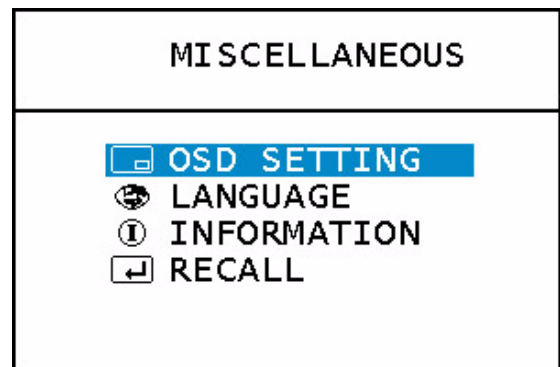
 Recall: recall to factory settings.



 H. (Horizontal) Position: adjusts the OSD horizontal position of the display.

 V. (Vertical) Position: adjusts the OSD vertical position of the display.

 OSD Time: to set the standby time of OSD.

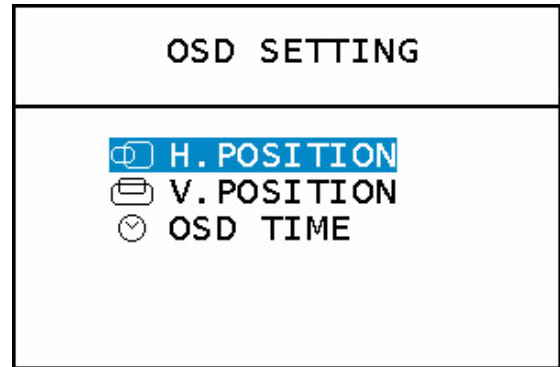

Roll fly-wheel key to select a language then press "Exit" to back to previous menu.

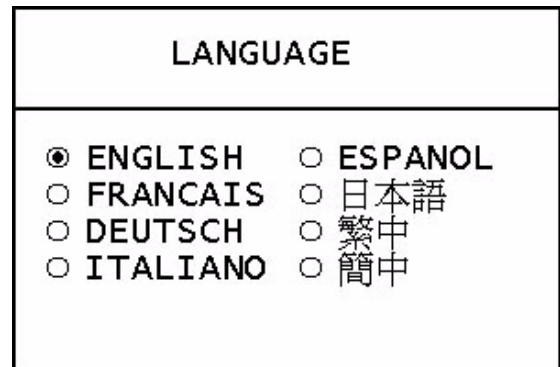

Enter "Information" sub menu the OSD display the resolution, horizontal and vertical refresh rate.

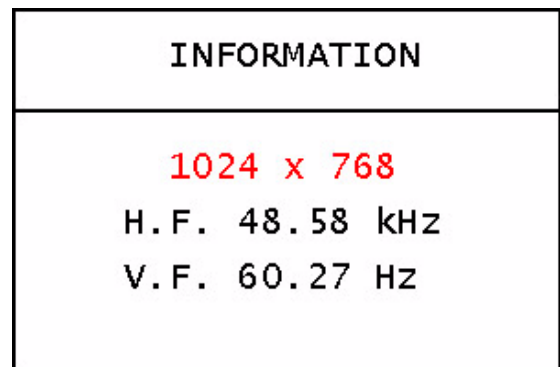

Enter "Recall" sub menu and select "Yes" to recall to factory settings.

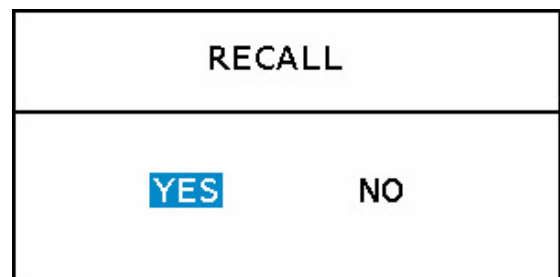

5. Auto Setup

Roll fly-wheel key to select this item and press “**Enter**” to perform auto adjustment.

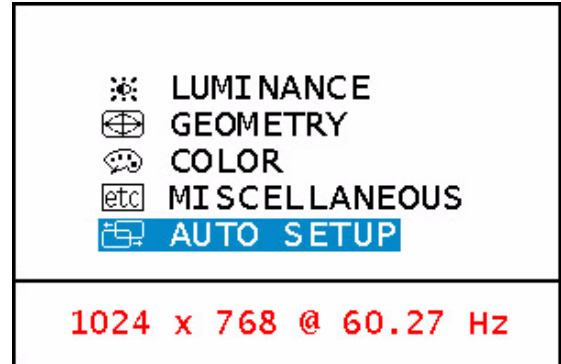

Troubleshooting

Frequently Asked Questions (FAQ)

✓ The image is blurred:

- ☞ Read the chapter, Installation/Adjustment and then select the correct resolution, refresh rate and make adjustments based on these instructions.

- ☞ Do you use a VGA extension cable?

Remove the extension cable for the test. Is the image now in focus? If not, optimize the image working on the description in the chapter, Installation/Adjustment. It is normal for blurring to occur due to conduction losses in extension cables. You can minimize these losses by using an extension cable with better conduction quality or with a built-in booster.

- ☞ Does the blurring only occur at resolutions lower than the native (maximum) resolution?

Read the chapter Installation/Adjustment. Select the native resolution.

✓ Pixel errors can be seen:

- ☞ One of several pixels are permanently black, one or more pixels are permanently white, one or more pixels are permanently red, green, blue or another colour.

Read the chapter Pixel error rates.

✓ The image has a faulty colour appearance:

- ☞ It has a yellow, blue or pink appearance.

On the monitor press the "Enter" button and using the Fly-wheel move to the "colour settings" menu. Select the "Recall" item and press "Enter". If the image is still not correct and the OSD also has a fault colour appearance, then one of the three primary colours is missing in the signal input. Now check the VGA cable contacts. If any pins are bent or broken off, then contact your dealer or read the chapter, Additional Help, Repairs & Service.

✓ No image can be seen:

- ☞ Is the prompt on the display illuminated in green?

If the LED is illuminated in green, then press the "Exit" button on the monitor to access the On Screen Display. If the message "Not supported Mode" appears there, read the chapter Installation/Adjustment.

- ☞ Is the prompt on the display illuminated in orange?

If the LED is illuminated in orange, then the power management mode is active. Press a button on the computer keyboard or move the mouse. If that does not help, then check the VGA cable contacts. If any pins are bent or broken off, then contact your dealer or read the chapter, Additional Help, Repairs & Service.

- ☞ Is the prompt on the display not illuminated at all?

Check the power supply mains socket, the external power supply and the mains switch.

✓ **The image is or distorted, flashes or flickers:**

- ☞ Read the chapter, Installation/Adjustment and then select the correct resolution, refresh rate and make adjustments based on these instructions.

✓ **The image is displaced in one direction:**

- ☞ Read the chapter, Installation/Adjustment and then select the correct resolution, refresh rate and make adjustments based on these instructions.

Need More Help?

If your problems remain after checking this manual, please contact your place of purchase or e-mail us at: DPLservice@acercm.com.tw

Supported operating modes

Incoming display mode (Input timing)				
Resolution	Horizontal Frequency (KHz)	Vertical Frequency (Hz)	Pixel Frequency (MHz)	Comment
640x350	31.47(P)	70.08(N)	25.17	DOS
720x400	31.47(N)	70.08(P)	28.32	DOS
640x480	31.47(N)	60.00(N)	25.18	DOS
640x480	37.86(N)	72.80(N)	31.50	VESA
640x480	37.50(N)	75.00(N)	31.50	VESA
800x600	35.16(P)	56.25(P)	36.00	VESA
800x600	37.88(P)	60.32(P)	40.00	VESA
800x600	48.08(P)	72.19(P)	50.00	VESA
800x600	46.87(P)	75.00(P)	49.50	VESA
1024x768	48.36(N)	60.00(N)	65.00	VESA
1024x768	56.48(N)	70.10(N)	75.00	VESA
1024x768	60.02(P)	75.00(P)	78.75	VESA

- Modes, which are not listed in the above table, may not be supported. For an optimal picture it is recommended to choose a mode listed in the table.
- You have 12 available modes compatible with Windows.
- It can happen that the image is disrupted. This can occur as a result of a signal frequency from the VGA card, which does not correspond with the usual standard. This is not, however, an error. You can improve this situation by altering an automatic setting or by manually changing the phase setting and the pixel frequency from the "Geometry" menu.
- If you switch off the monitor, interference lines can occur on your screen. But do not be concerned about this, as it is normal.
- To extend the service life of the product, we recommend that you use your computer's power management function.

Specifications

Model	FP563
FP563Display type	15.0 ",active,TFT
Viewable diagonal	38.1 cm
Native (maximum) resolution	1,024 x 768
Colors	16.7 million
Contrast / Brightness	350:1 / 250 cd/m ²
Response time	30 ms
Viewing angle (left/right, up/down)	75/75,70/70
Line frequency	31.47 - 60.02 kHzMulti- frequency monitor
Image frequency	56.25 - 75.0 Hz modes within these parameters
Image checks	Digital, Screen OSD Technology, <i>iKey</i> (automatic image setting)
Controls	mains switch, 2 buttons, one fly-wheel OSD, <i>iKey</i> .
iScreen functions	Contrast, brightness, vert. & hor. image position, phase, pixel clock, color balance, color palette, choice of language (6 language OSD), OSD position, status indicator
Microprocessor control	12 factory modes:3 DOS modes,9 VESA modes,
Power Management	VESA DPMS, EPA
max. power consumption	30 Watt Max
Power saving mode	< 3 Watt
Input signal	RGB analog 0.7 Vpp/75 Ohm positive
Synchronisation	TTL separate
Signal connection	15-pin mini D-sub cable
Temperature (operating)	5 °C - 40 °C
Air humidity (operating)	20% - 85%
Certifications	TCO 99 (Optional), TÜV/Ergonomics, CSA, TÜV/GS, IEC950, FCC Class B, DSNF, ISO 13406-2, VCCI, UL, CB Report, CE, C-Tick, BSMI
Operating voltage	Automatic switched mode power supply, 90-264 V, 47-63Hz
Dimensions (W x H x D)	380 x 383 x 186 mm
Weight	5.3 kg

Appendix: An Introduction to LCD Technology

Principles of LCD Technology

The functionality of LCD (Liquid Crystal Display) screens is based on the special physical properties of liquid crystals. Their rod shaped molecules arrange themselves similarly to the molecules of crystals - always uniformly and in one particular direction. Yet liquid crystals are not set in this orientation, but behave like a liquid: They can be manipulated by applying an electric voltage. The layers of the liquid crystal molecules can therefore be longitudinal or diagonal to the polarising direction of the light and thereby have a varying effect on the course of light waves.

LIQUID CRYSTALS POLARISE INCIDENT LIGHT

An LC display consists of two polarising filters, a control layer, the respective colour filters and the liquid crystal layer.

The light from a background lamp hits an initial polarisation membrane so that only a specific plane of polarisation of the light reaches the liquid crystal layer. Without any external electrical influence the liquid crystal molecules arrange themselves in a screw-like shape between the two vertically aligned polarising filters and the directional structure imposed as a result. The light follows this orientation and is rotated by 90 degrees. The second polarising filter only allows through light with this rotated polarisation. The light valve is open - as a result the controlled pixel lights up.

If an electrical voltage is applied, the liquid crystal molecules orientate themselves along the field lines. The 90° screw is lifted up, the LC molecules appear parallel to the incident light and allow it to pass through without altering the polarising direction. The unrotated light hits the second, rotated polarising filter and is blocked. As a result the corresponding pixel remains dark. The intensity of the departing, visible light can be controlled by means of the voltage applied to the crystal layer and the polarised light rotated to a greater or lesser extent as a result.

The TFT panel

A. The standard TFT panel

With TFT displays, also called active matrix, the light transmitting capacity of each pixel is in each case controlled by a transistor. The pixels can therefore be operated individually and addressed very quickly, which in turn guarantees perfect display even of moving images. With high-resolution LCDs well over two million pixels (three colour dots for the primary colours red, green and blue per pixel) have to be controlled. The voltage is continuously on so that the image does not have to be rebuilt constantly. The great advantage of this is that LC displays do not flicker, even when they are controlled at low refresh frequencies (e.g. at 60 Hz). Because faulty transistors can occur during production, pixel errors resulting from this are unavoidable.

B. The super TFT panel

The super TFT panel works according to the same physical principle. A significantly increased viewing angle can be created through more precise production and through slightly brighter pixels. This, however, is partly at the expense of the gray level resolution.

C. Comparison of standard and super TFT display

<i>Standard</i>	<i>Super</i>
<ul style="list-style-type: none"> • good gray level resolution • F satisfactory viewing angle 	<ul style="list-style-type: none"> • very good viewing angle • satisfactory gray level resolution

<p>Field of applications:</p> <ul style="list-style-type: none"> • Image processing • medical field • Standard workstation • Banks (confidential area) 	<p>Field of applications:</p> <ul style="list-style-type: none"> • is several people are working at one screen. • Standard workstation • Presentation tasks • Banks (public area)
--	---

Important LCD parameters

A. Viewing angle

The viewing angle is the display's visible field. If one were to imagine a vertical line in the centre of the image and to pivot up and down and to the right and to the left from that point, then that is the viewing angle. †Working ergonomically requires a viewing angle of at least 60°/60° (right/left) horizontally and 45°/45° vertically (up/down). If only two values are specified for horizontal and vertical, the values for right and left, and for horizontal and vertical are added together. If this were the case then this would provide a viewing angle of 120° horizontally and 90° vertically.

B. Contrast

Contrast is the ratio between the light intensity of the brightest and the darkest point of an image. High contrast values improve readability and ergonomics.

A display should in all instances attain contrast values of 100:1. This is a point on which LCD monitors are clearly superior to monitors.

C. Response time

The response time is the time, which a TFT cell requires to switch on and switch off. †For standard applications a response time of a maximum of 70 ms (milliseconds) is sufficient. If a more rapid image build-up is required (e.g. the multimedia field), then values of a maximum of 30 ms are required.

D. Brightness

Brightness is the emitted luminous power over a specified area. Brightness is another point, on which LCD monitors are superior to CRT devices. Traditional monitors create approx. 80 to 100 cd/m² (candela per meter square). In the case of LC displays, values below 150 cm/m² are not acceptable.

Display errors

A. Pixel errors

Pixel errors are (unfortunately) unavoidable with today's production methods, if you want to manufacture displays at an economically sensible price.

A display with a resolution of 1024x768 dots therefore has 786432 pixels. Each pixel consists of the three sub-pixels for red, green and blue. That makes 2,359,296 individual control transistors. It can occur during production that one or several transistors is defective, which means that pixel errors occur, in which a sub-pixel does not light up at all or does so all of the time.

If you were to accept the same error rate as in the case of the strip mask, for which two horizontal lines are completely disrupted, then you would end up with a 2.6 percent error rate. The accepted error rates for LC displays are far lower, however. If, for example, you were to accept a tolerance of three permitted pixel errors per display, then you would end up with an error rate of 0.0038 per thousand.

B. Blurred image

You can also end up with blurred images with LC displays indeed whenever you depart from the native resolution. A display is built for a set resolution, smaller resolutions can only be displayed interpolated. If, for example, you want to display a resolution of 800x600 on a display with a native resolution of 1024x768, then each horizontal dot would have to display 1.28 dots of the resolution. This doesn't work of course and so intermediate values are calculated and this distorts the original image.

C. Multifrequency as opposed to Multiscan

LC displays require a digital control and because currently there is still no valid standard for a digital control, for the sake of compatibility there is a tendency to revert to the standard VGA connection. This is also ideal for monitors, as they require an analog signal.

The image digitally created in the computer is converted in the graphics card into an analog signal and thus directly controls a CRT monitor. If, however, you use the analog signal of the VGA connection for a digital LC display, then transducer electronics at the input of the display must cater for conversion back into digital signals. Two problems occur with this:

1. conversion losses:

The image is not so optimal as compared with direct, digital control. It can otherwise be the case that subsequent adjustments are necessary every couple of months on a regular basis. This is generally executed via the OSD or an automatic function)

2. Limitation to specific operating modes:

Nowadays A CRT monitor is usually a multiscan monitor, which means it can be operated within the limits of its horizontal and vertical frequency, even in non-standard modes. An LCD monitor, in contrast, is a multi-frequency monitor, which means it is only guaranteed to work together with specific modes (see list in the user's guide).

Comparison of CRT & LCD monitors

<i>CRT monitor</i>	<i>Flat panel display</i>
<p>Advantages:</p> <ul style="list-style-type: none"> • <i>Multiscan monitor.</i> • <i>same quality in all resolutions.</i> • <i>proven connector standard</i> • <i>analog (infinite) colour depth</i> • <i>no pixel errors</i> • <i>also large proportions</i> • <i>inexpensive</i> <p>Disadvantages:</p> <ul style="list-style-type: none"> • <i>geometry errors possible</i> • <i>convergence errors possible</i> • <i>limited brightness and contrast values</i> • <i>only flicker-free from 72 Hz</i> • <i>sensitive to magnetic and electric fields</i> • <i>relatively high power consumption</i> • <i>high heat build-up</i> • <i>larger footprint</i> • <i>high weight</i> 	<p>Advantages:</p> <ul style="list-style-type: none"> • <i>no geometry errors</i> • <i>no convergence errors</i> • <i>excellent brightness and contrast values</i> • <i>flicker-free</i> • <i>insensitive to magnetic and electric fields</i> • <i>low power consumption</i> • <i>low heat build-up</i> • <i>small footprint</i> • <i>low weight</i> <p>Disadvantages:</p> <ul style="list-style-type: none"> • <i>Multi-frequency monitor.</i> • <i>best quality only in its native resolution.</i> • <i>Absence of standards</i> • <i>limited colour depth</i> • <i>pixel errors</i> • <i>no large proportions</i> • <i>expensive</i>

Summary

Ultimately, it cannot be said that LCD monitors are superior to CRT monitors or vice-versa either. Rather when choosing which device to use you need to weigh up the advantages and disadvantages in order to decide which technology to use.

In the public and presentational arena, LC displays are definitely preferable over CRT monitors. In relation to the display workstation order, the small footprint is also an important argument and in this respect more favours flat panel displays. On the other hand, when it comes to particular colour depth, or you need a large viewable diagonal, the choice of a CRT monitor is still unrivalled.