

# TravelMate 220/260 series

## User's guide

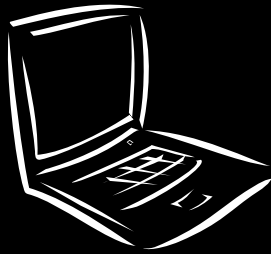

Copyright © 2001. Acer Incorporated.  
All Rights Reserved.

TravelMate 220/260 series User's guide  
Original Issue: December 2001

Changes may be made periodically to the information in this publication without obligation to notify any person of such revision or changes. Such changes will be incorporated in new editions of this manual or supplementary documents and publications. This company makes no representations or warranties, either expressed or implied, with respect to the contents hereof and specifically disclaims the implied warranties of merchantability or fitness for a particular purpose.

Record the model number, serial number, purchase date, and place of purchase information in the space provided below. The serial number and model number are recorded on the label affixed to your computer. All correspondence concerning your unit should include the serial number, model number, and purchase information.

No part of this publication may be reproduced, stored in a retrieval system, or transmitted, in any form or by any means, electronic, mechanical, photocopy, recording, or otherwise, without the prior written permission of Acer Incorporated.

TravelMate 220/260 series Notebook computer

Model Number : \_\_\_\_\_

Serial Number: \_\_\_\_\_

Purchase Date: \_\_\_\_\_

Place of Purchase: \_\_\_\_\_

Acer and the Acer logo are registered trademarks of Acer Incorporated. Other company's product names or trademarks are used herein for identification purposes only and belong to their respective companies.





# First things first

We would like to thank you for making the TravelMate series of notebook computers your choice for your mobile computing needs. We hope you will be happy with your TravelMate as much as we enjoyed making it for you.

## Your guides

To help you use your TravelMate, we have designed a set of guides:



First off, the **Just for Starters...** poster helps you get started with setting up your computer.



This **User's guide** introduces you to the many ways your computer can help you be more productive. This guide provides clear and concise information about the computer, so read it thoroughly.

If you ever need to print out a copy, this User's guide is also available in PDF (Portable Document Format). Follow these steps:

- 1 Click on **Start, Programs, TravelMate.**
- 2 Click on **TravelMate User's guide.**

**Note:** Viewing the file requires Adobe Acrobat Reader installed. If Adobe Acrobat Reader is not installed on your computer, clicking on TravelMate User's guide will run the Acrobat Reader setup program first. Follow the instructions on the screen to complete the installation. For instructions on how to use Adobe Acrobat Reader, access the **Help** menu.



A handy **Hot key pocket reference** card is useful for quick glances at functional key combinations.



An **Online guide** is your helping hand on-the-go, with easy to access, detailed and linked information about your computer.

To access the online guide:

- 1** Click on **Start, Programs, TravelMate**.
- 2** Click on **TravelMate Online guide**.



Lastly, there may be a **Read me first** sheet included with your package which contains important reminders and updates. So, please read through it.

For more information about our products, services, and support information, please visit our Web site ([global.acer.com](http://global.acer.com)).

## Basic care and tips for using your computer

### Turning your computer on and off

To turn on the computer, simply slide and then release the power switch on the left side of your TravelMate. See "Left view" on page 4 for the location of the power switch.

To turn the power off, do any of the following:

- Use the Windows shutdown command

Click on **Start, Turn Off Computer**; then click on **Turn Off**.

- Use the power switch



-----

**Note:** You can also use the power switch to perform power management functions. See "Power management" on page 23.

- Use the customized functions for power management

You can also shut down the computer by closing the display cover, or by pressing the sleep hot key (**Fn-F4**). See "Power management" on page 23.



-----

**Note:** If you cannot power off the computer normally, press and hold the power switch for more than four seconds to shut down

the computer. If you turn off the computer and want to turn it on again, wait at least two seconds before powering up.

## Taking care of your computer

Your computer will serve you well if you take care of it.

- Do not expose the computer to direct sunlight. Do not place it near sources of heat, such as a radiator.
- Do not expose the computer to temperatures below 0°C (32°F) or above 50°C (122°F).
- Do not subject the computer to magnetic fields.
- Do not expose the computer to rain or moisture.
- Do not spill water or any liquid on the computer.
- Do not subject the computer to heavy shock and vibration.
- Do not expose the computer to dust and dirt.
- Never place objects on top of the computer to avoid damaging the computer.
- Do not slam the computer display when you close it.
- Never place the computer on uneven surfaces.

## Taking care of your AC adapter

Here are some ways to take care of your AC adapter:

- Do not connect the adapter to any other device.
- Do not step on the power cord or place heavy objects on top of it. Carefully route the power cord and any cables away from personal traffic.
- When unplugging the power cord, do not pull on the cord itself but pull on the plug.
- The total ampere ratings of the equipment plugged in should not exceed the ampere rating of the cord if you are using an extension cord. Also, the total current rating of all equipment plugged into a single wall outlet should not exceed the fuse rating.

## Taking care of your battery pack

Here are some ways to take care of your battery pack:

- Use only batteries of the same kind as replacements. Turn the power off before removing or replacing batteries.

- Do not tamper with batteries. Keep them away from children.
- Dispose of used batteries according to local regulations. Recycle if at all possible.

## Cleaning and servicing

When cleaning the computer, follow these steps:

- 1** Power off the computer and remove the battery pack.
- 2** Disconnect the AC adapter.
- 3** Use a soft cloth moistened with water. Do not use liquid or aerosol cleaners.

If any of the following occurs:

- The computer has been dropped or the body has been damaged.
- Liquid has been spilled into the product.
- The computer does not operate normally.

Please refer to "Troubleshooting my computer" on page 43.



# Contents

First things first	iii
Your guides	iii
Basic care and tips for using your computer	iv
1 Getting to know your TravelMate	1
A TravelMate tour	3
Front view	3
Left view	4
Right view	5
Rear view	6
Bottom view	7
Features	8
Indicators	10
Using the keyboard	11
Special keys	11
Touchpad	17
Touchpad basics	17
Storage	19
Hard disk	19
AcerMedia drive	19
Floppy drive	21
Audio	22
Adjusting the volume	22
Power management	23
Moving around with your TravelMate	24
Disconnecting from the desktop	24
Moving around	24
Taking the computer home	25
Traveling with the computer	27
Traveling internationally with the computer	27
Securing your computer	29
Using a computer security lock	29
Using passwords	29
2 Customizing my computer	33
Expanding through options	35
AcerMedia bay modules	35
Connectivity options	35
Upgrade options	39
Using system utilities	41
Notebook Manager	41
Launch Manager	41

BIOS Utility	42
3 Troubleshooting my computer	43
Frequently-asked questions	45
Error messages	49
Requesting service	51
International Traveler's Warranty (ITW)	51
Before you call	51
Appendix A Specifications	53
Appendix B Notices	59
Index	67

# 1 Getting to know your TravelMate

Your TravelMate computer combines high-performance, versatility, power management features and multimedia capabilities with a unique style and ergonomic design. Work with unmatched productivity and reliability with your new power computing partner.

# A TravelMate tour

After setting up your computer as illustrated in the **Just for Starters...** poster, let us show you around your new TravelMate computer.

## Front view

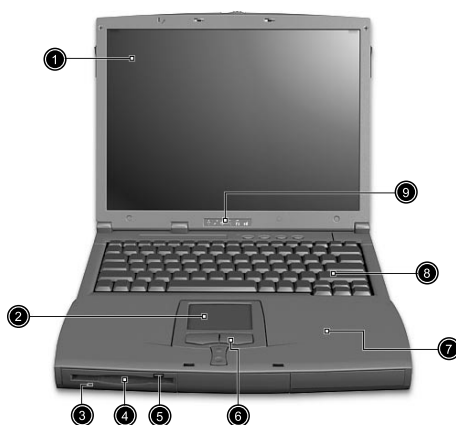



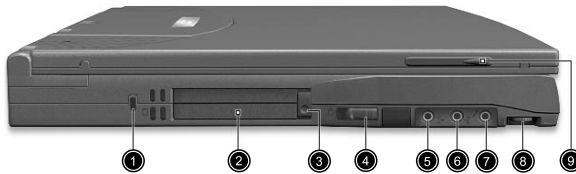

#	Item	Description
1	Display screen	Also called LCD (liquid-crystal display), displays computer output.
2	Touchpad	Touch-sensitive pointing device which functions like a computer mouse.
3	Floppy activity indicator	LED (light-emitting diode) that turns on and off when the floppy is active.
4	Floppy drive	Internal diskette drive; accepts 3.5-inch diskettes.
5	Floppy disk eject button	Push this button to eject the floppy disk.
6	Click buttons (left, center and right)	The left and right buttons function like the left and right mouse buttons; the center button serves as a scroll up/down button.

#	Item	Description
7	Palmrest	Comfortable support area for your hands when you use the computer.
8	Keyboard	Inputs data into your computer.
9	Status indicators	LEDs that turn on and off to show the status of the computer, its functions and components.

## Left view



#	Item	Description
1	Security keylock	Connects to a Kensington-compatible computer security lock.
2	PC Card slot 	Connects to one Type III or one Type II 16-bit PC Card or 32-bit CardBus PC Card.
3	Eject button	Ejects PC Card from the card slot.
4	Power switch	Turns on the computer power.
5	Speaker/Headphone-out jack 	Connects to audio line-out devices (e.g., speakers, headphones).
6	Line-in jack 	Accepts audio line-in devices (e.g., audio CD player, stereo walkman).

#	Item	Description
7	Microphone-in jack 	Accepts a mono/stereo condenser microphone.
8	Volume control	Controls the volume of the speakers.
9	Video capture kit slot	Accepts the video capture kit option on the left side of the computer.







## Right view

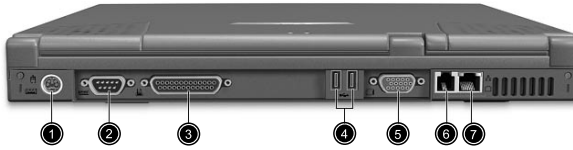

#	Item	Description
1	Video capture kit slot	Accepts the video capture kit option on the right side of the computer.
2	Battery bay	Houses the computer's battery pack.
3	AcerMedia drive	Houses removable media drive modules.
4	LED indicator	Lights up when the AcerMedia drive is active.
5	Eject button	Ejects the compact disc from the drive.
6	Emergency eject slot	Ejects the compact disc when the computer is turned off. See page 46 for more details.
7	Power jack 	Connects to an AC adapter.

## Rear view



#	Item	Description
1	PS/2 port 	Connects to any PS/2-compatible device (e.g., PS/2 keyboard/mouse/keypad).
2	Serial port 	Connects to a serial device (e.g., serial mouse).
3	Parallel port 	Connects to a parallel device (e.g., parallel printer).
4	USB ports (two) 	Connect to any Universal Serial Bus devices (e.g., USB mouse, USB camera).
5	External display port 	Connects to a display device (e.g., external monitor, LCD projector) and displays up to 64K colors at 1280x1024 resolution.
6	Modem jack 	Connects to a phone line.
7	Network jack 	Connects to an Ethernet 10/100-based network.



## Bottom view

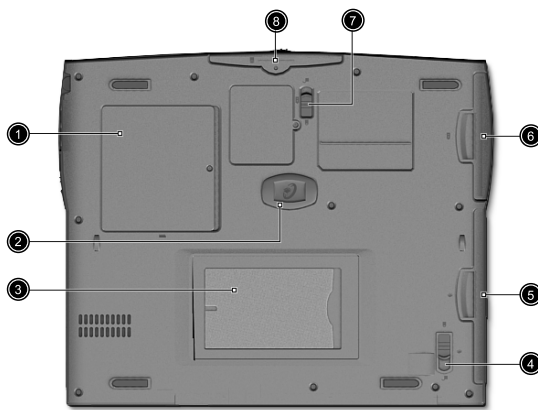

#	Item	Description
1	Memory compartment	Houses the computer's main memory.
2	Hard disk anti-shock protection	Protects your hard disk against shocks.
3	Personal identification slot	Insert a business card or similar-sized identification card to personalize your computer.
4	AcerMedia bay release latch	Unlatches the AcerMedia drive for removal or swapping.
5	AcerMedia bay	Houses an AcerMedia drive module.
6	Battery bay	Houses the computer's battery pack.
7	Battery release latch	Unlatches the battery to remove the battery pack.
8	Hard disk bay	Houses the computer's hard disk (secured by a screw).

# Features

Below is a brief summary of the computer's many features:

## Performance

- Intel® Mobile Pentium® III processor with 512 KB cache or Intel® Mobile Celeron® processor with 128 KB or 256 KB cache
- 64-bit memory bus
- AcerMedia bay (removable CD or DVD drive)
- Built-in floppy drive
- High-capacity Enhanced-IDE hard disk
- High-capacity battery pack
- Advanced Configuration Power Interface (ACPI) power management system

## Display

- Large Thin-Film Transistor (TFT) liquid crystal display (LCD) displaying 32-bit true-color at 1024x768 XGA (eXtended Graphics Array) resolution
- 3D capabilities
- Simultaneous LCD and CRT display support
- Supports other output display devices such as LCD projection panels for large-audience presentations
- "Automatic LCD dim" feature that automatically decides the best settings for your display and conserves power
- Dual display capability

## Multimedia

- 16-bit high-fidelity AC'97 stereo audio with 3D sound and wavetable synthesizer
- Built-in dual speakers
- High-speed CD or DVD drive (AcerMedia bay)

## Connectivity

- High-speed fax/data modem port

- Ethernet/Fast Ethernet port
- USB (Universal Serial Bus) ports

### Human-centric design and ergonomics

- All-in-one design (CD or DVD drive, floppy drive, and hard disk)
- Sleek, smooth and stylish design
- Full-sized keyboard
- Ergonomically-centered touchpad pointing device

### Expansion







- One Type III or one Type II CardBus PC Card (formerly PCMCIA) slot
- Upgradeable memory

# Indicators

The computer has six easy-to-read status icons below the display screen.



The Power and Sleep status icons are visible even when you close the display cover so you can see the status of the computer while the cover is closed.

Icon	Function	Description
	Power	Lights when the computer is on.
	Sleep	Lights when the computer enters Standby mode and blinks when it enters into or resumes from hibernation mode.
	Media Activity	Lights when the floppy drive, hard disk or AcerMedia drive is active.
	Battery Charge	Lights when the battery is being charged.
	Caps Lock	Lights when Caps Lock is activated.
	Num Lock	Lights when Num Lock is activated.

# Using the keyboard

The keyboard has full-sized keys and an embedded keypad, separate cursor keys, two Windows keys and twelve function keys.

## Special keys

### Lock keys

The keyboard has three lock keys which you can toggle on and off.

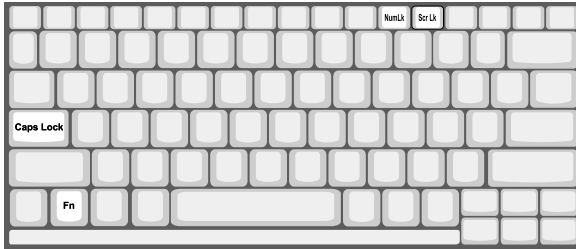

Lock key	Description
Caps Lock	When Caps Lock is on, all alphabetic characters typed are in uppercase.
Num Lock (Fn-F11)	When Num Lock is on, the embedded keypad is in numeric mode. The keys function as a calculator (complete with the arithmetic operators +, -, *, and /). Use this mode when you need to do a lot of numeric data entry. A better solution would be to connect an external keypad.
Scroll Lock (Fn-F12)	When Scroll Lock is on, the screen moves one line up or down when you press the up or down arrow keys respectively. Scroll Lock does not work with some applications.

## Embedded numeric keypad

The embedded numeric keypad functions like a desktop numeric keypad. It is indicated by small characters located on the upper right corner of the keycaps. To simplify the keyboard legend, cursor-control key symbols are not printed on the keys.



Desired access	Num lock on	Num lock off
Number keys on embedded keypad	Type numbers in a normal manner.	
Cursor-control keys on embedded keypad	Hold Shift while using cursor-control keys.	Hold Fn while using cursor-control keys.
Main keyboard keys	Hold Fn while typing letters on embedded keypad.	Type the letters in a normal manner.





**Note:** If an external keyboard or keypad is connected to the computer, the Num Lock feature automatically shifts from the internal keyboard to the external keyboard or keypad.

## Windows keys

The keyboard has two keys that perform Windows-specific functions.



Key	Description
Windows logo key 	Start button. Combinations with this key perform shortcut functions. Below are a few examples: Ⓜ + Tab (Activates next taskbar button) Ⓜ + E (Explores My Computer) Ⓜ + F (Finds Document) Ⓜ + M (Minimizes All) Shift + Ⓜ + M (Undoes Minimize All) Ⓜ + R (Displays the Run... dialog box)
Application key 	Opens a context menu (same as a right-click).

## Hot keys



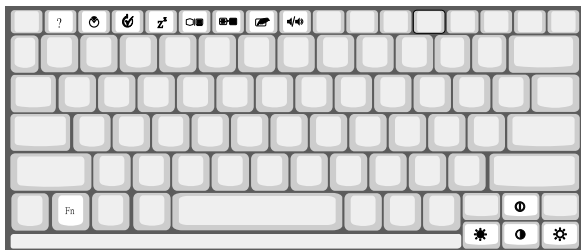

The computer employs hot keys or key combinations to access most of the computer's controls like screen brightness, volume output and the BIOS Utility.

To activate hot keys, press and hold the **Fn** key before pressing the other key in the hot key combination.



Hot key	Icon	Function	Description
Fn-F1	?	Hot Key Help	Displays help on hot keys.
Fn-F2		Setup	Accesses the computer's configuration utility.
Fn-F3		Power Management Scheme Toggle	Switches the power management scheme used by the computer (function available if supported by operating system). See the Online guide for details.
Fn-F4	Zz	Sleep	Puts the computer in Sleep mode. See the Online guide for details.
Fn-F5		Display Toggle	Switches display output between the display screen, external monitor (if connected) and both the display screen and external monitor.
Fn-F6		Screen Blank	Turns the display screen backlight off to save power. Press any key to return.



Hot key	Icon	Function	Description
Fn-F7		Touchpad Toggle	Turns the internal touchpad on and off.
Fn-F8		Speaker Toggle	Turns the speakers on and off.
Fn→		Brightness up	Increases the screen brightness.
Fn←		Brightness down	Decreases the screen brightness.
Alt Gr-Euro		Euro	Types the Euro symbol.

### The Euro symbol

If your keyboard layout is set to United States-International or United Kingdom or if you have a keyboard with a European layout, you can type the Euro symbol on your keyboard.



**Note for US keyboard users:** The keyboard layout is set when you first set up Windows. For the Euro symbol to work, the keyboard layout has to be set to United States-International.

To verify the keyboard type:

- 1 Click on **Start, Control Panel**.
- 2 Double-click on **Regional and Language Options**.
- 3 Click on the **Language** tab and click on **Details**.
- 4 Verify that the keyboard layout used for "En English (United States)" is set to United States-International.

If not, select and click on **ADD**; then select **United States-International** and click on **OK**.

- 5 Click on **OK**.

To type the Euro symbol:

- 1 Locate the Euro symbol on your keyboard.
- 2 Open a text editor or word processor.

### 3 Hold **Alt Gr** and press the Euro symbol.



Some fonts and software do not support the Euro symbol. Please refer to <http://www.microsoft.com/typography/faq/faq12.htm> for more information.

## Launch Keys

Located at the top of the keyboard are four buttons. These buttons are called launch keys. They are designated as key 1, key 2, key 3 and key 4. By default, key 1 is used to launch the Internet browser and key 2 is used to launch the email application. Keys 3 and 4 start the Launch Manager application. All four launch keys can be set by the user. To set the launch keys, run the Acer Launch Manager.



# Touchpad

The built-in touchpad is a PS/2-compatible pointing device that senses movement on its surface. This means the cursor responds as you move your finger on the surface of the touchpad. The central location on the palmrest provides optimum comfort and support.



**Note:** When using an external USB or serial mouse, you can press **Fn-F7** to disable the touchpad. If you are using an external PS/2 mouse, the touchpad is automatically disabled.



## Touchpad basics

The following items teach you how to use the touchpad:

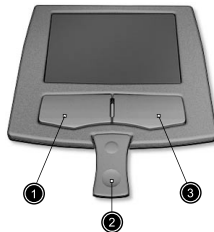

- Move your finger across the touchpad to move the cursor.
- Press the left (1) and right (3) buttons located on the edge of the touchpad to do selection and execution functions. These two buttons are similar to the left and right buttons on a mouse. Tapping on the touchpad produces similar results.
- Use the center (2) button (top and bottom) to scroll up or down a page. This button mimics your cursor pressing on the right scroll bar of Windows applications.

Function	Left button	Right button	Center buttons	Tap
Execute	Click twice quickly			Tap twice (at the same speed as double-clicking a mouse button)
Select	Click once			Tap once
Drag	Click and hold, then use finger to drag the cursor on the touchpad			Tap twice (at the same speed as double-clicking a mouse button) then hold finger to the touchpad on the second tap and drag the cursor
Access context menu		Click once		
Scroll			Click and hold the up/down button	



**Note:** Keep your fingers dry and clean when using the touchpad. Also keep the touchpad dry and clean. The touchpad is sensitive to finger movements. Hence, the lighter the touch, the better the response. Tapping harder will not increase the touchpad's responsiveness.

# Storage

This computer supplies you with the following media storage:

- High-capacity Enhanced-IDE hard disk
- AcerMedia drive
- Floppy drive

## Hard disk

The high-capacity hard disk is the answer to your storage needs. This is where your data files are stored.

## AcerMedia drive

The AcerMedia drive bay accepts a wide variety of media drive modules for use with your computer. These include the following:

- CD-ROM drive
- DVD-ROM drive
- DVD/CD-RW drive

## Ejecting the CD or DVD tray

To eject the CD or DVD tray when the computer is turned on, press the drive eject button (a); then pull out the tray.

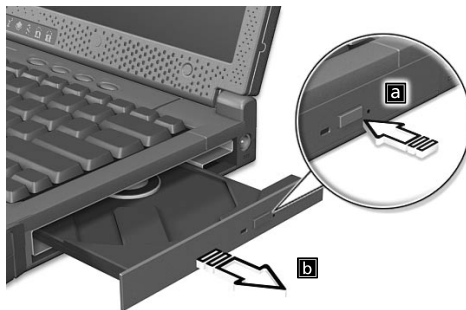

When the power is off, you can eject the drive tray using the emergency eject hole. See page 46.

## Playing DVD movies

When the DVD drive module is installed in the AcerMedia drive bay, you can play DVD movies on your computer.

- 1 Eject the DVD tray and insert a DVD movie disc; then close the DVD tray.



**Important!** When you launch the DVD player for the first time, the program asks you to input the region code. DVD discs are divided into 6 regions. Once your DVD drive is set to a region code, it will play DVD discs of that region only. You can set the region code a maximum of five times (including the first time), after which the last region code set will remain permanent. Recovering your hard disk does not reset the number of times the region code has been set. Refer to the table later in this section for DVD movie region code information.

- 2 The DVD movie will automatically play after a few seconds.

Region Code	Country or Region
1	U.S.A., Canada
2	Europe, Middle East, South Africa, Japan
3	Southeast Asia, Taiwan, Korea (South)
4	Latin America, Australia, New Zealand
5	Former U.S.S.R., parts of Africa, India
6	People's Republic of China



**Note:** To change the region code, insert a DVD movie of a different region into the DVD drive. Please refer to the online help for more information.

## Floppy drive

The internal floppy drive accepts standard 3.5-inch, 1.44 MB diskettes.

### Inserting and ejecting a diskette

Insert a diskette (label side up) into the floppy drive. Eject a diskette by pressing the floppy disk eject button (a) and pull out the diskette to remove it.

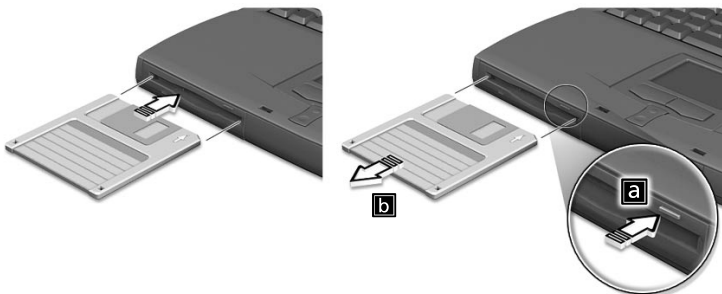

# Audio

The computer comes with 16-bit high-fidelity AC'97 stereo audio. The built-in dual stereo speakers are easy to access.



There are audio ports on the left panel of the computer. See “Left view” on page 4 for more information on external audio devices.

## Adjusting the volume

Adjusting the volume on the computer is easy with a rotary volume control knob on the left panel. Turn the knob to the left (clockwise) to increase the volume; turn it to the right (counterclockwise) to decrease the volume.





# Power management

This computer has a built-in power management unit that monitors system activity. System activity refers to any activity involving one or more of the following devices: keyboard, mouse, floppy drive, hard disk, peripherals connected to the serial and parallel ports, and video memory. If no activity is detected for a period of time (called an inactivity timeout), the computer stops some or all of these devices in order to conserve energy.

This computer employs a power management scheme that supports ACPI (Advanced Configuration and Power Interface), which allows for maximum power conservation and maximum performance at the same time. Windows handles all power-saving chores for your computer.

Refer to your online guide for more information.

# Moving around with your TravelMate

This section gives you tips and hints on things to consider when moving around or traveling with your computer.

## Disconnecting from the desktop

Follow these steps to disconnect your computer from external accessories:

- 1 Save your work in progress.
- 2 Remove any media, diskette or compact disc, from the drive(s).
- 3 Shut down the operating system.
- 4 Turn off the computer.
- 5 Close the display cover.
- 6 Disconnect the cord from the AC adapter.
- 7 Disconnect the keyboard, pointing device, printer, external monitor, and other external devices.
- 8 Disconnect the Kensington lock if you are using one to secure the computer.

## Moving around

“when you are just moving within short distances, for example, from your office desk to a meeting room”

## Preparing the computer

Before moving the computer, close and latch the display cover to place it in Sleep mode. You can now safely take the computer anywhere you go within the building. To bring the computer out of Sleep mode, open the display.

If you are taking the computer to a client's office or a different building, you may choose to shut down the computer:

- 1 Click on **Start, Turn Off Computer**.
- 2 Click on **Turn Off**.

- or -

you can put the computer in Sleep mode by pressing **Fn-F4**. Then close and latch the display.

When you are ready to use the computer again, unlatch and open the display, and press any key. If the power indicator is off, the computer has entered Hibernation mode and turned off. Press, slide and release the power switch to turn the computer back on. Note that the computer may enter Hibernation mode after a period of time it is in Sleep mode. Turn the power on to wake up the computer from Hibernation mode.

## What to bring to short meetings

A fully charged battery runs the computer for about 2.5 hours under most circumstances. If your meeting is shorter than that, you probably do not need to bring anything with you other than the computer.

## What to bring to long meetings

If your meeting will last longer than 2.5 hours or if your battery is not fully charged, you may want to bring the AC adapter with you to plug in your computer in the meeting room.

If the meeting room does not have an electrical outlet, reduce the drain on the battery by putting the computer in Sleep mode. Press **Fn-F4** or close the display cover whenever you are not actively using the computer. Then tap any key or open the display to resume.

## Taking the computer home

“when you are moving from your office to your home or vice versa”

### Preparing the computer

After disconnecting the computer from your desktop, follow these steps to prepare the computer for the trip home:

- Check if you have removed all media, diskettes and compact discs, from the drive(s). Failure to remove the media can damage the drive head.
- Pack the computer in a protective case that can prevent the computer from sliding around and cushion it if it should fall.



.....  
**Caution:** Avoid packing items next to the top cover of the computer. Pressure against the top cover can damage the screen

## What to bring with you

Unless you already have some items at home, bring the following items with you:

- AC adapter and power cord
- The printed user's manual
- AcerMedia drive module(s)

## Special considerations

Follow these guidelines to protect your computer while traveling to and from work:

- Minimize the effect of temperature changes by keeping the computer with you.
- If you need to stop for an extended period of time and cannot bring the computer with you, leave the computer in the trunk of the car to avoid exposing the computer to excessive heat.
- Changes in temperature and humidity can cause condensation. Allow the computer to return to room temperature, and inspect the screen for condensation before turning on the computer. If the temperature change is greater than 18°F (10°C), allow the computer to come to room temperature slowly. If possible, leave the computer for 30 minutes in an environment with a temperature between outside and room temperature.

## Setting up a home office

If you frequently work on your computer at home, you may want to purchase a second AC adapter for use at home. With a second AC adapter, you can avoid transporting the extra weight to and from home.

If you use your computer at home for significant periods of time, you might also want to add an external keyboard, monitor, or mouse.

## Traveling with the computer

“when you are moving within a larger distance, for instance, from your office building to a client’s office building or traveling locally”

### Preparing the computer

Prepare the computer as if you were taking it home. Make sure that the battery in the computer is charged. Airport security may require you to turn on your computer when bringing it into the gate area.

### What to bring with you

Bring the following items with you:

- AC adapter
- Spare, fully-charged battery pack(s)
- Additional printer driver files if you plan to use another printer
- AcerMedia drive module(s)

### Special considerations

In addition to the guidelines for taking the computer home, follow these guidelines to protect your computer while traveling:

- Always take the computer as carry-on luggage.
- If possible, have the computer inspected by hand. Airport security X-ray machines are safe, but do not put the computer through a metal detector.
- Avoid exposing floppy disks to hand-held metal detectors.

## Traveling internationally with the computer

“when you are moving from country to country”

### Preparing the computer

Prepare the computer as you would normally prepare it for traveling.

### What to bring with you

Bring the following items with you:

- AC adapter
- Power cords that are appropriate for the country to which you are traveling
- Spare, fully-charged battery packs
- AcerMedia drive module(s)
- Additional printer driver files if you plan to use another printer
- Proof of purchase, in case you need to show it to customs officials
- International Traveler's Warranty passport

## Special considerations

Follow the same special considerations as when traveling with the computer. In addition, these tips are useful when traveling internationally:

- When traveling in another country, check that the local AC voltage and the AC adapter power cord specifications are compatible. If not, purchase a power cord that is compatible with the local AC voltage. Do not use converter kits sold for appliances to power the computer.
- If you are using the modem, check if the modem and connector is compatible with the telecommunications system of the country you are traveling in.

## Securing your computer

Your computer is a valuable investment that you need to take care of. Learn how to protect and take care of your computer.

Security features include hardware and software locks — a security notch and passwords.

### Using a computer security lock

A security keylock notch located on the left panel of the computer lets you connect a Kensington-compatible computer security lock.



Wrap a computer security lock cable around an immovable object such as a table or locked drawer handle. Insert the lock into the notch and turn the key to secure the lock. Some keyless models are also available.

### Using passwords

Three password types protect your computer from unauthorized access. Setting these passwords creates several different levels of protection for your computer and data:

- Setup Password prevents unauthorized entry to the BIOS Utility. Once set, you must key-in this password to gain access to the BIOS Utility. See “BIOS Utility” on page 42 and your online guide for more details.
- Power-on Password secures your computer against unauthorized use. Combine the use of this password with password checkpoints on boot-up and resume from hibernation for maximum security.
- Hard Disk Password protects your data by preventing unauthorized access to your hard disk. Even if the hard disk is

removed from the computer and moved to another computer, it cannot be accessed without the Hard Disk Password.



**Important!** Do not forget your Setup and Hard Disk Password! If you forget your password, please get in touch with your dealer or an authorized service center.

## Entering passwords

When a password is set, a password prompt appears in the left-hand corner of the display screen.

- When the Setup Password is set, the following prompt appears when you press **F2** to enter the BIOS Utility at boot-up.

Setup Password  

Type the Setup Password and press **Enter** to access the BIOS Utility.

- When the Power-on Password is set, the following prompt appears at boot-up.



Type the Power-on Password (a . symbol appears for each character you type) and press **Enter** to use the computer. If you enter the password incorrectly, an **x** symbol appears. Try again and press **Enter**.

- When the Hard Disk Password is set, the following prompt appears at boot-up.



Type the Hard Disk Password (a . symbol appears for each character you type) and press **Enter** to use the computer. If you enter the password incorrectly, an **x** symbol appears. Try again and press **Enter**.



**Important!** You have three chances to enter a password. If you successfully entered the password, you are presented with a



correct entry symbol.

If you fail to enter the password correctly after three tries, the following message or symbol appears.

**Setup**  
Incorrect password specified. System disabled.

**Power-on/Hard Disk**



Slide and hold the power switch for four seconds to shut down the computer. Then turn on the computer again, and try again. If you fail to enter the Hard Disk Password, please contact your dealer or an authorized service center.

## Setting passwords

You can set passwords using:

- Notebook Manager
- BIOS Utility

See your online guide for more details.



## 2 Customizing my computer

After learning the basics of your TravelMate computer, let's get acquainted with the advanced features of your computer. In this chapter, you will learn how to add options, upgrade components for better performance, and customize your computer.

## Expanding through options

Your TravelMate offers you a complete mobile computing experience.

### AcerMedia bay modules

To swap drive modules in and out of the AcerMedia drive bay, follow these steps:

- 1 Turn your computer off.
- 2 Close the display cover.
- 3 Turn the computer over.
- 4 Slide and hold the AcerMedia drive bay release latch (a); then pull out the drive module from the AcerMedia drive bay (b).

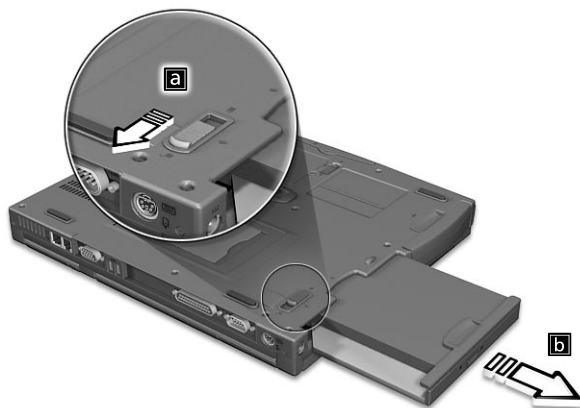

- 5 Insert a drive module into the AcerMedia drive bay. The bay release latch locks it in place.
- 6 Turn the computer over.
- 7 Open the display cover.
- 8 Turn your computer on.

### Connectivity options

Ports allow you to connect peripheral devices to your computer as you would with a desktop PC. For instructions on how to connect different

external devices to the computer, see your online guide for more details.

## Modem

Your computer has a built-in V.90 56Kbps AC'97 Link modem.



-----  
**Warning! This modem port is not compatible with digital phone lines. Plugging this modem into a digital phone line will damage the modem.**

To use the modem, connect a phone cable from the modem jack to a phone line jack.



Start your communications software program. See your communications manual for instructions.

## Network

Your computer has built-in Ethernet/Fast Ethernet capabilities. To use the network feature, connect an Ethernet cable from the network jack

to an network jack or hub. Consult your network administrator for details.



## Universal Serial Bus

The Universal Serial Bus (USB) port is a high-speed serial bus which allows you to connect and daisy-chain USB peripherals without taking up precious system resources. Your computer has two ports available.

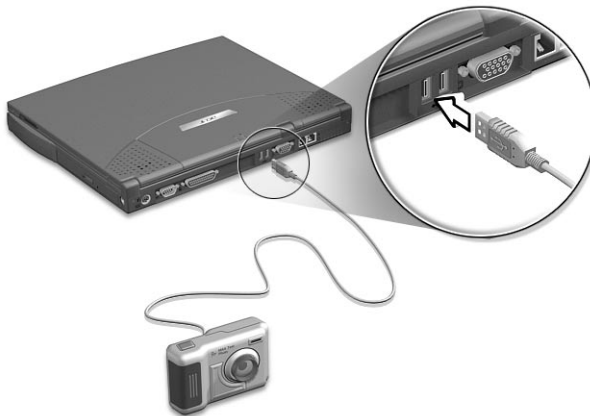

## PC Card slot

There is one Type II/Type III CardBus PC Card slot found on the left side of the computer. This slot accepts credit-card-sized cards that enhance the usability and expandability of the computer. These cards should have a PC Card logo on them.

PC Cards (formerly PCMCIA) are add-on cards for portable computers, giving you expansion possibilities long afforded by desktop PCs. Popular type III cards include flash memory, SRAM, fax/data modem, LAN and SCSI cards. CardBus improves on the 16-bit PC card technology by expanding the bandwidth to 32 bits.



.....

**Note:** Refer to your card's manual for details on how to install and use the card and its functions.

## Inserting a PC Card

Insert the card into the lower slot and make the proper connections (e.g., network cable), if necessary. See your card manual for details.



## Ejecting a PC Card

Before ejecting a PC Card:

- 1 Exit the application using the card.
- 2 Left-click on the Safely Remove Hardware icon on the taskbar and click on the PC Card item. Click **OK** to confirm.



- 3 Press the slot eject button (a) to pop out the eject button; then press it again (a) to eject the card (b).

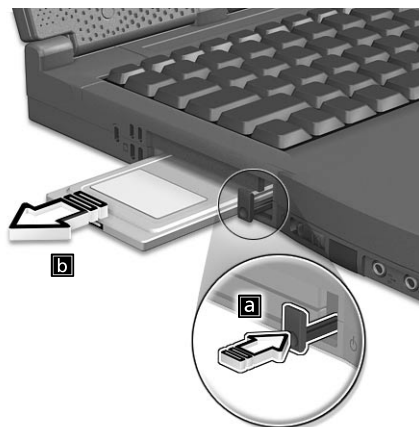

## Upgrade options

Your computer delivers superior power and performance. However, some users and the applications they use may demand more. This computer allows you to upgrade key components when you need increased performance.



**Note:** Contact your authorized dealer if you decide to perform a key component upgrade.

## Memory upgrade

Memory is expandable to 1 GB, employing 128/256/512-MB 64-bit industry standard soDIMMs (Small Outline Dual Inline Memory Modules). The computer supports SDRAM (Synchronous Dynamic Random Access Memory).

There are two memory slots on your computer, one of which is occupied by standard memory. You can upgrade memory by installing a memory module into the available slot, or replacing the standard memory with a higher-capacity memory module.

## Installing memory

Follow these steps to install memory:

- 1** Turn off the computer, unplug the AC adapter (if connected) and remove the battery pack. Then turn the computer over to access its base.
- 2** Remove the screw from the memory cover (a); then lift up and remove the memory cover (b).

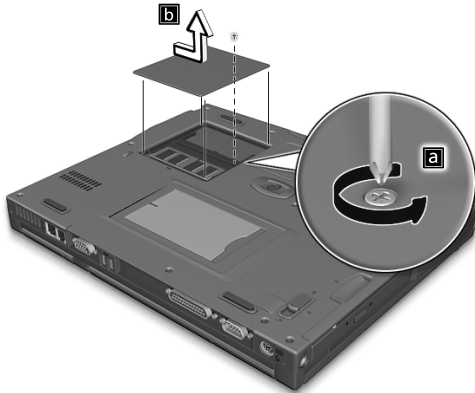

- 3** Insert the memory module diagonally into the slot (a), then gently press it down until it clicks into place (b).

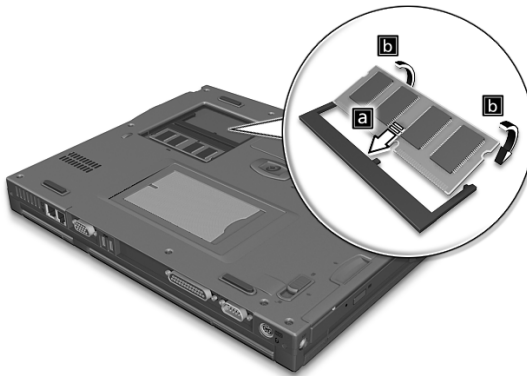

- 4** Replace the memory cover and secure it with the screw.

The computer automatically detects and reconfigures the total memory size.

# Using system utilities

## Notebook Manager

The computer has a built-in system setup program called Notebook Manager. The Windows-based Notebook Manager allows you to set passwords, the startup sequence of the drives, and power management settings. It also shows current hardware configurations.

To start the Notebook Manager, press **Fn-F2** or follow these steps:

- 1 Click on **Start, Programs, then Notebook Manager.**
- 2 Select the **Notebook Manager** application to run the program.

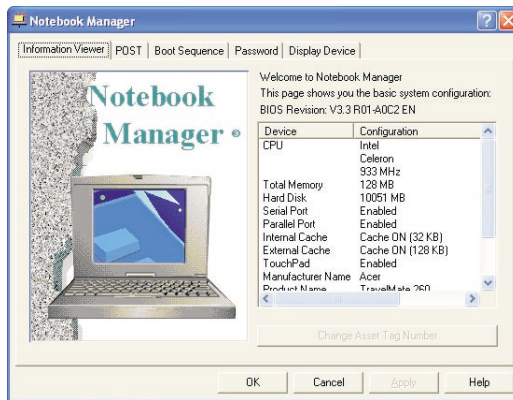

See your online guide for more information.

## Launch Manager

Launch Manager allows you to set the four launch keys located above the keyboard. See "Launch Keys" on page 16 for the location of the launch keys.

You can access the Launch Manager by clicking on **Start, Programs,** and then **Launch Manager** to start the application.

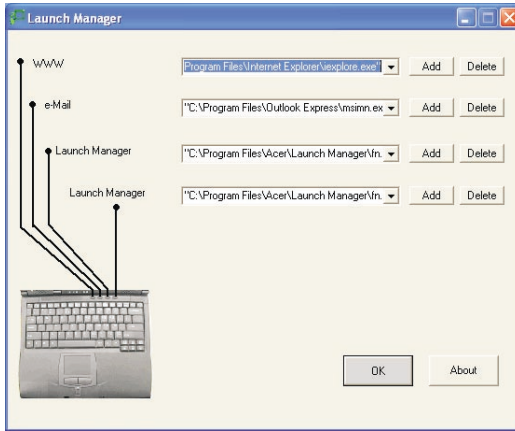

## BIOS Utility

The BIOS Utility is a hardware configuration program built into your computer's BIOS (basic input/output system).

Your computer is already properly configured and optimized, and you do not need to run this utility. However, if you encounter configuration problems, you may need to run it.

To activate the BIOS Utility, press **F2** during the POST (power-on self-test) while the TravelMate logo is being displayed. See your online guide for more information.

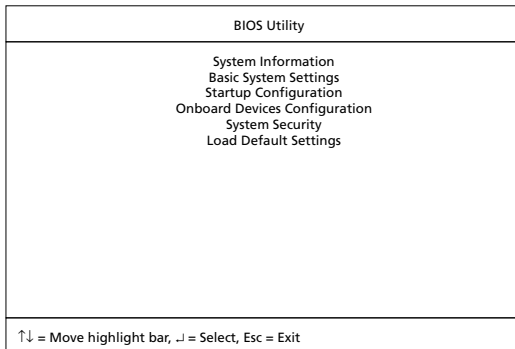

# 3 Troubleshooting my computer

This chapter instructs you on how to deal with common system problems. Read it before calling a technician if a problem occurs. Solutions to more serious problems require opening up the computer. Do not attempt to open the computer by yourself. Contact your dealer or an authorized service center for assistance.

## Frequently-asked questions

The following is a list of possible situations that may arise during the use of your computer. Easy answers and solutions are provided for each one.

I pressed the power switch and opened the display, but the computer does not start or boot-up.

Look at the Power indicator:

- If it is not lit, no power is being applied to the computer. Check the following:
  - If you are running on battery power, it may be low and unable to power the computer. Connect the AC adapter to recharge the battery pack.
  - Make sure that the AC adapter is plugged in properly to the computer and to the power outlet.
- If it is lit, check the following:
  - If the Sleep indicator is lit, the computer is in Sleep mode. Press any key or tap on the touchpad to resume.
  - Is a non-bootable (non-system) diskette in the floppy drive? Remove or replace it with a system diskette and press **Ctrl-Alt-Del** to restart the system.
- The operating system files may be damaged or missing. Insert the startup disk you created during Windows setup into the floppy drive and press **Ctrl-Alt-Del** to restart the system. This will diagnose your system and make necessary fixes.

Nothing appears on the screen.

The computer's power management system automatically blanks the screen to save power. Press any key to turn the display back on.

If pressing a key does not turn the display back on, two things might be the cause:

- The brightness level might be too low. Press **Fn→** (increase) and **Fn←** (decrease) to adjust the brightness level.
- The display device might be set to an external monitor. Press the display toggle hot key **Fn-F5** to toggle the display back to the computer.

Image is not full-screen.

Make sure that the resolution is set to 1024x768. This is the native resolution of your computer display. Right-click on your Windows desktop and select Properties to bring up the **Display Properties** dialog box. Then click on the Settings tab to make sure that the resolution is set to the appropriate resolution. Resolutions lower than the specified resolution are not full-screen on the computer or on an external monitor.

No audio is heard from the computer.

Check the following:

- The volume may be muted. In Windows, look at the volume control (speaker) icon on the taskbar. If it is crossed-out, click on the icon and deselect the Mute option.
- The speakers may be turned off. Press **Fn-F8** to turn the speakers on (this hot key also turns the speakers off).
- The volume level may be too low. In Windows, look at the volume control icon on the taskbar. You can also use the volume control knob on the left panel of the computer to adjust the volume.
- If headphones, earphones or external speakers are connected to the line-out port on the computer's right panel, the internal speakers automatically turn off.

I want to eject the CD or DVD tray without turning on the power. I cannot eject the CD or DVD tray.

There is a mechanical eject button on the CD-ROM or DVD-ROM drive. Simply insert the tip of a pen or paperclip and push to eject the tray.

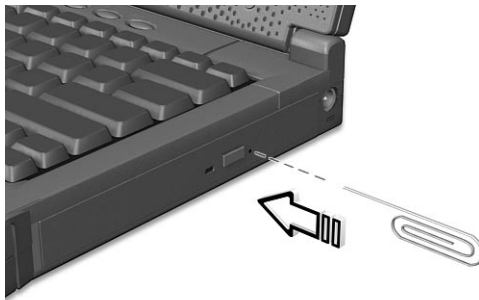



The floppy drive cannot access a diskette.

Check the following:

- Make sure the diskette is properly inserted in the floppy drive.
- Make sure the diskette is formatted.
- If the diskette is not the cause of the problem, the floppy drive may be dirty. Clean it using a drive cleaning kit. Follow the instructions included with the kit.

The CD or DVD drive cannot access a disc.

Check the following:

- Make sure the disc is supported by the drive. If your computer has a CD-ROM drive, it can read CDs but cannot read DVDs. If your computer has a DVD drive, it can read DVDs in addition to CDs.
- When placing the CD or DVD in the drive tray, make sure it is secure in the spindle on the drive tray.
- Make sure the CD or DVD is free from scratches or smudges. If the CD or DVD is dirty, clean it using a disc cleaning kit. Remember to follow the instructions included with the kit.
- If the problem does not lie with the disc, your CD or DVD drive may be dirty. Clean it using a drive cleaning kit. Follow the instructions included with the kit.

The keyboard does not respond.

Try attaching an external keyboard to the PS/2 connector on the computer's rear. If it works, contact your dealer or an authorized service center as the internal keyboard cable may be loose.

The serial mouse does not work.

Check the following:

- Make sure that the serial cable is plugged securely into the serial port.
- During the POST, press **F2** to access the BIOS Utility and verify that the serial port is enabled. See "BIOS Utility" on page 42 and your online guide for more details.

I prefer using an external keyboard and mouse, but both have PS/2

connectors and there is only one PS/2 port on the computer.

To connect two PS/2-type devices to the computer, you need to use an optional PS/2 Y-bridge connector.

The printer does not work.

Check the following:

- Make sure that the printer is connected to a power outlet and that it is turned on.
- Depending on your connection (USB or parallel), make sure that the printer cable is connected securely to the appropriate port on your computer and the corresponding port on the printer.
- During POST, press **F2** to access the BIOS Utility and verify that the parallel port is enabled if you use a parallel printer.

I want to set up my location to use the internal modem.

To properly use your communications software, you need to set up your location:

- 1** Click on **Start, Control Panel**.
- 2** Double-click on **Phone and Modem Options**.
- 3** Click on the **Dialing Rules** tab and begin setting up your location.

Refer to Windows Help and Support.

## Error messages

This notebook computer incorporates an advanced design that delivers onscreen error message reports to help you solve problems. If you receive an error message, note the message and take the corrective action. The following table lists the error messages in alphabetical order together with the recommended course of action.

Error Messages	Corrective Action
CMOS Battery Bad	Contact your dealer or an authorized service center.
CMOS Checksum Error	Contact your dealer or an authorized service center.
Disk Boot Failure	Insert a system (bootable) diskette into the floppy drive (A:), then press <b>Enter</b> to reboot.
Diskette Drive Controller Error or No Controller Present	Contact your dealer or an authorized service center.
Diskette Drive Error	Contact your dealer or an authorized service center.
Diskette Drive Type Mismatch	Press <b>F2</b> (during POST) to enter the BIOS Utility; then press <b>Esc</b> to exit and reconfigure the computer.
Equipment Configuration Error	Press <b>F2</b> (during POST) to enter the BIOS Utility; then press <b>Esc</b> to exit and reconfigure the computer.
Hard Disk 0 Error	Contact your dealer or an authorized service center.
Hard Disk 0 Extended Type Error	Contact your dealer or an authorized service center.
I/O Parity Error	Contact your dealer or an authorized service center.
Insert system diskette and press <Enter> key to reboot	Insert a system (bootable) diskette into the floppy drive (A:), then press <b>Enter</b> to reboot.

Error Messages	Corrective Action
Keyboard Error or No Keyboard Connected	Contact your dealer or an authorized service center.
Keyboard Interface Error	Contact your dealer or an authorized service center.
Memory Size Mismatch	Press <b>F2</b> (during POST) to enter the BIOS Utility; then press <b>Esc</b> to exit and reconfigure the computer.
Missing operating system	Press <b>F2</b> (during POST) to enter the BIOS Utility; then press <b>Esc</b> to exit and reconfigure the computer.
Non-system disk or disk error. Replace and strike any key when ready.	Insert a system (bootable) diskette into the floppy drive (A:), then press <b>Enter</b> to reboot.
Pointing Device Error	Contact your dealer or an authorized service center.
Pointing Device Interface Error	Contact your dealer or an authorized service center.
Protected Mode Test Fail	Contact your dealer or an authorized service center.
RAM BIOS Bad	Contact your dealer or an authorized service center.
RAM Parity Error	Contact your dealer or an authorized service center.
Real-Time Clock Error	Press <b>F2</b> (during POST) to enter the BIOS Utility; then press <b>Esc</b> to exit and reconfigure the computer.
Video RAM BIOS Bad	Contact your dealer or an authorized service center.

If you still encounter problems after going through the corrective measures, please contact your dealer or an authorized service center for assistance. Some problems may be solved using the BIOS Utility.

# Requesting service

## International Traveler's Warranty (ITW)

Your computer is backed by an International Traveler's Warranty (ITW) that gives you security and peace of mind when traveling. Our worldwide network of service centers are there to give you a helping hand.

An ITW passport comes with your computer. This passport contains all you need to know about the ITW program. A list of available, authorized service centers is in this handy booklet. Read this passport thoroughly.

Always have your ITW passport on hand, especially when you travel to receive the benefits from our support centers. Place your proof-of-purchase in the flap located inside the front cover of the ITW passport.

If the country you are traveling in does not have an Acer-authorized ITW service site, you can still get in contact with our offices worldwide.

There are three ways to access Acer for technical support and information:

- Internet service worldwide, visit [www.acersupport.com](http://www.acersupport.com)
- Telephone support in the United States and Canada, call 1-800-816-2237
- Technical support numbers in various countries

You can view a list of technical support numbers by following these steps:

- 1** Click on **Start, Control Panel**.
- 2** Double-click on **System**.
- 3** Click on the **Support Information** button.

## Before you call

Please have the following information available when you call Acer for online service, and please be at your computer when you call. With your support, we can reduce the amount of time a call takes and help solve your problems efficiently.

If there are error messages or beeps reported by your computer, write them down as they appear on the screen (or the number and sequence in the case of beeps).

You are required to provide the following information:

Name: \_\_\_\_\_

Address: \_\_\_\_\_  
\_\_\_\_\_

Telephone number: \_\_\_\_\_

Machine and model type: \_\_\_\_\_

Serial number: \_\_\_\_\_

Date of purchase: \_\_\_\_\_

Appendix A  
Specifications

This appendix lists the general specifications of your computer.



### Microprocessor

- Intel® Mobile Pentium® III processor with 512 KB cache
- or -
- Intel® Mobile Celeron® processor with 128 KB or 256 KB cache

### Memory

- Main memory expandable to 1 GB
- Dual 144-pin soDIMM socket SDRAM (Synchronous Dynamic Random Access Memory)
- 512 KB Flash ROM BIOS

### Data storage

- One 3.5-inch internal floppy drive
- One high-capacity, Enhanced-IDE hard disk
- One 5.25-inch internal removable CD-ROM, DVD-ROM or DVD/CD-RW drive (AcerMedia bay)

### Display and video

- 13.3" or 14.1" Thin-Film Transistor (TFT) liquid crystal-display (LCD) displaying 32-bit true-color at 1024x768 eXtended Graphics Array (XGA) resolution
- 3D capabilities
- Simultaneous LCD and CRT display support
- Dual display capability

### Audio

- 16-bit AC'97 stereo audio with built-in wavetable synthesizer
- Dual speakers
- Windows Sound System-compatible
- Separate audio ports for headphone-out, line-in and microphone-in devices

### Keyboard and pointing device

- 84-/85-/88-key Windows keyboard
- Ergonomically-centered touchpad pointing device with scroll function

### I/O ports

- One type II/type III PC Card slot (CardBus, PCMCIA)
- One RJ-11 phone jack (V.90, 56Kbps modem)
- One RJ-45 network jack (Ethernet 10/100BaseT)
- One DC-in jack (AC adapter)
- One parallel port (ECP/EPP compliant)
- One external monitor port
- One PS/2 keyboard/mouse port
- One speaker/headphone-out jack (3.5mm minijack)
- One audio line-in jack (3.5mm minijack)
- One microphone-in jack (3.5mm minijack)
- Two USB ports
- One 9-pin RS-232 serial port (UART16550)

### Weight and dimensions

- 3.16 kg (6.95 lbs) for 14.1" TFT model with battery and CD-ROM drive
- 311 (W) x 260.5 (D) x 36.7 (H) mm

### Environment

- Temperature
  - Operating: 5°C ~ 35°C
  - Non-operating: -10°C ~ 60°C
- Humidity (non-condensing)
  - Operating: 20% ~ 85% RH
  - Non-operating: 20% ~ 85% RH

### System

- Microsoft Windows
- ACPI support
- DMI 2.0-compliant

### Power

- Battery pack

- 4000mAh Li-Ion or 4500mAh NiMH battery pack
- 2-hour rapid charge/2.5-hour charge-in-use
- AC adapter
  - 60-Watt
  - Auto sensing 100~240Vac, 50~60Hz

#### Options

- 128-/256-/512-MB memory upgrade module
- PS/2 Y-bridge cable
- Additional AC adapter and battery pack
- External battery charger
- InviLink 802.11b wireless LAN PC card
- Lucent AP-100 802.11b Access Point



Appendix B  
Notices

This appendix lists the general notices of your computer.

## FCC notice

This device has been tested and found to comply with the limits for a Class B digital device pursuant to Part 15 of the FCC Rules. These limits are designed to provide reasonable protection against harmful interference in a residential installation. This device generates, uses, and can radiate radio frequency energy and, if not installed and used in accordance with the instructions, may cause harmful interference to radio communications.

However, there is no guarantee that interference will not occur in a particular installation. If this device does cause harmful interference to radio or television reception, which can be determined by turning the device off and on, the user is encouraged to try to correct the interference by one or more of the following measures:

- Reorient or relocate the receiving antenna
- Increase the separation between the device and receiver
- Connect the device into an outlet on a circuit different from that to which the receiver is connected
- Consult the dealer or an experienced radio/television technician for help

## Notice: Shielded cables

All connections to other computing devices must be made using shielded cables to maintain compliance with FCC regulations.

## Notice: Peripheral devices

Only peripherals (input/output devices, terminals, printers, etc.) certified to comply with the Class B limits may be attached to this equipment. Operation with non-certified peripherals is likely to result in interference to radio and TV reception.

## Caution

Changes or modifications not expressly approved by the manufacturer could void the user's authority, which is granted by the Federal Communications Commission, to operate this computer.

## Use conditions

This part complies with Part 15 of the FCC Rules. Operation is subject to the following two conditions: (1) this device may not cause harmful interference, and (2) this device must accept any interference received, including interference that may cause undesired operation.

## Notice: Canadian users

This Class B digital apparatus meets all requirements of the Canadian Interference-Causing Equipment Regulations.

## Remarque à l'intention des utilisateurs canadiens

Cet appareil numérique de la classe B respecte toutes les exigences du Règlement sur le matériel brouilleur du Canada.

## Modem notices

### FCC

This equipment complies with Part 68 of the FCC rules. Located on the bottom side of the modem is a label that contains, among other information, the FCC Registration Number and Ringer Equivalence Number (REN) for this equipment. Upon request, you must provide this information to your telephone company.

If your telephone equipment causes harm to the telephone network, the telephone company may discontinue your service temporarily. If possible, they will notify you in advance. But, if advance notice is not practical, you will be notified as soon as possible. You will also be informed of your right to file a complaint with the FCC.

Your telephone company may make changes in its facilities, equipment, operations, or procedures that could affect the proper functioning of your equipment. If they do, you will be notified in advance to give you an opportunity to maintain uninterrupted telephone service.

If this equipment should fail to operate properly, disconnect the equipment from the phone line to determine if it is causing the problem. If the problem is with the equipment, discontinue use and contact your dealer or vendor.

### CTR 21

This equipment has been approved [Council Decision 98/482/EC - "CTR 21"] for pan-European single terminal connection to the Public Switched Telephone Network (PSTN). However, due to differences between the individual PSTNs provided in different countries, the approval does not, of itself, give an unconditional assurance of successful operation on every PSTN termination point. In the event of problems, you should contact your equipment supplier in the first instance.



## Important safety instructions

Read these instructions carefully. Save these instructions for future reference.

- 1** Follow all warnings and instructions marked on the product.
- 2** Unplug this product from the wall outlet before cleaning. Do not use liquid cleaners or aerosol cleaners. Use a damp cloth for cleaning.
- 3** Do not use this product near water.
- 4** Do not place this product on an unstable cart, stand, or table. The product may fall, causing serious damage to the product.
- 5** Slots and openings in the cabinet and the back or bottom are provided for ventilation; to ensure reliable operation of the product and to protect it from overheating, these openings must not be blocked or covered. The openings should never be blocked by placing the product on a bed, sofa, rug, or other similar surface. This product should never be placed near or over a radiator or heat register, or in a built-in installation unless proper ventilation is provided.
- 6** This product should be operated from the type of power indicated on the marking label. If you are not sure of the type of power available, consult your dealer or local power company.
- 7** Do not allow anything to rest on the power cord. Do not locate this product where persons will walk on the cord.
- 8** If an extension cord is used with this product, make sure that the total ampere rating of the equipment plugged into the extension cord does not exceed the extension cord ampere rating. Also, make sure that the total rating of all products plugged into the wall outlet does not exceed the fuse rating.
- 9** Never push objects of any kind into this product through cabinet slots as they may touch dangerous voltage points or short out parts that could result in a fire or electric shock. Never spill liquid of any kind on the product.
- 10** Do not attempt to service this product yourself, as opening or removing covers may expose you to dangerous voltage points or other risks. Refer all servicing to qualified service personnel.
- 11** Unplug this product from the wall outlet and refer servicing to qualified service personnel under the following conditions:
  - a** When the power cord or plug is damaged or frayed
  - b** If liquid has been spilled into the product
  - c** If the product has been exposed to rain or water

- d** If the product does not operate normally when the operating instructions are followed. Adjust only those controls that are covered by the operating instructions since improper adjustment of other controls may result in damage and will often require extensive work by a qualified technician to restore the product to normal condition.
  - e** If the product has been dropped or the cabinet has been damaged
  - f** If the product exhibits a distinct change in performance, indicating a need for service.
- 12** Replace the battery with the same type as the product's battery we recommend. Use of another battery may present a risk of fire or explosion. Refer battery replacement to a qualified serviceman.
- 13** Warning! Batteries may explode if not handled properly. Do not disassemble or dispose of them in fire. Keep them away from children and dispose of used batteries promptly.
- 14** Use only the proper type of power supply cord set (provided in your accessories box) for this unit. It should be a detachable type: UL listed/CSA certified, type SPT-2, rated 7A 125V minimum, VDE approved or its equivalent. Maximum length is 15 feet (4.6 meters).

## Laser compliance statement

The CD or DVD drive used with this computer is a laser product. The CD or DVD drive's classification label (shown below) is located on the drive.

### CLASS 1 LASER PRODUCT

**CAUTION:** INVISIBLE LASER RADIATION WHEN OPEN. AVOID EXPOSURE TO BEAM.

### APPAREIL A LASER DE CLASSE 1 PRODUIT

**LASERATTENTION:** RADIATION DU FAISCEAU LASER INVISIBLE EN CAS D'OUVERTURE. EVITER TOUTE EXPOSITION AUX RAYONS.

### LUOKAN 1 LASERLAITE LASER KLASSE 1

**VORSICHT:** UNSICHTBARE LASERSTRAHLUNG, WENN ABDECKUNG GEÖFFNET NICHT DEM STRAHL AUSSETZEN

### PRODUCTO LÁSER DE LA CLASE I

**ADVERTENCIA:** RADIACIÓN LÁSER INVISIBLE AL SER ABIERTO. EVITE EXPONERSE A LOS RAYOS.

**ADVASEL:** LASERSTRÅLING VEDÅBNING SE IKKE IND I STRÅLEN.

VARO! LAVATTAESSA OLET ALTTINA LASERSÄTEILYLLE.

**VARNING:** LASERSTRÅLNING NÅR DENNA DEL ÅR ÖPPNAD ÅLÅ TUIJOTA SÄTEESEENSTIRRA EJ IN I STRÅLEN

**WARNING:** LASERSTRÅLNING NAR DENNA DEL ÅR ÖPPNADSTIRRA EJ IN I STRÅLEN

**ADVARSEL:** LASERSTRÅLING NAR DEKSEL ÅPNESSTIRR IKKE INN I STRÅLEN

## Lithium battery statement

### **CAUTION**

Danger of explosion if battery is incorrectly replaced. Replace only with the same or equivalent type recommended by the manufacturer. Discard used batteries according to the manufacturer's instructions.

### **ADVARSEL!**

Lithiumbatteri - Eksplosjonsfare ved feilagtig håndtering. Udsiftning må kun ske med batteri af samme fabrikat og type. Léver det brugte batteri tilbage til leverandøren.

### **ADVARSEL**

Eksplosjonsfare ved feilaktig skifte av batteri. Benytt samme batteritype eller en tilsvarende type anbefalt av apparatfabrikanten. Brukte batterier kasseres i henhold til fabrikantens instruksjoner.

### **WARNING**

Explosionsfara vid felaktigt batteribyte. Använd samma batterityp eller en ekvivalent typ som rekommenderas av apparattillverkaren. Kassera använt batteri enligt fabrikantens instruktion.

### **VAROITUS**

Päristo voi räjähtää, jos se on virheellisesti asennettu. Vaihda paristo ainoastaan laitevalmistajan suosittelemaan tyyppiin. Hävitä käytetty paristo valmistajan ohjeiden mukaisesti.

### **VORSICHT!**

Explosionsgefahr bei unsachgemäßen Austausch der Batterie Ersatz nur durch denselben oder einem vom Hersteller empfohlenem ähnlichen Typ. Entsorgung gebrauchter Batterien nach Angaben des Herstellers.

## Year 2000 compliance statement

The TravelMate 220/260 series notebook computer carries the "Hardware NSTL Tested Year 2000 Compliant" logo, which certifies that this model has been tested by NSTL using the YMark2000 test, and has been found to meet NSTL's standards for Year 2000 hardware compliance.



For more details, check the Acer Year 2000 Resource Center Web site (<http://global.acer.com/service/pcy2000.html>)

## LCD pixel statement

The LCD unit is produced with high-precision manufacturing techniques. Nevertheless, some pixels may occasionally misfire or appear as black or red dots. This has no effect on the recorded image and does not constitute a malfunction.

## Macrovision copyright protection notice

This product incorporates copyright protection technology that is protected by method claims of certain U.S. patents and other intellectual property rights owned by Macrovision Corporation and other rights owners. Use of this copyright protection technology must be authorized by Macrovision Corporation, and is intended for home and other limited viewing uses only unless otherwise authorized by Macrovision Corporation. Reverse engineering or disassembly is prohibited.

Apparatus Claims of U.S. Patent Nos. 4,631,603, 4,577,216, 4,819,098, and 4,907,093 licensed for limited viewing uses only.

# Index

## A

- AC adapter
  - caring for v
- AcerMedia drive 19
  - installing and removing 35
  - swapping 35
- audio 22
  - adjusting the volume 22
  - troubleshooting 46

## B

- battery pack
  - caring for v
  - charging indicator 10
- BIOS utility 42
- brightness
  - hotkeys 15

## C

- caps lock 11
  - on indicator 10
- care
  - AC adapter v
  - battery pack v
  - computer v
- CD
  - troubleshooting 47
- CD-ROM
  - ejecting 19
  - ejecting manually 46
  - troubleshooting 46
- cleaning
  - computer vi
- computer
  - bringing to meetings 25
  - caring for v
  - cleaning vi
  - disconnecting 24
  - features 3, 8
  - indicators 10
  - keyboards 11
  - moving around 24
  - on indicator 10
  - performance 8

- security 29
- setting up a home office 26
- taking home 25
- traveling internationally 27
- traveling on local trips 27
- troubleshooting 44
- turning off iv

## D

- diskette
  - ejecting 21
  - inserting 21
- display
  - hotkeys 14
  - troubleshooting 45, 46
- DVD 20
  - troubleshooting 47
- DVD movies
  - playing 20

## E

- error messages 49
- Ethernet 36
- Euro 15

## F

- FAQ. See frequently-asked questions
- floppy drive
  - troubleshooting 47
- frequently-asked questions 45
- front view 3

## H

- hard disk 19
- help
  - online manual iv
  - online services 51
- Hibernation mode
  - hotkey 14
- hotkeys 13

## I

- indicator lights 10
- ITW. See warranty

## K

- keyboard 11
  - embedded numeric keypad 12
  - hotkeys 13
  - lock keys 11

- troubleshooting 47
- Windows keys 13

**L**

- LEDs 10

**M**

- media access
  - on indicator 10
- memory
  - installing 40
  - upgrading 39
- messages
  - error 49
- modem 36
- mouse
  - troubleshooting 47

**N**

- network 36
- Notebook Manager 41
  - hotkey 14
- notice
  - DVD copyright protection 66
  - year 2000 compliance 66
- num lock 11
  - on indicator 10
- numeric keypad
  - embedded 12
  - num lock 12

**O**

- online services 51
- options
  - memory upgrade 39

**P**

- password 29
  - types 29
- PC Card 38
  - ejecting 38
  - inserting 38
- ports 35
- POST (power-on self-test) 42
- printer
  - troubleshooting 48
- problems 45
  - CD 47
  - CD-ROM 46

- diskette 47
- display 45, 46
- DVD 47
- floppy drive 47
- keyboard 47
- printer 48
- serial mouse 47
- startup 45
- troubleshooting 44

**Q**

- questions
  - multiple PS/2 devices 48
  - setting location for modem use 48

**S**

- safety
  - CD-ROM 64
  - FCC notice 61
  - general instructions 63
  - modem notices 62
- scroll lock 11
- security
  - keylock 29
  - passwords 29
- service
  - when to call vi
- speakers
  - hotkey 15
  - troubleshooting 46
- specifications 54
- Standby mode
  - hotkey 14
  - status indicator 10
- status indicators 10
- storage 19
  - AcerMedia drive 19
  - hard disk 19
- support
  - information 51

**T**

- touchpad 17
  - hotkey 15
  - using 17– 18
- travel
  - international flights 27
  - local trips 27

troubleshooting 44  
tips 49

**U**

universal serial bus 37

**V**

view  
front 4  
left 4

rear 6

right 5

volume

adjusting 22

**W**

warranty

International Traveler's Warrant-  
ty 51

Windows keys 13