

TravelMate 340 series

User's guide



Copyright © 1999. Acer Incorporated.
All Rights Reserved.

TravelMate 340 series User's guide
Part No. 49.40F01.001
Original Issue: September 1999

Changes may be made periodically to the information in this publication without obligation to notify any person of such revision or changes. Such changes will be incorporated in new editions of this manual or supplementary documents and publications. This company makes no representations or warranties, either expressed or implied, with respect to the contents hereof and specifically disclaims the implied warranties of merchantability or fitness for a particular purpose.

Record the model number, serial number, purchase date, and place of purchase information in the space provided below. The serial number and model number are recorded on the label affixed to your computer. All correspondence concerning your unit should include the serial number, model number, and purchase information.

No part of this publication may be reproduced, stored in a retrieval system, or transmitted, in any form or by any means, electronic, mechanical, photocopy, recording, or otherwise, without the prior written permission of Acer Incorporated.

TravelMate 340 series Notebook Computer

Model Number : _____

Serial Number: _____

Purchase Date: _____

Place of Purchase: _____

Acer and the Acer logo are registered trademarks of Acer Incorporated. Other company's product names or trademarks are used herein for identification purposes only and belong to their respective companies.



Notices	vii
Preface	xiii
Connecting the computer	xiii
Getting help and support	xv
Care and maintenance	xvii
1 Getting familiar with your computer	1
Features	3
Display	5
Indicators	7
Keyboard	8
Special keys	8
Keyboard ergonomics	13
Touchpad	14
Touchpad basics	14
Storage	16
Hard disk	16
EasyLink Combo Drive	16
Ports	20
Left port	20
Rear ports	21
Right ports	24
Audio	27
Adjusting the volume	27
Enabling the 3D effect feature	27
Securing your computer	29
Security keylock notch	29
Passwords	29
2 Operating on battery power	33
Battery pack	35
Battery pack characteristics	35
Using a battery pack for the first time	35
Replacing the battery pack	36
Charging the battery	37
Checking the battery level	38
Optimizing battery life	38
Battery-low warning	39
Power management	41
Power management modes	42
Setting power management schemes	44

Contents

3 Peripherals and options	45
External monitor	47
Setting up dualview	47
Printer	48
External pointing device	49
External PS/2 mouse	49
External serial mouse	49
External USB mouse	50
External keyboard and keypad	51
Audio devices	52
PC Cards	53
USB devices	54
USB video capture kit - option	54
Mobile jacket	55
Miscellaneous options	56
Key component upgrades	58
Memory upgrade	58
Hard disk upgrade	59
4 Moving with your computer	61
Disconnecting from the desktop	63
Moving around	64
Preparing the computer	64
What to bring to short meetings	64
What to bring to long meetings	64
Taking the computer home	66
Preparing the computer	66
What to bring with you	66
Special considerations	66
Setting up a home office	67
Traveling with the computer	68
Preparing the computer	68
What to bring with you	68
Special considerations	68
Traveling internationally with the computer	69
Preparing the computer	69
What to bring with you	69
Special considerations	69
5 Software	71
Sleep Manager	74
Accessing the Sleep Manager	74

Sleep Manager functions	76
Notebook Manager	79
Information Viewer	80
POST	81
Boot Sequence	82
Password	83
Power Management	85
Display Device	87
BIOS Utility	88
Using the BIOS Utility	88
System Information	89
Basic System Settings	91
Startup Configuration	92
Onboard Devices Configuration	93
System Security	95
Power Management	97
Load Default Settings	98
6 Troubleshooting	99
Frequently-Asked Questions	101
Troubleshooting tips	105
Using PC-Doctor	105
Online services	106
Before you call	106
Error messages	107
Appendix A Specifications	109
Index	115

Notices

FCC notice

This device has been tested and found to comply with the limits for a Class B digital device pursuant to Part 15 of the FCC Rules. These limits are designed to provide reasonable protection against harmful interference in a residential installation. This device generates, uses, and can radiate radio frequency energy and, if not installed and used in accordance with the instructions, may cause harmful interference to radio communications.

However, there is no guarantee that interference will not occur in a particular installation. If this device does cause harmful interference to radio or television reception, which can be determined by turning the device off and on, the user is encouraged to try to correct the interference by one or more of the following measures:

- Reorient or relocate the receiving antenna
- Increase the separation between the device and receiver
- Connect the device into an outlet on a circuit different from that to which the receiver is connected
- Consult the dealer or an experienced radio/television technician for help

Notice: Shielded cables

All connections to other computing devices must be made using shielded cables to maintain compliance with FCC regulations.

Notice: Peripheral devices

Only peripherals (input/output devices, terminals, printers, etc.) certified to comply with the Class B limits may be attached to this equipment. Operation with non-certified peripherals is likely to result in interference to radio and TV reception.

Caution

Changes or modifications not expressly approved by the manufacturer could void the user's authority, which is granted by the Federal Communications Commission, to operate this computer.

Use conditions

This part complies with Part 15 of the FCC Rules. Operation is subject to the following two conditions: (1) this device may not cause harmful interference, and (2) this device must accept any interference received, including interference that may cause undesired operation.

Notice: Canadian users

This Class B digital apparatus meets all requirements of the Canadian Interference-Causing Equipment Regulations.

Remarque à l'intention des utilisateurs canadiens

Cet appareil numérique de la classe B respecte toutes les exigences du Règlement sur le matériel brouilleur du Canada.

Modem notices

FCC

This equipment complies with Part 68 of the FCC rules. Located on the bottom side of the modem is a label that contains, among other information, the FCC Registration Number and Ringer Equivalence Number (REN) for this equipment. Upon request, you must provide this information to your telephone company.

If your telephone equipment causes harm to the telephone network, the telephone company may discontinue your service temporarily. If possible, they will notify you in advance. But, if advance notice is not practical, you will be notified as soon as possible. You will also be informed of your right to file a complaint with the FCC.

Your telephone company may make changes in its facilities, equipment, operations, or procedures that could affect the proper functioning of your equipment. If they do, you will be notified in advance to give you an opportunity to maintain uninterrupted telephone service.

If this equipment should fail to operate properly, disconnect the equipment from the phone line to determine if it is causing the problem. If the problem is with the equipment, discontinue use and contact your dealer or vendor.

CTR 21

This equipment has been approved [Council Decision 98/482/EC - "CTR 21"] for pan-European single terminal connection to the Public Switched Telephone Network (PSTN). However, due to differences between the individual PSTNs provided in different countries, the approval does not, of itself, give an unconditional assurance of successful operation on every PSTN termination point. In the event of problems, you should contact your equipment supplier in the first instance.

Important safety instructions

Read these instructions carefully. Save these instructions for future reference.

1. Follow all warnings and instructions marked on the product.

2. Unplug this product from the wall outlet before cleaning. Do not use liquid cleaners or aerosol cleaners. Use a damp cloth for cleaning.
3. Do not use this product near water.
4. Do not place this product on an unstable cart, stand, or table. The product may fall, causing serious damage to the product.
5. Slots and openings in the cabinet and the back or bottom are provided for ventilation; to ensure reliable operation of the product and to protect it from overheating, these openings must not be blocked or covered. The openings should never be blocked by placing the product on a bed, sofa, rug, or other similar surface. This product should never be placed near or over a radiator or heat register, or in a built-in installation unless proper ventilation is provided.
6. This product should be operated from the type of power indicated on the marking label. If you are not sure of the type of power available, consult your dealer or local power company.
7. Do not allow anything to rest on the power cord. Do not locate this product where persons will walk on the cord.
8. If an extension cord is used with this product, make sure that the total ampere rating of the equipment plugged into the extension cord does not exceed the extension cord ampere rating. Also, make sure that the total rating of all products plugged into the wall outlet does not exceed the fuse rating.
9. Never push objects of any kind into this product through cabinet slots as they may touch dangerous voltage points or short out parts that could result in a fire or electric shock. Never spill liquid of any kind on the product.
10. Do not attempt to service this product yourself, as opening or removing covers may expose you to dangerous voltage points or other risks. Refer all servicing to qualified service personnel.
11. Unplug this product from the wall outlet and refer servicing to qualified service personnel under the following conditions:
 - a. When the power cord or plug is damaged or frayed
 - b. If liquid has been spilled into the product
 - c. If the product has been exposed to rain or water
 - d. If the product does not operate normally when the operating instructions are followed. Adjust only those controls that are covered by the operating instructions since improper adjustment of other controls may result in damage and will often require extensive work by a qualified technician to restore the product to normal condition.
 - e. If the product has been dropped or the cabinet has been damaged
 - f. If the product exhibits a distinct change in performance, indicating a need for service.

12. Replace the battery with the same type as the product's battery we recommend. Use of another battery may present a risk of fire or explosion. Refer battery replacement to a qualified serviceman.
13. Warning! Batteries may explode if not handled properly. Do not disassemble or dispose of them in fire. Keep them away from children and dispose of used batteries promptly.
14. Use only the proper type of power supply cord set (provided in your accessories box) for this unit. It should be a detachable type: UL listed/CSA certified, type SPT-2, rated 7A 125V minimum, VDE approved or its equivalent. Maximum length is 15 feet (4.6 meters).

Laser compliance statement

The CD-ROM or DVD-ROM drive used with this computer is a laser product. The CD-ROM or DVD-ROM drive's classification label (shown below) is located on the drive.

CLASS 1 LASER PRODUCT

CAUTION: INVISIBLE LASER RADIATION WHEN OPEN. AVOID EXPOSURE TO BEAM.

APPAREIL A LASER DE CLASSE 1 PRODUIT

LASERATTENTION: RADIATION DU FAISCEAU LASER INVISIBLE EN CAS D'OUVERTURE. EVITER TOUTE EXPOSITION AUX RAYONS.

LUOKAN 1 LASERLAITE LASER KLASSE 1

VORSICHT: UNSICHTBARE LASERSTRAHLUNG, WENN ABDECKUNG GEÖFFNET NICHT DEM STRAHL AUSSETZEN

PRODUCTO LÁSER DE LA CLASE 1

ADVERTENCIA: RADIACIÓN LÁSER INVISIBLE AL SER ABIERTO. EVITE EXPONERSE A LOS RAYOS.

ADVARSEL: LASERSTRÅLING VED ÅBNING SE IKKE IND I STRÅLEN.

VARO! LAVATTAESSA OLET ALTTIIN LASERSÄTEILYLLE.

VARNING: LASERSTRÅLNING NÅR DENNA DEL ÅR ÖPPNAD ÅLÅ TUIJOTA SÄTEESEENSTIRRA EJ IN I STRÅLEN

VARNING: LASERSTRÅLNING NAR DENNA DEL ÅR ÖPPNADSTIRRA EJ IN I STRÅLEN

ADVARSEL: LASERSTRÅLING NAR DEKSEL ÅPNESSTIRR IKKE INN I STRÅLEN

Lithium battery statement

CAUTION

Danger of explosion if battery is incorrectly replaced. Replace only with the same or equivalent type recommended by the manufacturer. Discard used batteries according to the manufacturer's instructions.

ADVARSEL!

Lithiumbatteri - Eksplosionsfare ved fejlagtig håndtering. Udsiftning må kun ske med batteri af samme fabrikat og type. Léver det brugte batteri tilbage til leverandøren.

ADVARSEL

Ekspløsjonsfare ved feilaktig skifte av batteri. Benytt samme batteritype eller en tilsvarende type anbefalt av apparatfabrikanten. Brukte batterier kasseres i henhold til fabrikantens instruksjoner.

VARNING

Explosionsfara vid felaktigt batteribyte. Använd samma batterityp eller en ekvivalent typ som rekommenderas av apparattillverkaren. Kassera använt batteri enligt fabrikantens instruktion.

VAROITUS

Päristo voi räjähtää, jos se on virheellisesti asennettu. Vaihda paristo ainoastaan laitevalmistajan suosittelemaan tyyppiin. Hävitä käytetty paristo valmistajan ohjeiden mukaisesti.

VORSICHT!

Explosionsgefahr bei unsachgemäßen Austausch der Batterie Ersatz nur durch denselben oder einem vom Hersteller empfohlenem ähnlichen Typ. Entsorgung gebrauchter Batterien nach Angaben des Herstellers.

Year 2000 compliance statement

The TravelMate 340 series notebook computer carries the "Hardware NSTL Tested Year 2000 Compliant" logo, which certifies that this model has been tested by NSTL using the YMark2000 test, and has been found to meet NSTL's standards for Year 2000 hardware compliance.



For more details, check the Acer Year 2000 Resource Center Web site (www.acer.com.tw/service/y2k)

Macrovision copyright protection notice

This product incorporates copyright protection technology that is protected by method claims of certain U.S. patents and other intellectual property rights owned by Macrovision Corporation and other rights owners. Use of this copyright protection technology must be authorized by Macrovision Corporation, and is intended for home and other limited viewing uses only unless otherwise authorized by Macrovision Corporation. Reverse engineering or disassembly is prohibited.

Preface

This manual describes features of the TravelMate 340 series notebook computers. This series of ultra-slim computers incorporate such features as CardBus, 16-bit PCI stereo audio, Fast Infrared, internal 56K modem, internal pointing device with scroll function, Universal Serial Bus, and Accelerated Graphics Port.

This manual should answer most of the questions you have about the day-to-day operation of your TravelMate notebook computer.

Use the **Just for Starters...** instructions that came with your computer to get your computer running for the first time.

You should also take advantage of the online help files that are available with almost all of the programs shipped with your computer.

We hope you enjoy your TravelMate computer. With proper care, your computer will provide you with years of productive service.

Connecting the computer

Connecting the computer is as easy as 1-2-3.

1. Gently insert the battery into the battery bay by following the guide symbols on both the battery and the bottom of the computer; then slide the battery in until it clicks into place. The battery release latch locks.

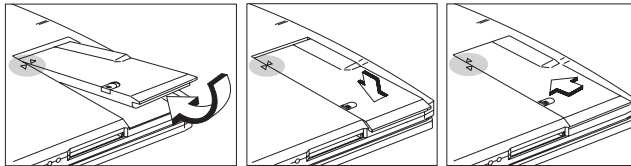

Note: When using a battery pack for the first time, fully recharge the battery, then disconnect the adapter to use up the battery before recharging again. You only need to do this once with a new battery.

2. Connect one end of the AC adapter to the DC-in jack on the rear of the computer and the other end to a power outlet.

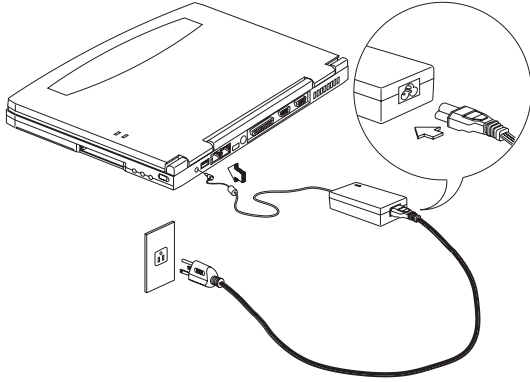

3. Slide the display cover latch to the left to open the display. Slide the power switch towards the rear of the computer then release it to turn on the power. The POST (Power On Self-Test) routine executes and Windows begins loading.

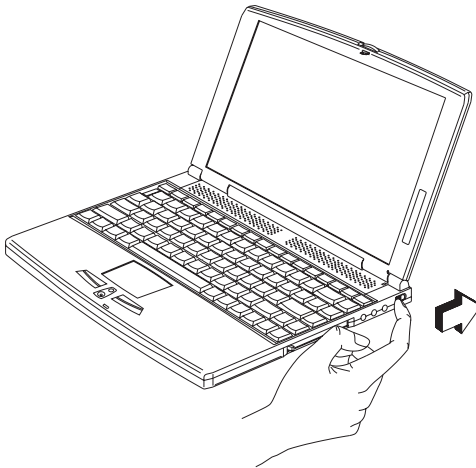

Turning off the computer

There are a number of ways you can turn the power off.

- Using the Windows **Shut Down...** command
Click on **Start, Shut Down...**, and select Shut down; then click on **OK**.
- Using the power switch



.....

Note: You can also use the power switch to perform power management functions. See “Setting advanced features in power management” on page 86.

- Using customized functions for power management

You can also shutdown the computer by closing the display cover, or by pressing the sleep hot key (**Fn-F4**). See “Setting advanced features in power management” on page 86.



.....

Note: If you cannot power off the computer normally, press and hold the power switch for more than four seconds to shut down the computer. If you turn off the computer and want to turn it on again, wait at least two seconds before powering up.

Getting help and support

This user’s guide provides clear and concise information about the computer, so read it thoroughly. To provide you with help when traveling, the computer also has a comprehensive online documentation.

Accessing the online guide

To access the online guide, follow these steps:

1. Press the Windows logo button or click on the **Start** button.
2. Select **Programs**, then click on **TravelMate**.
3. Click on **TravelMate Online Guide**.

The online guide is easy to navigate with hypertext and hypergraphics. Clear illustrations help describe notebook operation as well.

Accessing the user's guide

This printed user's guide is also available in PDF format which may come in handy if you need to print out a copy. Viewing the file requires Adobe Acrobat Reader installed.

Follow these steps:

1. Click on **Start, Programs, TravelMate.**
2. Click on **TravelMate User's Guide.**



Note: If Adobe Acrobat Reader is not installed on your computer, clicking on Travelmate User's Guide will run the Acrobat Reader setup program first. Follow the instructions on the screen to complete the installation.

For instructions on how to use Adobe Acrobat Reader, access the **Help** menu.

Support information

Your computer is backed by an International Traveler's Warranty (ITW) that gives you security and peace of mind when traveling. Our worldwide network of service centers are there to give you a helping hand.

An ITW passport comes with your computer. This passport contains all you need to know about the ITW program. A list of available, authorized service centers are in this handy booklet. Read this passport thoroughly.

Always have your ITW passport on hand, especially when you travel to receive the benefits from our support centers. Place your proof-of-purchase in the flap located inside the front cover of the ITW passport.

If the country you are traveling in does not have an Acer-authorized ITW service site, you can still get in contact with our offices worldwide.

For technical assistance and support in the United States and Canada, you can call 1-800-816-2237. You can also contact a local dealer or distributor in the country you are traveling in for assistance.



Note: For more information, see "Online services" on page 106.

If you are connected to the Internet and have World Wide Web access, visit our Web site (www.acer.com) and get an updated list of our worldwide offices, as well as information about our products.

Care and maintenance

Taking care of your computer

Your computer will serve you well if you take care of it.

- Do not expose the computer to direct sunlight. Do not place near sources of heat, such as a radiator.
- Do not expose the computer to temperatures below 0°C (32°F) or above 50°C (122°F).
- Do not subject the computer to magnetic fields.
- Do not expose the computer to rain or moisture.
- Do not spill water or any liquid on the computer.
- Do not subject the computer to heavy shock and vibration.
- Do not expose the computer to dust and dirt.
- Never place objects on top of the computer to avoid damaging the computer.
- Never place the computer on uneven surfaces.
- When holding the computer, keep your fingers away from the battery release latch, as you may inadvertently release the battery pack from the computer.

These care and maintenance tips also apply to the EasyLink Combo Drive when possible.

Taking care of your AC adapter

Here are some ways to take care of your AC adapter:

- Do not connect the adapter to any other device.
- Do not step on the power cord or place heavy objects on top of it. Carefully route the power cord and any cables away from personal traffic.
- When unplugging the power cord, do not pull on the cord itself but pull on the plug.
- The total ampere ratings of the equipment plugged in should not exceed the ampere rating of the cord if you are using an extension cord. Also, the total current rating of all equipment plugged into a single wall outlet should not exceed the fuse rating.

Taking care of your battery pack

Here are some ways to take care of your battery pack:

- Use only batteries of the same kind as replacements (Model# BTP-25D1). Turn the power off before removing or replacing batteries.
- Do not tamper with batteries. Keep them away from children.
- Dispose of used batteries according to local regulations. Recycle if at all possible.

Cleaning and servicing

When cleaning the computer, follow these steps:

1. Power off the computer and remove the battery pack.
2. Disconnect the AC adapter.
3. Use a soft cloth moistened with water. Do not use liquid or aerosol cleaners.

Contact your dealer or see your service technician if any of the following occurs:

- The computer has been dropped or the body has been damaged.
- Liquid has been spilled into the product.
- The computer does not operate normally.



1 Getting familiar with your computer

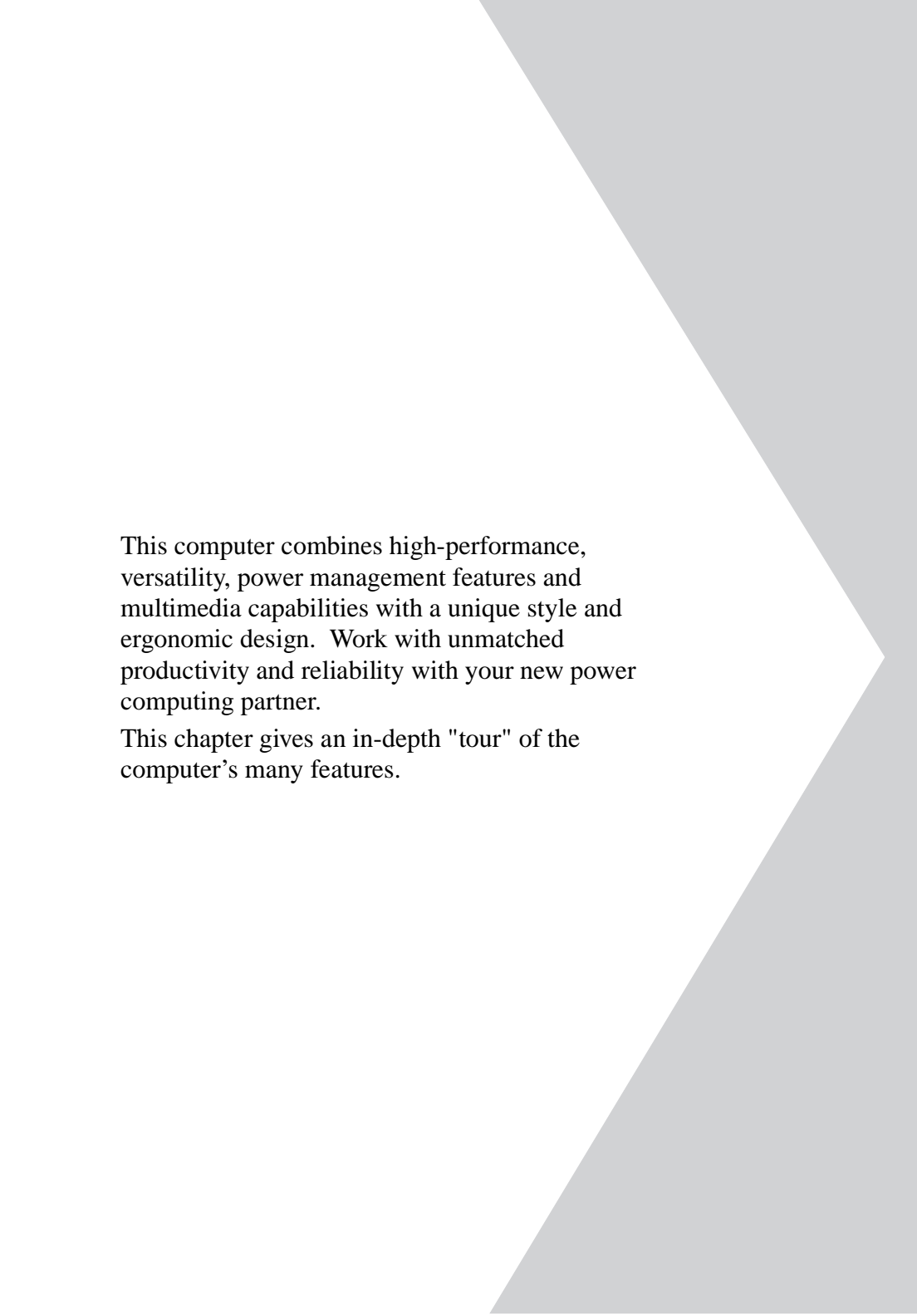

This computer combines high-performance, versatility, power management features and multimedia capabilities with a unique style and ergonomic design. Work with unmatched productivity and reliability with your new power computing partner.

This chapter gives an in-depth "tour" of the computer's many features.

► Features

This computer was designed with the user in mind. Here are just a few of its many features:

Performance

- Intel Pentium® III processor with integrated L2 cache memory
- 64-bit main memory
- Large and vibrant Thin-Film-Transistor (TFT) SVGA Liquid Crystal Display (LCD)
- 64-bit graphics acceleration with 2.5MB graphics memory and Accelerated Graphics Port (AGP)
- High-capacity, Enhanced-IDE removable hard disk
- External EasyLink™ Combo Drive (floppy drive + CD-ROM)
- Lithium-Ion battery pack
- Power management system with ACPI (Advanced Configuration and Power Interface) or APM (Advanced Power Management) support

Multimedia

- 16-bit high-fidelity PCI stereo audio with 3D sound and wavetable synthesizer
- Built-in speaker
- EasyLink™ Combo Drive
- Dualview capability
- DVD playback capability (with DVD-equipped EasyLink DVD Combo Drive option)
- USB video capture kit

Connectivity

- High-speed fax/data PCI modem
- Built-in network feature for Ethernet 10/100 LAN — optional
- Fast infrared (FIR) wireless communication
- Universal Serial Bus (USB) port

Human-centric design and ergonomics

- Ultra-slim, sleek, smooth and stylish design
- Full-sized keyboard
- Wide and curved palm rest
- Ergonomically-centered touchpad pointing device with scroll function
- Stylish cover accessory

Expansion

- CardBus PC Card (formerly PCMCIA) slot (one type II/I) with Zoomed Video (ZV) support
- Upgradeable memory and hard disk

► Display

The large graphics display offers excellent viewing, display quality and desktop performance graphics. The computer supports a Thin-Film Transistor (TFT) liquid crystal display (LCD) displaying 32-bit true-color at 800x600 Super Video Graphics Array (SVGA) resolution.

Video performance

PCI local bus video with 64-bit graphics acceleration and 2.5MB high-speed Synchronous Dynamic Random Access Memory (SDRAM) boost video performance. The video also includes 3D capabilities such as Goraud shading, and Z-buffering, as well as DVD playback support.

Simultaneous display

The computer's large display and multimedia capabilities are great for giving presentations. If you prefer, you can also connect an external monitor when giving presentations. This computer supports simultaneous LCD and CRT display. Simultaneous display allows you to control the presentation from your computer and at the same time face your audience. You can also connect other output display devices such as LCD projection panels for large-audience presentations.

Power management

The power management system incorporates an "automatic LCD dim" feature that automatically decides the best settings for your display and at the same time conserves power. See "Power management" on page 41 for more information on power management features.

Dualview

The computer's video chip takes advantage of Windows 98's multi-display capability, allowing you to extend your desktop to an external display device, such as an external monitor or projector. With this feature enabled, you can move program windows to and from the computer LCD and external display device. For more information, see "Setting up dualview" on page 47.

Opening and closing the display

To open the display, slide the display cover latch to the left and lift up the cover. Then tilt it to a comfortable viewing position. The computer employs a

microswitch that turns off the display (and enters Standby mode) to conserve power when you close the display cover, and turns it back on when you open the display cover.



Note: If an external monitor is connected, the computer turns off the display (but does not enter standby mode) when you close the display cover.

To close the display cover, fold it down gently until the display cover latch clicks into place.







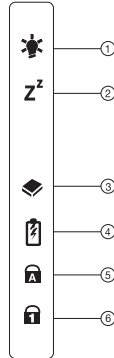

Caution: To avoid damaging the display, do not slam it when you close it. Also, do not place any object on top of the computer when the display is closed.

► Indicators

The computer has six easy-to-read status icons on the right of the display screen.



The Power and Sleep status icons are visible even when you close the display cover so you can see the status of the computer while the cover is closed.

#	Icon	Function	Description
1		Power	Lights when the computer is on.
2		Sleep	Lights when the computer enters Sleep mode.
3		Media Activity	Lights when the floppy drive, hard disk or EasyLink™ Combo Drive is active.
4		Battery Charge	Lights when the battery is being charged.
5		Caps Lock	Lights when Caps Lock is activated.
6		Num Lock	Lights when Num Lock is activated.

Keyboard

The keyboard has full-sized keys and an embedded keypad, separate cursor keys, two Windows keys and twelve function keys.

Special keys

Lock keys

The keyboard has three lock keys which you can toggle on and off.



Lock key	Description
Caps Lock	When Caps Lock is on, all alphabetic characters typed are in uppercase.
Num Lock (Fn-F11)	When Num Lock is on, the embedded keypad is in numeric mode. The keys function as a calculator (complete with the arithmetic operators +, -, *, and /). Use this mode when you need to do a lot of numeric data entry. A better solution would be to connect an external keypad.
Scroll Lock (Fn-F12)	When Scroll Lock is on, the screen moves one line up or down when you press the up or down arrow keys respectively. Scroll Lock does not work with some applications.

Embedded numeric keypad

The embedded numeric keypad functions like a desktop numeric keypad. It is indicated by small characters located on the upper right corner of the keycaps. To simplify the keyboard legend, cursor-control key symbols are not printed on the keys.

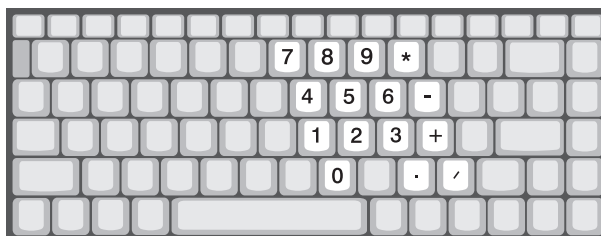

Desired access	Num lock on	Num lock off
Number keys on embedded keypad	Type numbers in a normal manner.	
Cursor-control keys on embedded keypad	Hold Shift while using cursor-control keys.	Hold Fn while using cursor-control keys.
Main keyboard keys	Hold Fn while typing letters on embedded keypad.	Type the letters in a normal manner.









Note: If an external keyboard or keypad is connected to the computer, the Num Lock feature automatically shifts from the internal keyboard to the external keyboard or keypad.

Windows keys

The keyboard has two keys that perform Windows-specific functions.



Key	Description
Windows logo key	<p>Start button. Combinations with this key perform shortcut functions. Below are a few examples:</p> <ul style="list-style-type: none">  + Tab (Activates next taskbar button)  + E (Explores My Computer)  + F (Finds Document)  + M (Minimizes All) <p>Shift +  + M (Undoes Minimize All)</p> <p> + R (Displays the Run... dialog box)</p>
Application key	Opens a context menu (same as a right-click).







Hot keys

The computer employs hot keys or key combinations to access most of the computer's controls like screen brightness, volume output and the BIOS Utility.

To activate hot keys, press and hold the **Fn** key before pressing the other key in the hot key combination.



Hot key	Icon	Function	Description
Fn-F1	?	Hot Key Help	Displays help on hot keys.
Fn-F2		Setup	Accesses the computer's configuration utility.
Fn-F3		Power Management Scheme Toggle	Switches the power management scheme used by the computer (function available if supported by operating system) See "Setting power management schemes" on page 44.
Fn-F4	Z ^Z	Sleep (ACPI) or Standby (APM)	Puts the computer in Sleep mode or Standby mode. See "Sleep mode" on page 42.
Fn-F5		Display Toggle	Switches display output between the display screen, external monitor (if connected) and both the display screen and external monitor.
Fn-F6		Screen Blank	Turns the display screen backlight off to save power. Press any key to return.
Fn-F7		Touchpad Toggle	Turns the internal touchpad on and off.

Hot key	Icon	Function	Description
Fn-F8		Speaker Toggle	Turns the speakers on and off.
Fn-←		Brightness Down	Decreases the screen brightness.
Fn-→		Brightness Up	Increases the screen brightness.
Fn-↑		Volume Up	Increases the volume.
Fn-↓		Volume Down	Decreases the volume.
Alt Gr-Euro		Euro	Types the euro symbol.

The euro symbol

If your keyboard layout is set to United States-International or United Kingdom or if you have a keyboard with a European layout, you can type the Euro symbol on your keyboard.



Note for US keyboard users: The keyboard layout is set when you first set up Windows. For the Euro symbol to work, the keyboard layout has to be set to United States-International.

To verify the keyboard type:

1. Click on **Start, Settings, Control Panel**.
2. Double-click on **Keyboard**.
3. Click on the **Language** tab.
4. Verify that the keyboard layout used for "En English (United States)" is set to United States-International.

If not, select and click on **Properties**; then select **United States-International** and click on **OK**.

5. Click on **OK**.

To type the Euro symbol:

1. Locate the Euro symbol on your keyboard.
2. Open a text editor or word processor.
3. Hold **Alt Gr** and press the Euro symbol.



Some fonts and software do not support the Euro symbol. Please refer to <http://www.microsoft.com/typography/faq/faq12.htm> for more information.

Keyboard ergonomics

Located below the keyboard, the wide and curved palm rest is ergonomically designed to provide you with a very comfortable place to rest your hands while you type.



► Touchpad

The built-in touchpad is a PS/2-compatible pointing device that senses movement on its surface. This means the cursor responds as you move your finger on the surface of the touchpad. The central location on the palm rest provides optimum comfort and support.



Note: When using an external mouse, you can press **Fn-F7** to disable the internal touchpad. If you want to use an external PS/2 mouse, first enable the touchpad, connect the external PS/2 mouse, then disable the touchpad if necessary.

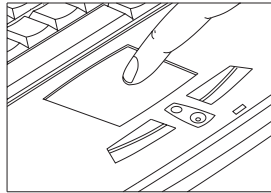

The touchpad also has scroll functions with the center buttons.

Touchpad basics

The following items teach you how to use the touchpad:

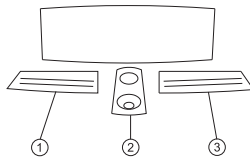

- Move your finger across the touchpad to move the cursor.
- Press the left (1) and right (3) buttons located on the edge of the touchpad to do selection and execution functions. These two buttons are similar to the left and right buttons on a mouse. Tapping on the touchpad produces similar results.
- Use the center (2) buttons (top and bottom) to scroll up or down a page. This button mimics your cursor pressing on the right scroll bar of Windows applications.

Function	Left button	Right button	Center buttons	Tap
Execute	Click twice quickly			Tap twice (at the same speed as double-clicking a mouse button)
Select	Click once			Tap once
Drag	Click and hold, then use finger to drag the cursor on the touchpad			Tap twice (at the same speed as double-clicking a mouse button) then hold finger to the touchpad on the second tap and drag the cursor
Access context menu		Click once		
Scroll			Click and hold the up/down buttons	



Note: Keep your fingers dry and clean when using the touchpad. Also keep the touchpad dry and clean. The touchpad is sensitive to finger movements. Hence, the lighter the touch, the better the response. Tapping harder will not increase the touchpad's responsiveness.

Customizing the center button

You can customize the function of the center button as follows:

1. Click on **Start, Settings, Control Panel**.
2. Double-click on **Mouse**.
3. Click on the **Button Actions** tab.
4. Customize the settings for Rocker Switch.
5. Click on **OK**.

► Storage

This computer supplies you with all-in-one media storage:

- High-capacity Enhanced-IDE hard disk
- External EasyLink™ Combo Drive
 - Standard 3.5-inch floppy drive.
 - High-speed CD-ROM drive or DVD-ROM drive (EasyLink DVD Combo Drive)

Hard disk

The removable hard disk module can be upgraded when you need more storage space. See “Hard disk upgrade” on page 59.

EasyLink Combo Drive

The EasyLink Combo Drive is a two-in-one floppy/CD-ROM or floppy /DVD-ROM “combo” drive that connects externally to the computer.

The floppy drive reads and writes standard 3.5-inch diskettes. The CD-ROM or DVD-ROM drive provides the latest in multimedia in a mobile world.

Connecting and disconnecting the EasyLink Combo Drive

To connect the EasyLink Combo Drive:

1. Pull out the EasyLink Combo Drive cable connector from its storage slot.
2. Open the EasyLink Combo Drive connector door on the computer.

3. Firmly connect the EasyLink Combo Drive (connector to connector) to the computer.

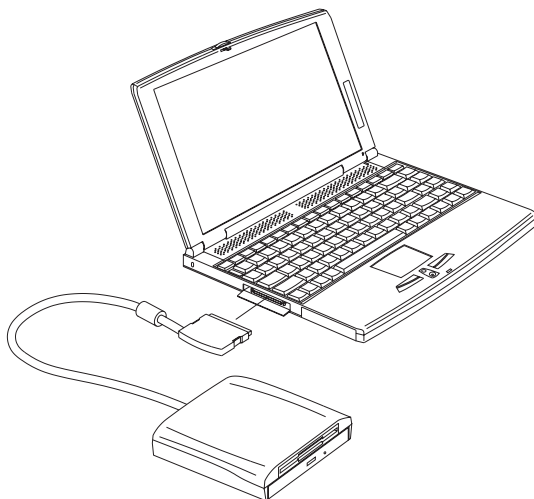

To disconnect the EasyLink Combo Drive:

1. Click on the **HotIDE** icon () on the Windows taskbar.
2. Select the stop operation.
A message appears to confirm the stop operation.
3. Click on **OK**.
4. Disconnect the EasyLink Combo Drive.
5. Tuck in the EasyLink Combo Drive cable connector into its storage slot.



Note: If the computer is on, and you disconnect the EasyLink Combo Drive without using the HotIDE stop function, the computer will hang (stop operating normally). Connect the EasyLink Combo Drive again to solve this problem. It is advisable to follow the connect/disconnect procedures discussed above. If the computer is off, you can disconnect the EasyLink Combo Drive at your convenience.

Ejecting media

Ejecting a floppy disk

Press the floppy disk eject button to eject a floppy disk from the floppy drive.

Ejecting the CD-ROM or DVD-ROM tray

To eject the CD-ROM or DVD-ROM tray when the computer is turned on, press the CD-ROM eject button. When the power is off, you can eject the CD-ROM drive tray using the emergency eject hole. See page 102.

Playing DVD movies

Some models come standard with a DVD-equipped EasyLink DVD Combo Drive. To play DVD movies on your computer, follow these steps:

1. Eject the DVD-ROM tray and insert the DVDEExpress disc; then close the DVD-ROM tray.

The setup program appears. If the setup program does not run automatically, click on **Start, Run....**, then type D:\SETUP.EXE and press **Enter**.

2. Follow the instructions on the screen to complete the installation.



Important! When you launch the DVD player for the first time, the program asks you to input the region code. DVD discs are divided into 6 regions. Once your computer is set to a region code, it will play DVD discs of that region only. You can set the region code a maximum of five times (including the first time), after which the last region code set will remain permanent. Refer to the table later in this section for DVD movie region code information.

3. Remove the DVDEExpress disc from the DVD-ROM tray and insert a DVD movie of the desired region into the DVD-ROM drive.
4. Click on **Start, Programs, Mediamatics DVDEExpress**.
5. Click on **Mediamatics DVD Player**.

Region Code	Country or Region
1	U.S.A., Canada
2	Europe, Middle East, South Africa, Japan
3	Southeast Asia, Taiwan, Korea (South)
4	Latin America, Australia, New Zealand
5	Former U.S.S.R., parts of Africa, India

Region Code	Country or Region
6	People's Republic of China



.....

Note: To change the region code, insert a DVD movie of a different region into the DVD-ROM drive. Please refer to the online help for more information.

▶ Ports

Ports allow you to connect peripheral devices to your computer as you would with a desktop PC. For instructions on how to connect different external devices to the computer, see “3 Peripherals and options” on page 45.

Left port

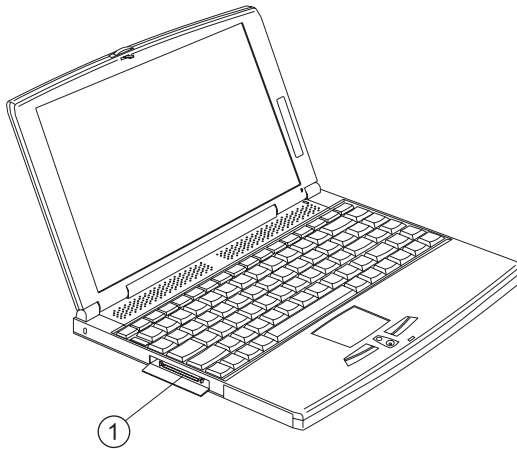

#	Port	Connects to...
1	EasyLink Combo Drive connector	EasyLink Combo Drive. See “EasyLink Combo Drive” on page 16 for details.

Rear ports

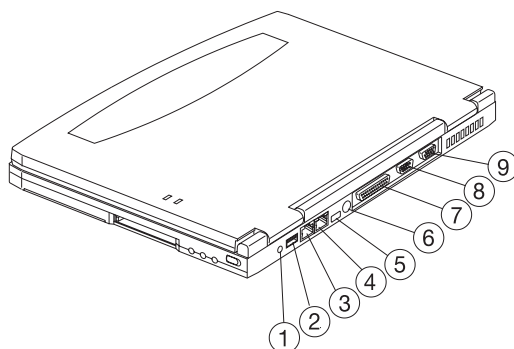

#	Icon	Port	Connects to...
1		Power jack	AC adapter and power outlet
2		USB jack	Universal Serial Bus device (e.g., USB mouse, USB camera)
3		Modem jack	Phone line
4		Network jack	Ethernet 10/100-based network
5		Infrared port	Infrared device (e.g., infrared printer, IR-aware computers)
6		PS/2 port	PS/2-compatible device (e.g., PS/2 keyboard/mouse/keypad)
7		Parallel port	Parallel device (e.g., parallel printer)
8		Serial port	Serial device (e.g., serial mouse)

#	Icon	Port	Connects to...
9		External display port	Display device (e.g., external monitor, LCD projector) up to 1280x1024 resolution at 64K-colors

Universal Serial Bus

The Universal Serial Bus (USB) port is a high-speed serial bus which allows you to connect and daisy-chain USB peripherals without taking up precious system resources.

Fax/data modem

Some models have a built-in V.90 56Kbps PCI fax/data modem.



Warning! This modem port is not compatible with digital phone lines. Plugging this modem into a digital phone line will damage the modem.

To use the fax/data modem port, connect a phone cable from the modem port to a telephone jack.

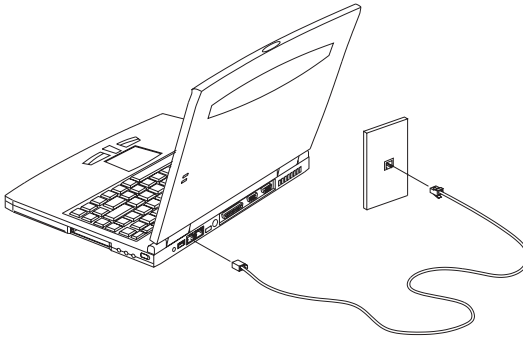

Start your communications software program. See your communications manual for instructions.

Built-in network feature (option)

Available on select models, the built-in network feature allows you to connect your computer to an Ethernet-based (10BaseT and 100BaseT) network.

To use the network feature, connect a Ethernet cable from the network jack on the rear of the computer to a network jack or hub on your network. Then configure network settings for your computer.



Note: Contact your network or system administrator for information on how to configure your computer to work in your network environment.

Fast infrared

The computer's fast infrared (FIR) port allows you to do wireless data transfer with other IR-aware computers and peripherals such as infrared printers. The infrared port can transfer data at speeds of up to four megabits per second (Mbps) at a distance of up to one meter.



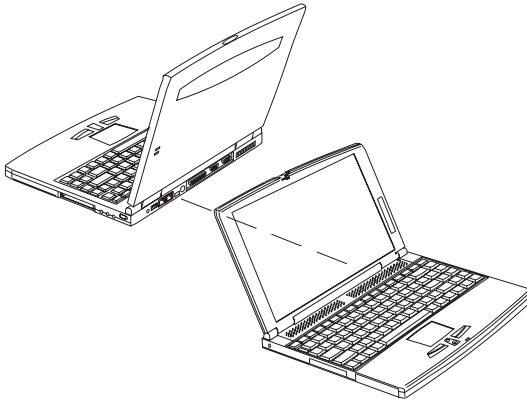

To use FIR, position two IR-aware devices such that their IR ports are no more than one meter apart and offset no more than 15 degrees.

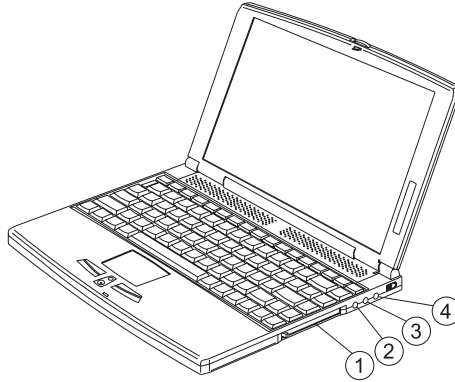

When the two computers are in position, simply begin the data transfer as you normally would. See your file transfer software for details.

Right ports



#	Icon	Port	Connects to...
1		PC Card slot	One 16-bit PC Card or 32-bit CardBus PC Card (Zoomed Video supported)
2		Microphone-in jack	Mono condenser microphone
3		Line-in jack	Audio line-in device (e.g., audio CD player, stereo walkman)
4		Line-out jack	Audio line-out device (e.g., speakers, headphones)

PC Card slot

There is a type II/III CardBus PC Card slot found on the right panel of the computer. This slot accepts a credit-card-sized card that enhances the usability and expandability of the computer.

PC Cards (formerly PCMCIA) are add-on cards for portable computers, giving you expansion possibilities long afforded by desktop PCs. Popular type II cards include flash memory, SRAM, fax/data modem, LAN and SCSI cards. CardBus improves on the 16-bit PC card technology by expanding the bandwidth to 32 bits.

ZV (Zoomed Video) support allows your computer to support hardware MPEG in the form of a ZV PC card.



Note: Refer to your card's manual for details on how to install and use the card and its functions.

Inserting a PC Card



Note: A slot protector card is installed in the PC Card slot. Remove it before you insert your PC Card.

Insert the card into the desired slot and make the proper connections (e.g., network cable), if necessary. See your card manual for details.

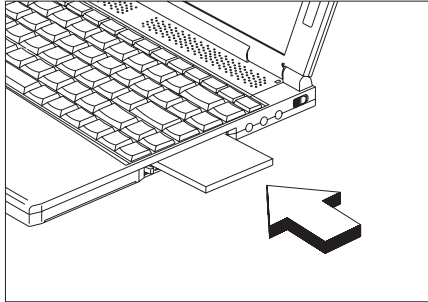

Ejecting a PC Card

Before ejecting a PC Card:

1. Exit the application using the card.
2. Left-click on the PC Card icon on the taskbar and stop the card operation.

3. Press the slot eject button (1) to pop out the eject button (2); then press it again to eject the card (3).

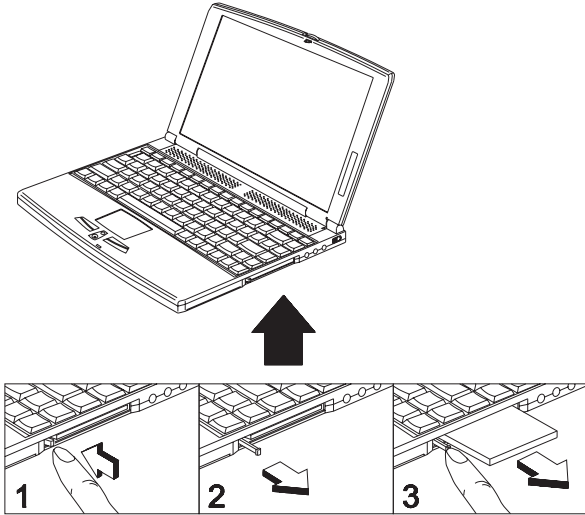

▶ Audio

The computer comes with 16-bit high-fidelity PCI stereo audio.

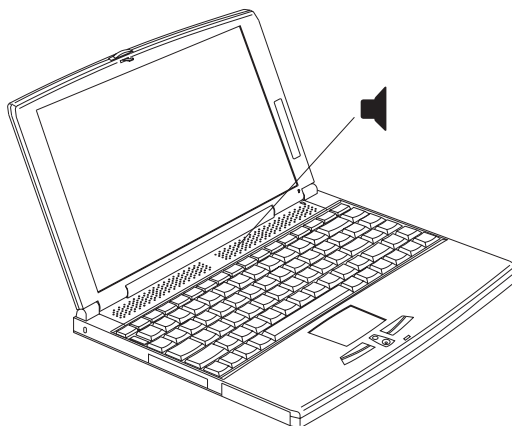

There are audio ports on the right panel of the computer. See “Audio devices” on page 52 for more information on connecting external audio devices.

Adjusting the volume

To adjust the volume, double-click on the volume (speaker) icon on the Windows taskbar, then drag the slider to the desired volume level. You can also hold **Fn** and press the **up/down arrow** keys.

Enabling the 3D effect feature

When connecting to external speakers, you can enable the 3D effect feature for a more immersive experience. Follow these steps:

1. Double-click on the volume (speaker) icon on the Windows taskbar.
If the speaker icon is not displayed on the taskbar, enable this feature (show volume control on the taskbar) via the **Multimedia** icon in the **Control Panel**.
2. Click on the **Options** menu and select **Advanced Controls**.
3. Click on the **Advanced** button that now appears in the Master Volume Balance column.

4. Click **3D Effect** to enable the 3D effect feature.
5. Click on **OK**.

► Securing your computer

Security features include hardware and software locks — a security notch and passwords.

Security keylock notch

A security keylock notch located on the left panel of the computer lets you connect a Kensington-compatible key-based computer security lock.

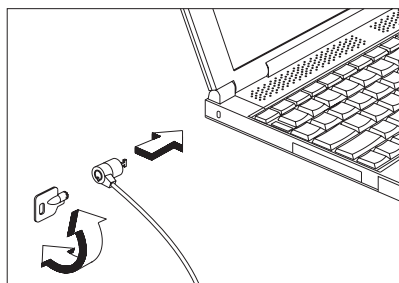

Wrap a computer security lock cable around an immovable object such as a table or locked drawer handle. Insert the lock into the notch and turn the key to secure the lock.

Passwords

Three password types protect your computer from unauthorized access. Setting these passwords creates several different levels of protection for your computer and data:

- Setup Password prevents unauthorized entry to the BIOS Utility. Once set, you must key-in this password to gain access to the BIOS Utility. See “BIOS Utility” on page 88 for details.
- Power-On Password secures your computer against unauthorized use. Combine the use of this password with password checkpoints on boot-up and resume from hibernation for maximum security.
- Hard Disk Password protects your data by preventing unauthorized access to your hard disk. Even if the hard disk is removed from the computer and moved to another computer, it cannot be accessed without the Hard Disk

Password.



Important! Do not forget your Setup and Hard Disk Password! If you forget your password, please get in touch with your dealer or an authorized service center.

Entering passwords

When a password is set, a password prompt appears on the left-hand corner of the display screen.

- When the Setup Password is set, the following prompt appears when you press **F2** to enter the BIOS Utility at boot-up.

Setup Password

Type the Setup Password and press **Enter** to access the BIOS Utility.

- When the Power-on Password is set, the following prompt appears at boot-up.



Type the Power-on Password (a . symbol appears for each character you type) and press **Enter** to use the computer. If you enter the password incorrectly, an **x** symbol appears. Try again and press **Enter**.

- When the Hard Disk Password is set, the following prompt appears at boot-up.



Type the Hard Disk Password (a . symbol appears for each character you type) and press **Enter** to use the computer. If you enter the password incorrectly, an **x** symbol appears. Try again and press **Enter**.



Important! You have three chances to enter a password. If you successfully entered the password, you are presented with a correct entry symbol. If you fail to enter the password correctly after three tries, the following

message or symbol appears.

Setup

Incorrect password specified. System disabled.

Power-on/Hard Disk



Slide and hold the power switch for four seconds to shut down the computer. Then turn on the computer again, and try again. If you fail to enter the Hard Disk Password, please contact your dealer or an authorized service center.

Setting passwords

You can set passwords using:

- Notebook Manager - go to page 83.
- BIOS Utility - go to page 95.



2 Operating on **battery** power

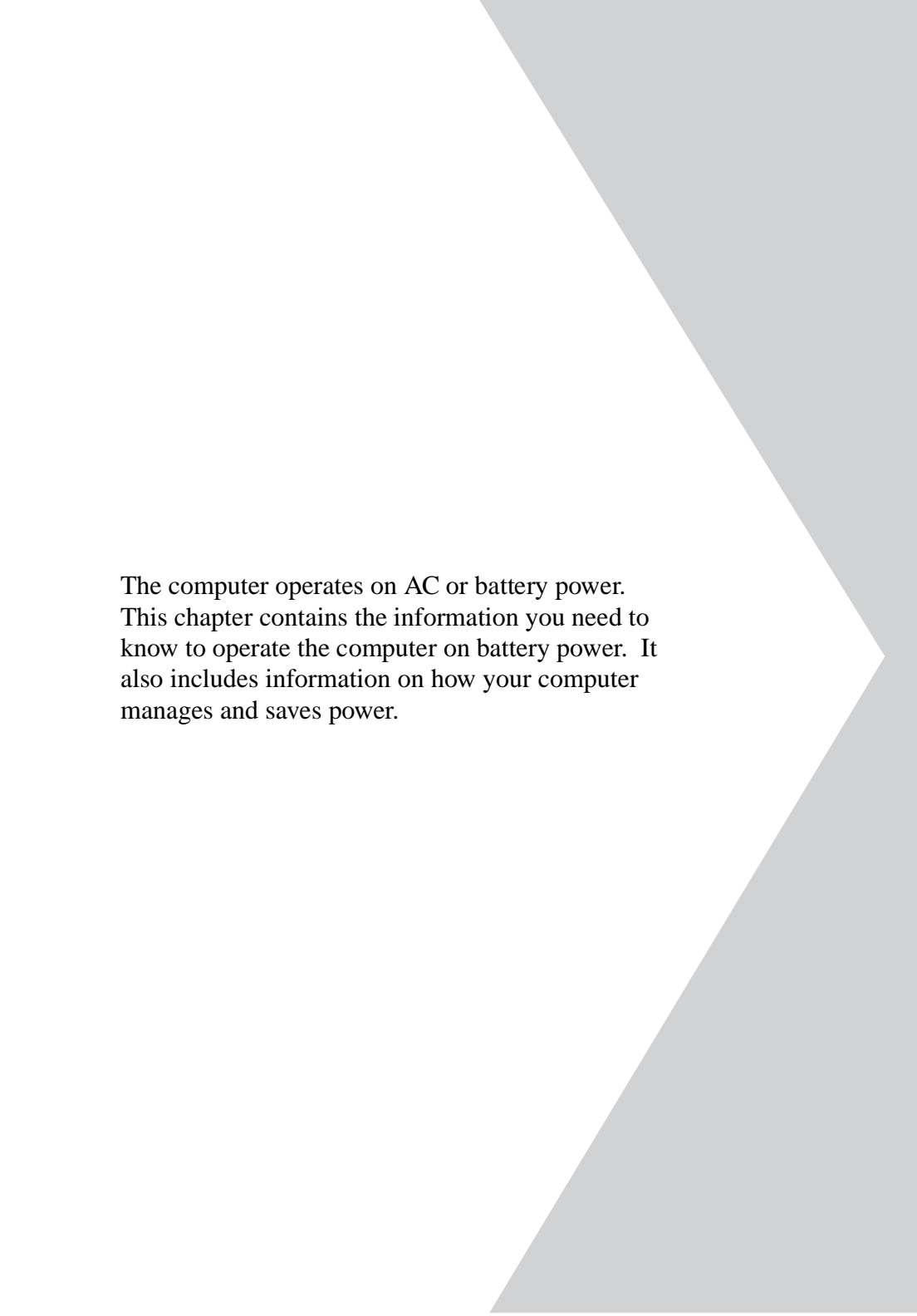

The computer operates on AC or battery power. This chapter contains the information you need to know to operate the computer on battery power. It also includes information on how your computer manages and saves power.

▶ Battery pack

The computer uses a battery pack that gives you long use between charges.

Battery pack characteristics

The battery pack has the following characteristics:

- Employs Current Battery Technology Standards

The computer uses a Lithium-Ion battery pack which does not have the memory effect problem of Nickel Cadmium (NiCd) batteries. Li-Ion batteries consistently provide the longest battery life, best-suited for road warriors.

- Battery-low Warning

When the battery charge level becomes low, the computer gives off warning beeps and the status indicator flashes at regular intervals. This tells the user that the battery power is critically low. You can correct this situation by recharging the battery pack.



.....

Note: Whenever possible, use the AC adapter. The battery will come in handy when you travel or during a power failure. It is advisable to have an extra fully-charged battery pack available as backup.

Using a battery pack for the first time

When using a battery pack for the first time, follow these steps:

1. Disable the Sleep Upon Battery-low parameter in the BIOS Utility. See page 97.
2. Connect the AC adapter to a power source and to the computer and fully recharge the battery.
3. Disconnect the adapter to use up the battery before recharging again.

You only need to do this once with a new battery or with a battery that's been stored without being used for a long time. If the computer is to be stored for more than two weeks, we suggest you remove the battery pack. Battery power from a fully charged battery pack depletes in roughly a day with the computer in Standby mode, or a month in Hibernation mode or when the power is off.



.....

Warning! Do not expose battery packs to temperatures below 0°C (32°F) or above 60°C (140°F). This may adversely affect the battery pack.

Replacing the battery pack



.....

Note: Before removing the battery pack, make sure that you have an AC adapter connected to the computer; otherwise, turn off the computer.

To replace the battery pack, follow these steps:

1. Slide and hold the battery bay release latch and slide the battery out slightly.

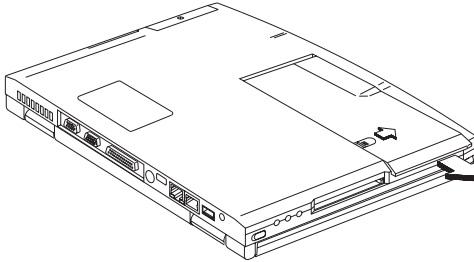

2. Lift up the battery pack to remove it from the battery bay.

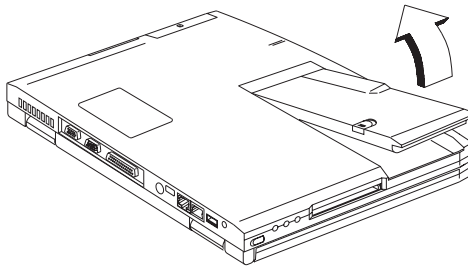

3. Insert a replacement battery pack into the battery bay by following the figures below.

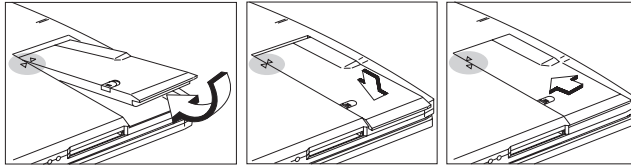

Charging the battery

To charge the battery, place the battery pack inside the battery bay and plug the AC adapter into the computer and an electrical outlet.

Charging modes

The adapter has three charging modes:

Rapid mode

The computer uses rapid charging when power is turned off and a powered AC adapter is connected to it. In rapid mode, a fully depleted battery gets fully charged in two to three hours.

Charge-in-use mode

When the computer is in use with the AC adapter plugged in, the computer also charges the battery pack if installed. This mode will take longer to fully charge a battery than rapid mode. In charge-in-use mode, a fully depleted battery gets fully charged in approximately six to seven hours.

Trickle mode

When the battery is fully charged, the adapter changes to trickle mode to maintain the battery charge level. This prevents the battery from draining while the computer is in use.



Tip! We suggest that you charge the battery pack before retiring for the day, letting it charge overnight before traveling. This ensures a fully charged battery for use the next day.

Checking the battery level

The computer features battery-low warning signals that are both audible and visible. When the battery pack is low, the computer emits warning beeps and the battery indicator flashes at regular intervals. Also, you can check the battery charge level using the Windows battery meter.

Using the Windows battery meter

The Windows battery meter indicates the present battery level. Simply rest your cursor on the battery meter (or AC plug) icon on the taskbar to see the present charge level of your battery.

Optimizing battery life

This section helps you get the most out of battery operation. Optimizing battery life prolongs the charge/recharge cycle and improves recharge efficiency. Follow these suggestions to optimize and maximize battery power:

- Purchase an extra battery pack.
- Use Sleep Manager to reserve hard disk space for the Hibernation function. Keep it running in the background to automatically adjust the Hibernation file size. See “Sleep Manager” on page 74.
- Use the AC adapter whenever possible so that the battery is reserved for on-the-go computing.
- Keep the battery pack in the computer powered by the AC adapter. The constant trickle charge maintains the battery level to eliminate the battery self-discharge effect. The charge-in-use function also charges the battery pack.
- Disable the parallel and serial ports if no devices are connected to these ports. You can do this through the BIOS Utility. See “Onboard Devices Configuration” on page 93.
- Eject the PC card from the card slot when not in use, since the PC card draws extra power.
- Store the battery pack in a cool, dry place. The recommended storage temperature for battery packs ranges from 10 to 30 degrees C. The higher the storage temperature, the faster the battery pack self-discharges.
- The batteries can be recharged about 300 times when used as directed. Excessive recharging decreases battery life.
- Take care of your battery pack and AC adapter. See “Care and maintenance”

on page xvii of the preface.

Battery-low warning

You never have to worry about battery power as long as you are using the AC adapter. However, when you operate the computer on battery power, pay extra attention to the warning beeps and the power indicator on the display panel.

The following signals indicate a battery-low condition:

- The buzzer generates four short beeps every minute, if you enabled the Battery-low Warning Beep parameter in the BIOS Utility.
- The power indicator flashes at regular intervals until battery power is depleted.

When you receive a battery-low warning, you have around two minutes to save your work. If you do not connect the AC adapter within this period, the computer enters Hibernation mode if the Sleep Upon Battery-low parameter in BIOS Utility is enabled and the following conditions exist:

- The Hibernation file created by Sleep Manager is present and valid. See “Sleep Manager” on page 74.
- There is enough battery power left to save system information onto the hard disk.

Otherwise, the computer enters Standby mode.



Warning! Connect the AC adapter to the computer as soon as possible. Data is lost when computer power is cut off during Standby mode.

The following table shows the recommended course of action to take when you encounter a battery-low condition.

Situation	Recommended Action
AC adapter and power outlet available	<ol style="list-style-type: none"> 1. Connect the AC adapter to the computer. 2. Save all necessary files. 3. Resume work. Power off the computer if you wish to recharge the battery rapidly.

Situation	Recommended Action
An extra fully-charged battery pack available	<ol style="list-style-type: none"><li data-bbox="419 236 648 256">1. Save all necessary files.<li data-bbox="419 268 618 288">2. Exit the application.<li data-bbox="419 300 648 320">3. Power off the computer.<li data-bbox="419 331 659 352">4. Replace the battery pack.<li data-bbox="419 363 801 384">5. Power on the computer and resume work.
AC adapter or power outlet not available	<ol style="list-style-type: none"><li data-bbox="419 419 648 440">1. Save all necessary files.<li data-bbox="419 451 618 472">2. Exit the application.<li data-bbox="419 483 648 504">3. Power off the computer.

► Power management

This computer has a built-in power management unit that monitors system activity. System activity refers to any activity involving one or more of the following devices: keyboard, mouse, floppy drive, hard disk, peripherals connected to the serial and parallel ports, and video memory. If no activity is detected for a period of time (called an inactivity time-out), the computer stops some or all of these devices in order to conserve energy.

Your computer supports the following power management standards for reducing power consumption on your computer:

- Advanced Power and Configuration Interface (ACPI) for Windows 98 and future, supported operating systems

ACPI is a more recent power management specification jointly developed by Intel, Microsoft, and Toshiba. ACPI enables Windows 98 to control the amount of power given to each device attached to the computer. With ACPI, Windows 98 can turn off peripheral devices when they are not in use, thereby saving power.

- Advanced Power Management (APM) for Windows 95 and Windows NT 4.0

APM is a power-management approach defined jointly by Microsoft and Intel. A great number of software packages support APM to take advantage of its power-saving features and allow greater system availability without degrading performance.

If your computer is set for APM, you can set timeout values for your computer's devices before power-saving methods are applied to these devices. If your computer is set for ACPI, Windows handles all power-saving chores for your computer.

For general information about the Windows power management system on your computer, refer to the Windows user's manual.



.....

Note: Power management (APM or ACPI) greatly prolongs your battery life.

Power management modes

Sleep mode

Power management functions are handled by the ACPI-aware operating system. In this set-up, you do not need to set timeout values for devices before they enter a power saving mode.

Sleep mode may be one of three computer power saving modes: standby, hibernation or power off. Windows determines which of these modes to enter in.

To enter Sleep mode:

- Press the Sleep hot key **Fn-F4**.
- Idle times for devices and the computer determined by Windows 98 elapses

Exiting sleep mode depends on which power saving mode the computer is currently in.

Standby mode

The computer consumes very low power in Standby mode. Data remains intact in the system memory until the battery is drained.

There are a number of ways to enter Standby mode:

- If the waiting time specified by the System Standby value or the operating system elapses without any system activity
- Closing the display cover
- When the computer is about to enter Hibernation mode (e.g., during a battery-low condition), but the Hibernation file is invalid or not present
- When customized functions for power management are set to Standby and the corresponding action is taken. See “Setting advanced features in power management” on page 86 for more information.
- Invoked by the operating system power-saving modes



Note: If your computer is running Windows NT 4.0 or Windows 95, **Fn-F4** acts as the standby hot key.

The following signals indicate that the computer is in Standby mode:

- The buzzer beeps
- The Sleep indicator lights



Warning! Unstored data is lost when you turn off the computer power in Standby mode or when the battery is drained.

To leave Standby mode and return to normal mode:

- Press any key
- Move the active pointing device (internal or external PS/2)
- Have the resume timer set and let it be matched
- Open the display cover
- Experience an incoming PC card modem event

Hibernation mode

In Hibernation mode, all power shuts off (the computer does not consume any power). The computer saves all system information onto the hard disk before it enters Hibernation mode. Once you turn on the power, the computer restores this information and resumes where you left off upon leaving Hibernation mode.

There is one necessary condition for the computer to enter Hibernation mode:

- The Hibernation file created by Sleep Manager must be present and valid. See “Sleep Manager” on page 74.

In this situation, there are a number of ways to enter Hibernation mode:

- When customized functions for power management are set to Hibernation and the corresponding action is taken. See “Setting advanced features in power management” on page 86 for more information.
- Invoked by the operating system power-saving modes

To exit Hibernation mode, press the power switch. The computer also resumes from Hibernation mode if the resume timer is set and matched.



Warning! Do not change any devices (such as add memory or swap hard disks) when the computer is in Hibernation mode.

Power management for peripherals

Below are examples of how power management is applied to peripherals and devices installed in your computer.

Display standby mode

Screen activity is determined by the keyboard, the built-in touchpad, and an external PS/2 pointing device. If these devices are idle for a specified period, the display shuts off until you press a key or move the touchpad or external mouse.

The computer has a unique "automatic dim" power-saving feature. When the computer is using AC power and you disconnect the AC adapter from the computer, it automatically dims the LCD backlight to save power. If you reconnect AC power to the computer, it automatically adjusts the LCD backlight to a brighter level.

Hard disk standby mode

The hard disk enters standby mode when there are no disk read/write operations within a specified period of time. In this state, the power supplied to the hard disk is reduced to a minimum. The hard disk returns to normal once the computer accesses it.

Setting power management schemes

Power management schemes allow you to specify the degree of power management to use on your computer at any particular time, simply by pressing the power management scheme toggle hot key **Fn-F3**.



Note: When an external keyboard is attached to the computer, this feature is disabled. The feature is also disabled if the operating system does not support it.



3 Peripherals and options

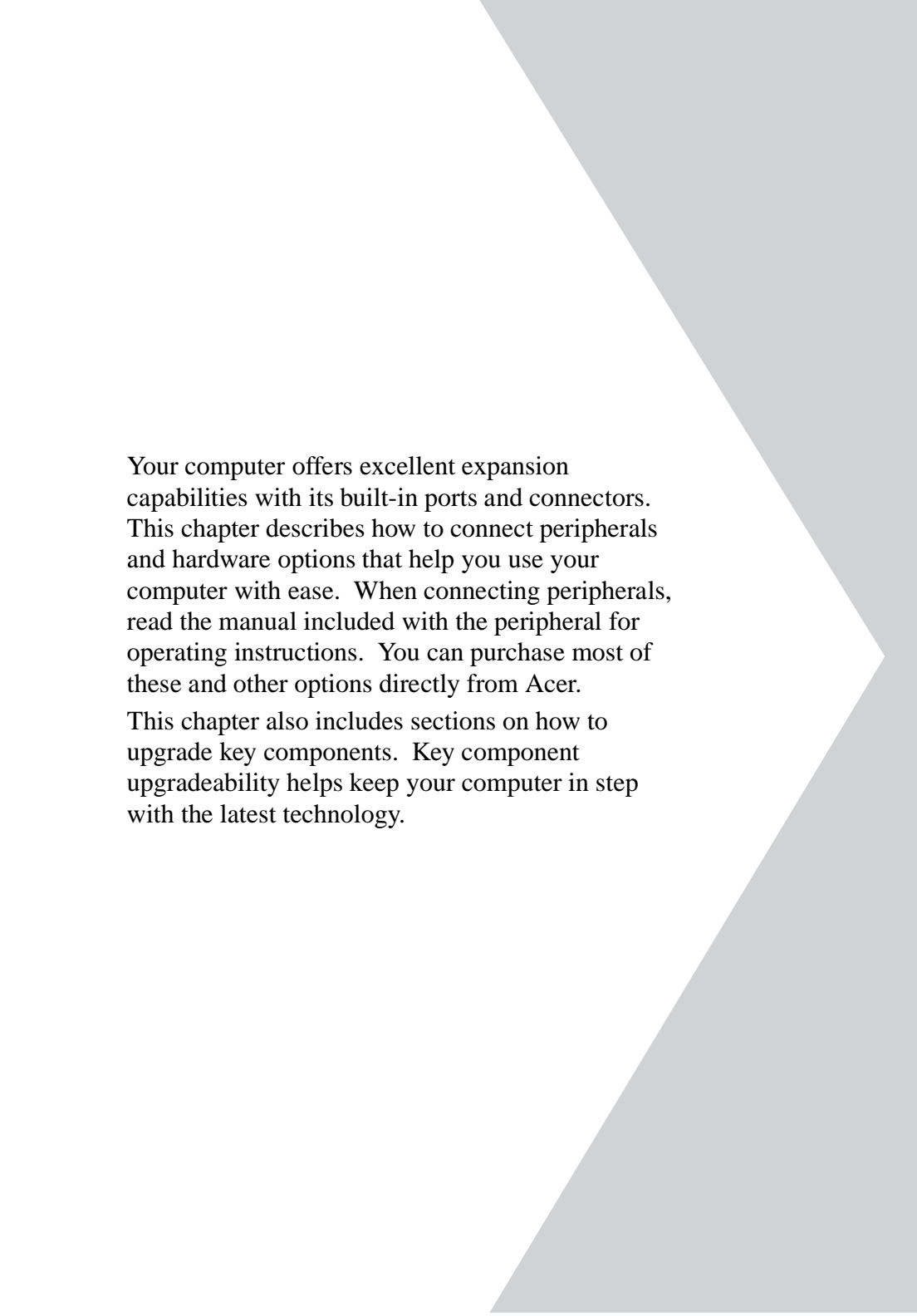

Your computer offers excellent expansion capabilities with its built-in ports and connectors. This chapter describes how to connect peripherals and hardware options that help you use your computer with ease. When connecting peripherals, read the manual included with the peripheral for operating instructions. You can purchase most of these and other options directly from Acer.

This chapter also includes sections on how to upgrade key components. Key component upgradeability helps keep your computer in step with the latest technology.

▶ External monitor

To show graphical effects on a larger display, connect an external monitor to the external display port. Read the monitor manual for additional instructions.



Note: If an external monitor is not connected, closing the display cover puts the computer into standby mode.

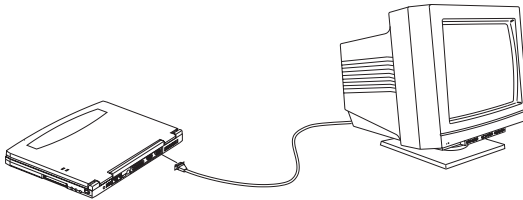

Setting up dualview

Dualview allows you to expand your desktop to an external display device, giving you more desktop space to work on.

Follow these steps to use dualview:

1. Connect an external display device to the external display port of the computer.
2. Enable and set dualview options:
 - a. Click on **Start, Settings, Control Panel**.
 - b. Double-click on **Display**.
 - c. Click on the **Settings** tab.
 - d. Click on **2** (the second monitor icon).
 - e. Click on **Yes**.
 - f. Set the colors and screen area parameters for the second display device.
 - g. Click on **Advanced...** and click on the **Monitor** tab.
 - h. Click on **Change...** and follow the instructions on the screen.
 - i. Click on **OK**.

Printer

This computer supports both serial and parallel printers. For a serial printer, plug the printer cable into a serial port. For a parallel printer, plug the printer cable into the parallel port. See your printer manual for operating instructions.



Note: If the printer does not function, enter the BIOS Utility and verify that the parallel port is enabled. See “Onboard Devices Configuration” on page 93 for assistance.

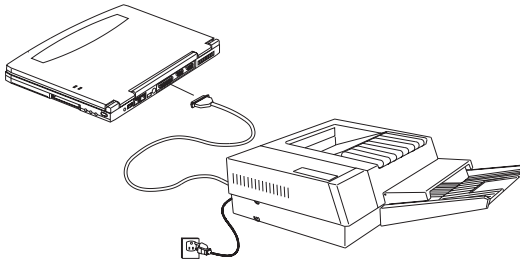

▶ External pointing device

This computer accepts a PS/2-compatible, serial or USB mouse or similar pointing device.



Note: When using an external mouse, you may choose to disable the internal touchpad by pressing **Fn-F7**.

External PS/2 mouse

The built-in touchpad works alternately with an external PS/2 mouse which is hot-pluggable. To use a PS/2-compatible mouse, simply plug it into the PS/2 port.

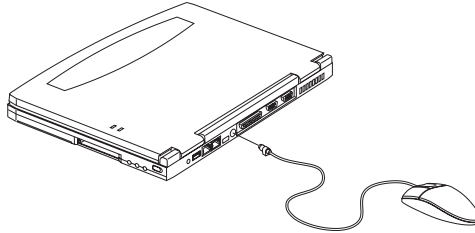

External serial mouse

If you use a serial mouse, plug it into the serial port. Then use the **Add New Hardware** tool in the Windows Control Panel to enable the serial mouse.

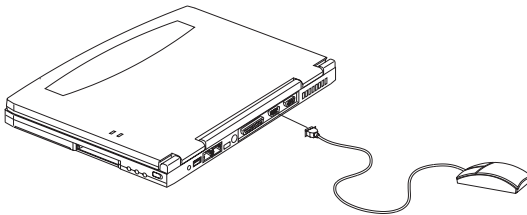

External USB mouse

Plug the USB mouse into the USB port. See “USB devices” on page 54 for more information.

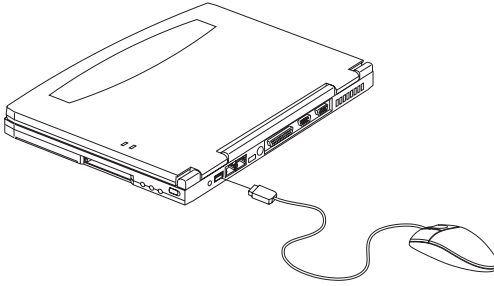

► External keyboard and keypad

This computer has a keyboard with full-sized keys and an embedded keypad. If you feel more comfortable using a desktop keyboard, you can install a PS/2-compatible external keyboard.

To connect an external keyboard, plug the external keyboard into the PS/2 connector.

You can also use a 17-key numeric keypad for number-sensitive data-entry applications. To connect the keypad, plug the keypad connector into the PS/2 port.

▶ Audio devices

Audio devices are easy to connect with the audio ports accessible from the right side of the computer. You can plug in an external microphone to the microphone-in jack, an audio line-in device to the line-in jack, and amplified speakers or headphones to the line-out jack.

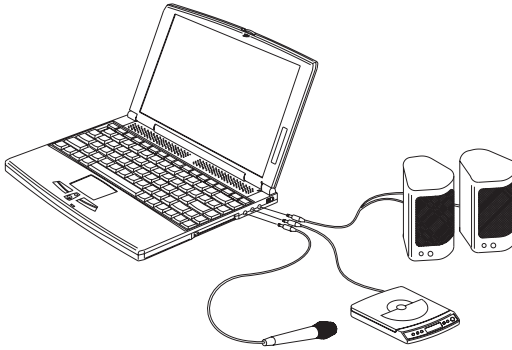

▶ PC Cards

The computer has one CardBus PC card slot that accommodates one type I/II PC card. Please consult your dealer for PC card options available that you can purchase for your computer.



Note: For more information on how to use a PC Card with the computer, see “PC Card slot” on page 24.

▶ USB devices

The computer has a USB (Universal Serial Bus) port that allows you to connect peripherals without occupying too many resources. Common USB devices include the mouse and keyboard.

Most USB devices also include a built-in USB port connector which allows you to daisy-chain other USB devices.



.....

Note: The USB feature must be enabled in BIOS Setup for your USB device to work. See “Startup Configuration” on page 92.

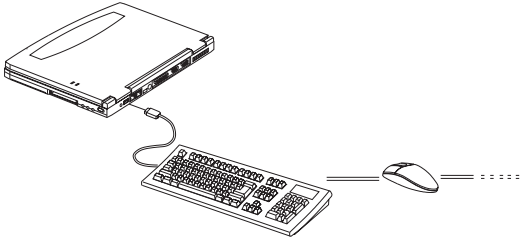

USB video capture kit - option

The USB video capture kit is a fun and easy way to capture still pictures or continuous video even when you're on the road. You can use it to send photos or videos to family and friends or make a video call using your computer. The camera is compact, lightweight, and easy-to-use.



See the USB video capture kit user's guide for more information.

▶ Mobile jacket

The Mobile jacket cover accessory adds a color accent to your computer, giving it a fresh new look.

Follow these steps to install the cover accessory:

1. Flip out and remove the rubber covers on both sides of the display cover.

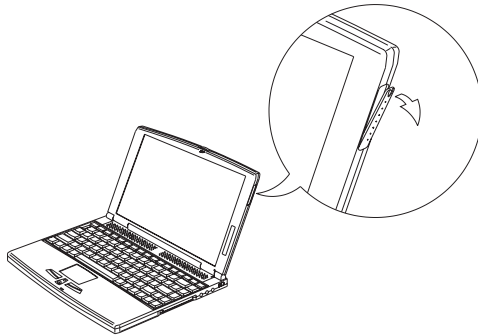

2. Flush the edge of the cover accessory to the edge of the display cover and snap in place..

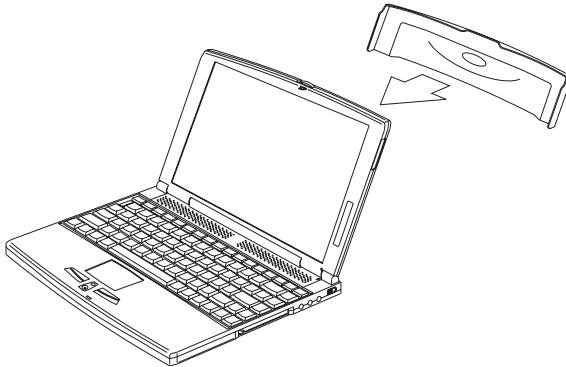

Note: The cover accessory should be removed when you want to attach the USB video capture kit to the computer.

► Miscellaneous options

Battery pack

It is good practice to have a spare battery around, especially when you travel. The Lithium-Ion battery, coupled with power management features, supplies you with more power on-the-go.

AC adapter

The compact AC adapter charges your battery pack and supplies power to your computer. You can order a spare AC adapter so you do not need to carry it from the office to your home or destination.

External battery charger

The external battery charger charges your battery pack when it is not installed in your computer - practical for charging spare battery packs.

PS/2 y-bridge cable

The PS/2 Y-bridge cable allows you to connect two PS/2 devices, a mouse and a keyboard, to your computer simultaneously.

Connect the single connector end of the y-bridge cable to the computer's PS/2 port and the double connector ends to the two PS/2 devices (taking note the icons marked on the connector ends).

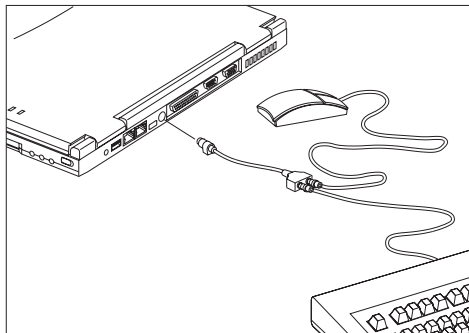

File transfer cable

Besides using the infrared port, you can also transfer files between computers using a file transfer cable. Connect the file transfer cable between the parallel ports of the two computers and use your file transfer utility to perform the transfer.

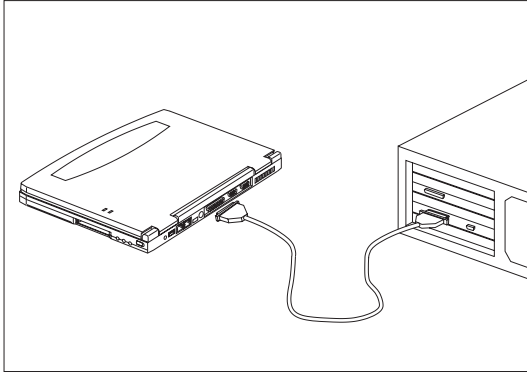

▶ Key component upgrades

Your computer delivers superior power and performance. However, some users and the applications they use may demand more. This computer allows you to upgrade key components when you need increased performance.



Note: Contact your authorized dealer if you decide to perform a key component upgrade.

Memory upgrade

Memory is expandable to 256 MB, employing 32-/64-/128-MB 64-bit industry standard soDIMMs (Small Outline Dual Inline Memory Modules). The computer supports SDRAM (Synchronous Dynamic Random Access Memory).

There are two memory slots on your computer, one of which is user-upgradeable.



Note: If you need to upgrade the main memory slot, please contact your dealer.

Installing memory

Follow these steps to install memory:

1. Turn off the computer, unplug the AC adapter (if connected) and remove the battery pack. Then turn the computer over to access its base.
2. Remove the screws from the memory door; then lift up and remove the memory door.

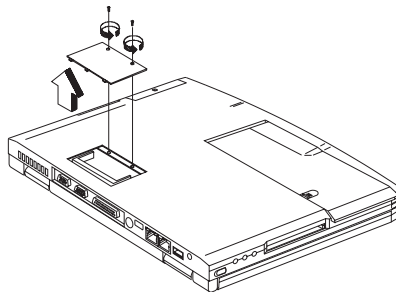

3. Insert the memory module diagonally into the slot, then gently press it down until it clicks into place.

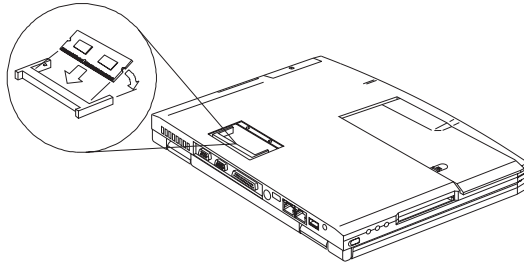

4. Replace the memory door and secure it with the screw.

The computer automatically detects and reconfigures the total memory size.

Hard disk upgrade

You can upgrade your hard disk with a higher capacity drive when you need more storage space. The computer uses a 9.5mm, 2.5-inch Enhanced-IDE hard disk.

Installing a replacement hard disk

Follow these steps to install a hard disk:

1. Turn off the computer, unplug the AC adapter (if connected) and remove the battery pack. Turn the computer over to access its base.
2. Locate the hard disk bay. Remove the hard disk bay screw.

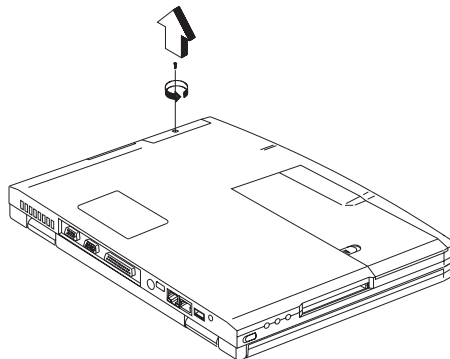

3. Pull out the hard disk.

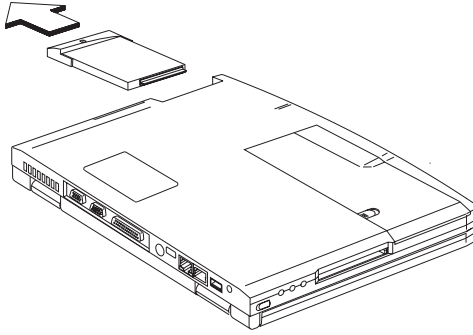

4. Insert a new hard disk module into the hard disk bay and tighten the hard disk bay screw.



4 Moving with your computer

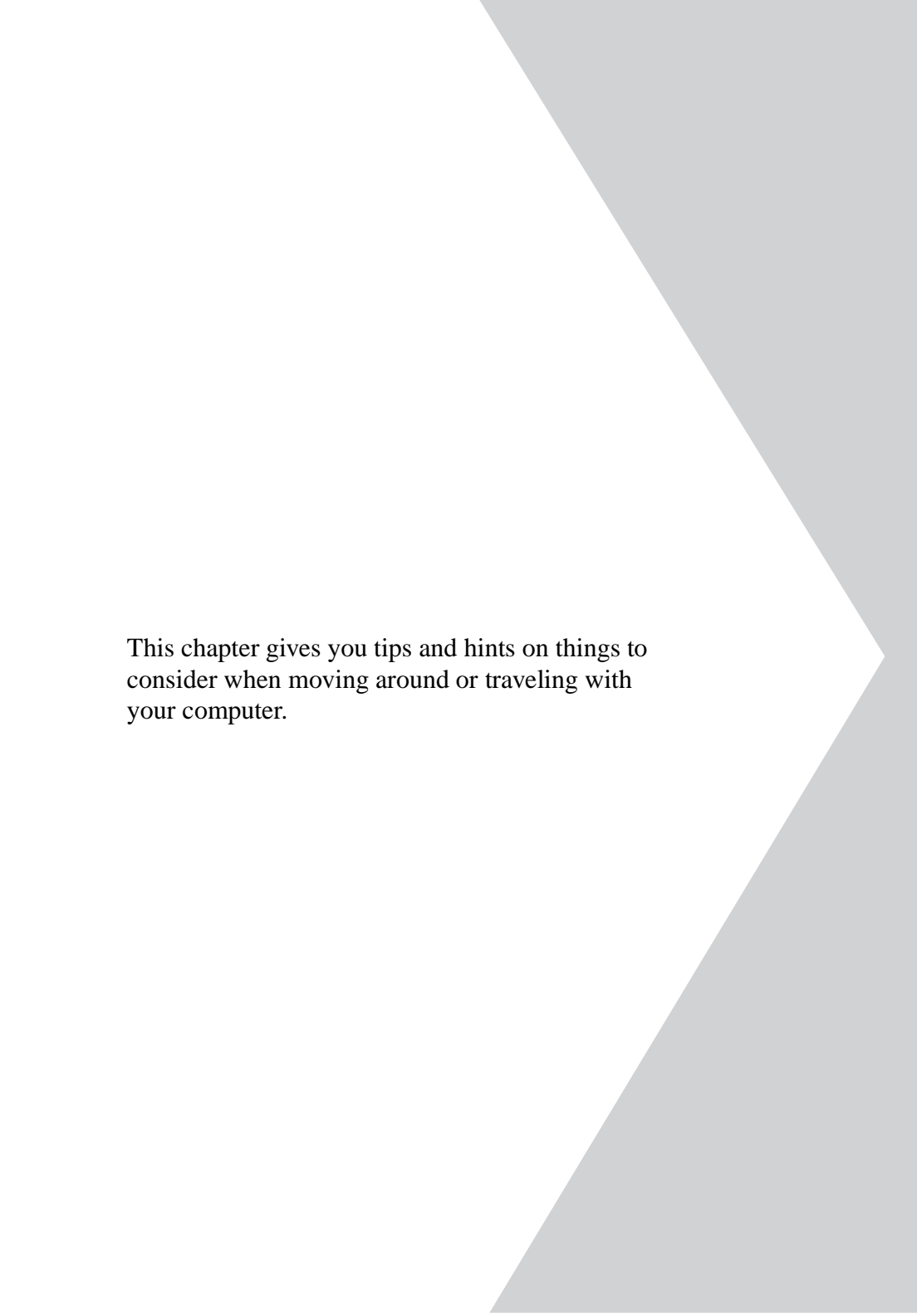

This chapter gives you tips and hints on things to consider when moving around or traveling with your computer.

▶ Disconnecting from the desktop

Follow these steps to disconnect your computer from external accessories:

1. Save your work in progress.
2. Remove any media, diskette and compact disc, from the EasyLink Combo Drive.
3. Shut down the operating system.
4. Turn off the computer.
5. Disconnect the EasyLink Combo Drive from the computer, if necessary.
6. Disconnect the cord from the AC adapter.
7. Disconnect the keyboard, pointing device, printer, external monitor, and other external devices.
8. Disconnect the Kensington lock if you are using one to secure the computer.

► Moving around

“when you are just moving within short distances, for example, from your office desk to a meeting room”

Preparing the computer

Before moving the computer, close and latch the display cover to place it in Sleep mode. You can now safely take the computer anywhere you go within the building. To bring the computer out of Sleep mode, open the display.

If you are taking the computer to a client's office or a different building, you may choose to shutdown the computer:

1. Click on **Start, Shut Down...**
2. Select Shut down and click on **OK**.

- or -

you can put the computer in Sleep mode by pressing **Fn-F4**. Then close and latch the display.

When you are ready to use the computer again, unlatch and open the display, and press any key. If the power indicator is off, the computer has entered Hibernation mode and turned off. Slide and release the power switch to turn the computer back on. Note that the computer may enter Hibernation mode after a period of time it is in Sleep mode. Turn the power on to wake up the computer from Hibernation mode.

What to bring to short meetings

A fully charged battery runs the computer for about three and a half hours under most circumstances. If your meeting is shorter than that, you probably do not need to bring anything with you other than the computer.

What to bring to long meetings

If your meeting will last longer three and a half hours or if your battery is not fully charged, you may want to bring the AC adapter with you to plug in your computer in the meeting room.

If the meeting room does not have an electrical outlet, reduce the drain on the battery by putting the computer in Sleep mode. Press **Fn-F4** or close the display

cover whenever you are not actively using the computer. Then tap any key or open the display to resume.

▶ Taking the computer home

“when you are moving from your office to your home or vice versa”

Preparing the computer

After disconnecting the computer from your desktop, follow these steps to prepare the computer for the trip home:

- Check if you have removed all media, diskette and compact disc, from the EasyLink Combo Drive. Failure to remove the media can damage the drive head.
- Pack the computer in a protective case that can prevent the computer from sliding around and cushion it if it should fall.



Caution: Avoid packing items next to the top cover of the computer. Pressure against the top cover can damage the screen

What to bring with you

Unless you already have some items at home, bring the following items with you:

- AC adapter and power cord
- The printed user's manual
- EasyLink Combo Drive

Special considerations

Follow these guidelines to protect your computer while traveling to and from work:

- Minimize the effect of temperature changes by keeping the computer with you.
- If you need to stop for an extended period of time and cannot bring the computer with you, leave the computer in the trunk of the car to avoid exposing the computer to excessive heat.
- Changes in temperature and humidity can cause condensation. Allow the computer to return to room temperature, and inspect the screen for condensation before turning on the computer. If the temperature change is greater than 18°F (10°C), allow the computer to come to room temperature slowly. If possible, leave the computer for 30 minutes in an environment with

a temperature between outside and room temperature.

Setting up a home office

If you frequently work on your computer at home, it may be worthwhile purchasing a second AC adapter for use at home. With a second AC adapter, you can avoid transporting the extra weight to and from home.

If you use your computer at home for significant periods of time, you might also want to add an external keyboard, monitor, or mouse.

▶ Traveling with the computer

“when you are moving within a larger distance, for instance, from your office building to a client’s office building or traveling locally”

Preparing the computer

Prepare the computer as if you were taking it home. Be sure the battery in the computer is charged. Airport security may require you to turn on your computer when bringing it into the gate area.

What to bring with you

Bring the following items with you:

- AC adapter
- Spare, fully-charged battery pack(s)
- EasyLink Combo Drive
- Additional printer driver files if you plan to use another printer

Special considerations

In addition to the guidelines for taking the computer home, follow these guidelines to protect your computer while traveling:

- Always take the computer as carry-on luggage.
- If possible, have the computer inspected by hand. Airport security X-ray machines are safe, but do not put the computer through a metal detector.
- Avoid exposing floppy disks to hand-held metal detectors.

▶ Traveling internationally with the computer

“when you are moving from country to country”

Preparing the computer

Prepare the computer as you would normally prepare it for traveling.

What to bring with you

Bring the following items with you:

- AC adapter
- Power cords that are appropriate to the country to which you are traveling
- EasyLink Combo Drive
- Spare, fully-charged battery packs
- Additional printer driver files if you plan to use another printer
- Proof of purchase, in case you need to show it to customs officials
- International Traveler’s Warranty passport

Special considerations

Follow the same special considerations as when traveling with the computer. In addition, these tips are useful when traveling internationally:

- When traveling in another country, check that the local AC voltage and the AC adapter power cord specifications are compatible. If not, purchase a power cord that is compatible with the local AC voltage. Do not use converter kits sold for appliances to power the computer.
- If you are using the modem, check if the modem and connector is compatible with the telecommunications system of the country you are traveling in.



.....

Note: If you are using Windows 95, you need to set the country location using the Modem Country Selection program in the Control Panel.

5 Software

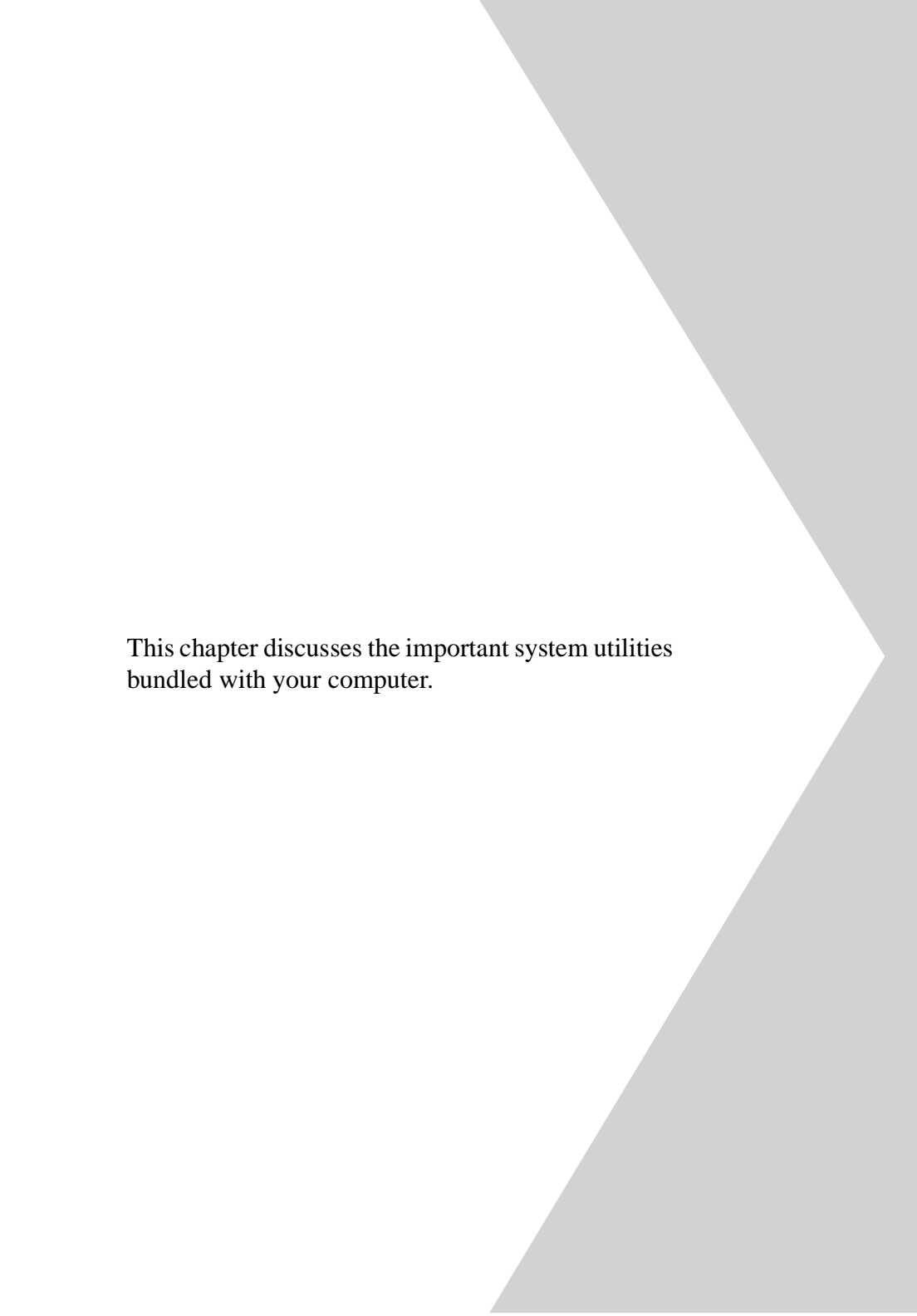

This chapter discusses the important system utilities
bundled with your computer.

The computer comes preloaded with the following software:

- Windows 98 or Windows NT operating system
- BIOS Utility
- System utilities, drivers and application software



Note: To access Windows software applications, click on the **Start** button and select the application folder. Then click on the application icon to run the selected application. To learn about the software and utility, make use of the online help provided by the software.

Your computer is also compliant with or supports the following:

- LDCM (LANDesk® Client Manager)
- DMI (Desktop Management Interface) 2.0
- ACPI (Advanced Configuration and Power Interface) or APM (Advanced Power Management)

▶ Sleep Manager

Most notebook computers feature built-in power-saving functions. This computer has two power management modes, Standby and Hibernation.

While Standby puts your computer into a light sleep state, Hibernation shuts off all power after saving the current state of your computer. The next time you slide the power switch, the computer resumes from where you left off.

Sleep Manager allows your computer to perform these functions.



Note: See “Power management” on page 41 to understand how your computer saves and manages power.

Sleep Manager is a utility that works with your computer’s BIOS and Windows ACPI (Advanced Configuration and Power Interface) or APM (Advanced Power Management) to manage the Hibernation operation. This includes:

- creating the Hibernation file which contains the current state of the computer
- checking if the Hibernation file is valid
- saving and loading the contents of the Hibernation file when entering to and resuming from Hibernation mode

The Hibernation file resides in a contiguous area on your hard disk.

Sleep Manager can automatically create, recover, and reallocate space for the Hibernation file. If the system memory size was changed or the Hibernation file on the hard disk was corrupted, Sleep Manager reallocates the hard disk space for you automatically.

Accessing the Sleep Manager

There are two ways to bring up the Sleep Manager.

- On the Taskbar

The computer automatically loads Sleep Manager every time you start Windows. Sleep Manager resides in the background and appears as an icon on the taskbar.

Double-click on the Sleep Manager status icon if enabled to bring up the main Sleep Manager program. The icon also shows the current status of the Hibernation feature, and changes to tell you if the feature is valid or not. Resting your cursor on the icon also shows the status.

The Sleep Manager icon may or may not appear on the taskbar. A checkbox in the Sleep Manager main screen determines whether to enable or disable the icon on the taskbar.

- Start menu
 - a. Click on **Start, Programs, Sleep Manager**.
 - b. Select the **Sleep Manager** program.

The Sleep Manager displays below:



Item	Description
Buttons	Click to access the Sleep Manager functions.
Current Setting	Displays the drive and size of the current reserved space created by Sleep Manager.

Item	Description
On Board Information	<p>Displays the different areas of system memory and their respective sizes. These system resources need to be stored before the computer can enter Hibernation mode, so that the computer can resume successfully.</p> <p>These resources are the contents of: Onboard memory (DRAM or dynamic memory), Video RAM (VRAM or video memory), SMRAM (static memory), and Others.</p> <p>The total size of these resources shows as the recommended size in the dialog box.</p>
Recommended Size	<p>Displays the minimum size of the contiguous space you need for the Hibernation feature. The actual size may be a little bit more due to file system alignment.</p>
Enable Indicator on the Taskbar	<p>When this checkbox is checked, the Sleep Manager status appears on the taskbar. Double-click on the Sleep Manager status icon on the taskbar to bring up the main program, or simply rest your cursor on the icon to display the current status.</p>

Sleep Manager functions

Create

Sleep Manager automatically finds a contiguous area on your hard disk and creates the Hibernation file in this space. You can also perform this function by clicking on the **Create** button. When you click on the **Create** button, a dialog box pops up:

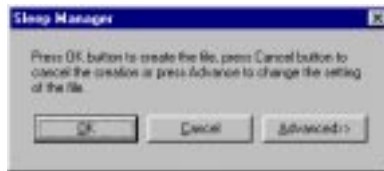

Select **OK** to automatically create the Hibernation file. Sleep Manager displays the recommend size based on onboard system information. You can also choose

Advanced>> to manually set the space settings and size. The advanced screen shows below.

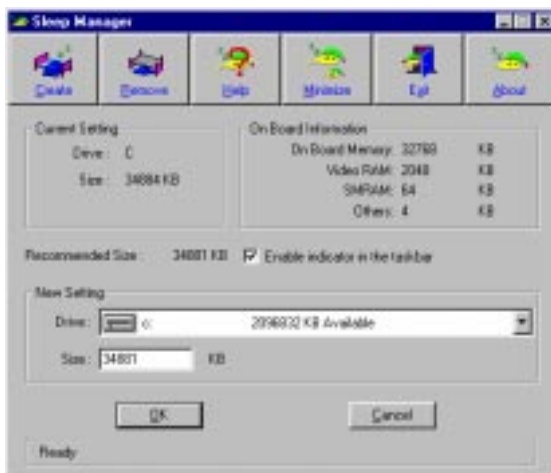

Sleep Manager automatically checks the system configuration and displays the recommended size. The drive where the space will be created is defined by the system and will be the first available logical drive which has the requested contiguous free disk space on it. The recommended size is the minimum size needed to save the current system status.

If the program cannot find the required space on the hard disk during the space creation process, it shows a message box to inform the user.

Remove

If you want to use or take back the reserved space, click on the Remove button. This will disable the Hibernation feature. Instead, the computer will only be able to enter Standby mode.

Minimize

Minimize Sleep Manager by selecting the **Minimize** button. If the Enable indicator on taskbar box is checked, Sleep Manager will switch to the background by locating itself on the taskbar. You can pop-up Sleep Manager again by double-clicking on this icon.

Exit

Exit Sleep Manager by selecting the Exit button. Sleep Manager will quit and disable the capability of auto-adjusting the reserved space size. Exiting Sleep Manager is NOT recommended.



Caution: Do not deactivate (remove or exit) or uninstall Sleep Manager. Do not remove or delete the Hibernation file. Hibernation will not work without Sleep Manager and the Hibernation file.

▶ Notebook Manager

The computer has a built-in system setup program called Notebook Manager. The Windows-based Notebook Manager allows you to set passwords, the startup sequence of the drives and power management settings. It also shows current hardware configurations.



Note: Certain hot key functions are disabled when you access the Notebook Manager, because these functions are also found in the Notebook Manager.

To start the Notebook Manager, press **Fn-F2** or follow these steps:

1. Click on **Start, Programs, Notebook Manager**.
2. Select the **Notebook Manager** application to run the program.



Note: Changes made to most settings in the Notebook Manager take effect the next time the computer restarts. Changes made in the Power Management and Display Device screens take effect immediately.

Notebook Manager consists of six sections:

- Information Viewer
- POST
- Boot Sequence
- Password
- Power Management
- Display Device

To select a section, click on the tab of the section you want to view.

Information Viewer

Information Viewer summarizes and lists information about the specifications and settings of the different components of your computer.



Note: The figure above is for your reference only and the items shown in the figure and the table below may differ from the ones shown on your computer.

Item	Description
CPU	Brand, type and clock speed of the CPU (Central Processing Unit)
Total Memory	Total amount of main memory (in megabytes)
Video RAM	Total amount of video memory (in megabytes)
Hard Disk	Size of hard disk (in megabytes)
CD-ROM or DVD-ROM detected	EasyLink Combo Drive type
Serial Port 1	Resource settings of serial port 1
Parallel Port	Resource settings of the parallel port

Item	Description
Internal Cache	Total amount of internal cache memory (in kilobytes)
External Cache	Total amount of external cache memory (in kilobytes)
Touchpad	Setting of the internal pointing device
Pointing Device	Type(s) of the pointing device(s) detected, internal and external
Change Asset Tag Number button	Changes the Asset Tag Number of your computer

The current version of the computer's BIOS shows before the Device-Configuration table.

POST

POST (Power On Self-Test) defines how your computer behaves when starting up.



There are items in this screen include:

Item	Description
Enable Fast Boot	The Fast Boot feature allows your computer to boot up and resume from Hibernation mode faster. The operating system and the BIOS communicates information about Plug-and-Play resources and previous boot-ups.
Enable hotkey beep	Select to allow the computer to give off beeps when a hotkey is pressed

Boot Sequence

Boot Sequence defines the boot sequence to follow when your computer boots up.



The Boot Sequence screen displays the bootable devices in your computer and the order in which the booting sequence will occur. The devices include the following:

- Floppy Drive
- IDE Hard Drive
- CD-ROM/DVD-ROM Drive

Simply drag and drop the devices to change the booting order. Click on **Apply** to accept.

Password

Password is used to set, modify or delete the password(s) for your computer.



There are two passwords you can set using the Notebook Manager:

- Setup Password prevents unauthorized access to the Notebook Manager and BIOS Utility.
- Power-On Password prevents unauthorized access to your computer at system startup and at resume from Standby/Hibernation or Sleep mode.



The Hard Disk Password is set using the BIOS Utility. See “System Security” on page 95 and “Passwords” on page 29 for details.

Setting the Power-On Password

To set the Power-On Password, follow these steps:

1. Click on the **Change Power-On Password** button.

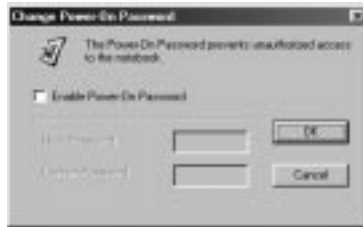

2. Click on the Enable Power-On Password checkbox.
3. Click in the New Password textbox and type in up to seven alphanumeric characters (A-Z, a-z, 0-9) which you want to be your Power-On Password.
4. Click in the Confirm Password textbox and retype the password.
5. Click on **OK**.

Setting the Setup Password

To set the Setup Password, follow these steps:

1. Click on the **Change Setup Password** button. The following dialog box displays:



2. Click on the Enable Setup Password checkbox.
3. Click in the New Password textbox and type in up to seven alphanumeric characters (A-Z, a-z, 0-9) which you want to be your Setup Password.
4. Click in the Confirm Password textbox and retype the password.
5. Click on **OK**.



.....

Note: To change a password, follow the same steps used to set a password. To remove a password, follow the same steps used to set a password but leave both fields blank.

Power Management

Power Management is used to set advanced settings related to power management.



Setting advanced features in power management

To set advanced features, do the following:

1. Click on the **Advanced** button.



2. Set the advanced features in the **Advanced** tab.

The settings in this screen determine how the computer behaves when you (a) close the display, (b) press the power switch, and (c) press the Sleep button **Fn-F4**. Options include the following:

- Standby - the computer enters Standby mode
- Hibernate - the computer enters Hibernation mode
- Shutdown - the computer closes all programs and shuts down

3. Click on **OK**.

Display Device

Display Device is used to control various settings related to display device(s), such as the display brightness level.



The items in this screen include:

Item	Description
Boot Display Device	Sets the default display device on boot-up.
Switching Display Device	Sets the current display device. Make sure an external monitor is connected before External monitor is selected.
Brightness for LCD Panel	Click and drag to set the LCD screen brightness levels.

Click on the radio button of the desired item, then click on **Apply**. To modify the brightness level, click and hold the slider control and move to the right to increase, or move to the left to decrease the setting. You can also click on the item, and use the cursor keys to set the desired level.

► BIOS Utility

The BIOS Utility is a hardware configuration program built into your computer's BIOS (Basic Input/Output System).

Your computer is already properly configured and optimized, and you do not need to run this utility. However, if you encounter configuration problems, you may need to run this program. Please also refer to “6 Troubleshooting” on page 99 when a problem arises.

Using the BIOS Utility

To start the BIOS Utility, follow these steps:

1. Save your work and restart the computer.
A BIOS Utility entry reminder appears near the bottom of the screen.
2. Press **F2** to enter the BIOS Utility. The BIOS Utility main screen appears.

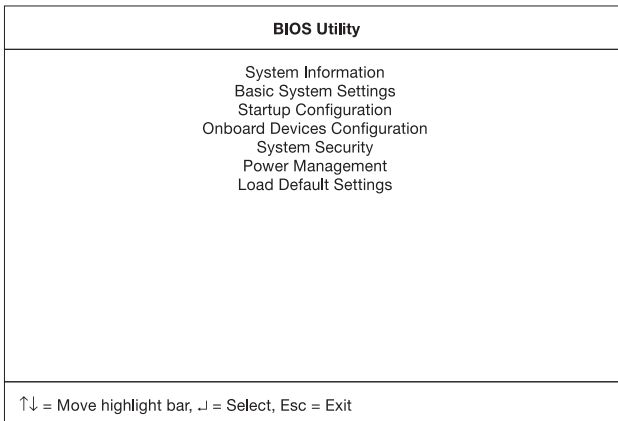

There are seven menu options. Use the cursor up/down keys to select a menu item, then press **Enter**. After you enter a sub-menu, you can:

- use the **cursor up/down** keys to move between the parameters
- use the **cursor left/right** keys to change the value of a parameter
You can change the value of a parameter if it is enclosed in square brackets.
- press **Esc** to exit the current sub-menu

At the main menu, press **Esc** to exit the BIOS Utility. If you make any changes, the following dialog box displays:

Settings have been changed. Do you want to save CMOS settings?	
[Yes]	[No]

If you would like to keep the changes you made, use the **cursor left/right** keys to select **Yes**; then press **Enter**. Choose **No** if you want to discard the changes you made.

System Information

The System Information sub-menu displays basic and important information about your computer.

System Information		Page 1/1
CPU Type & Speed -----	Pentium III 450 Mhz	
Floppy Disk Drive -----	None	
Hard Disk Drive -----	5729 MB	
HDD Serial Number -----	AF0AFAL0692	
System with -----	None	
System BIOS Version -----	V3.0 R01-A00.16	
VGA BIOS Version -----	MTTV15.04	
Serial Number -----	N/A	
Asset Tag Number -----	N/A	
Product Name -----	TravelMate 340 Series	
Manufacturer Name -----	N/A	
UUID -----	00000000000000000000000000000000	
Esc = Exit		



Note: The screen above is a sample and may not reflect the actual data on your computer.

The following table describes the information in this sub-menu.



Note: "x" may refer to a series of numbers and/or characters or a combination of both.

Parameter	Description
CPU Type & Speed	Shows the type and speed in Megahertz of the Central Processing Unit (CPU).
Floppy Disk Drive	Shows the floppy disk drive type.
Hard Disk Drive	Shows the size or capacity of the hard disk.
HDD Serial Number	Shows the serial number of the hard disk.
System with	Shows the EasyLink Combo Drive type, CD-ROM or DVD-ROM.
System BIOS Version	Shows the version number of the BIOS.
VGA BIOS Version	Shows the version number of the VGA display BIOS.
Serial Number	Shows the serial number of the computer.
Asset Tag Number	Shows the asset number of the computer.
Product Name	Shows the product name of the computer.
Manufacturer Name	Shows the manufacturer of the computer.
UUID	Shows the universally unique identifier of your computer.

The items in this sub-menu are important and vital information about your computer. If you experience computer problems and need to contact technical support, this data helps our service personnel know more about your computer.

Basic System Settings

The Basic System Settings sub-menu allows you to set the system date and time.

Basic System Settings		Page 1/1
Date -----	[Fri Aug 27, 1999]	
Time -----	[10:06:35]	
↑↓ = Move highlight bar, ←→ = Change setting, F1 = Help		

The following table describes the parameters in this sub-menu.

Parameter	Description	Format
Date	Sets the system date.	DDD MMM DD, YYYY (day-of-the-week month day, year)
Time	Sets the system time.	HH:MM:SS (hour:minute:second)

Startup Configuration

The Startup Configuration sub-menu contains parameter values that define how your computer behaves on system startup.

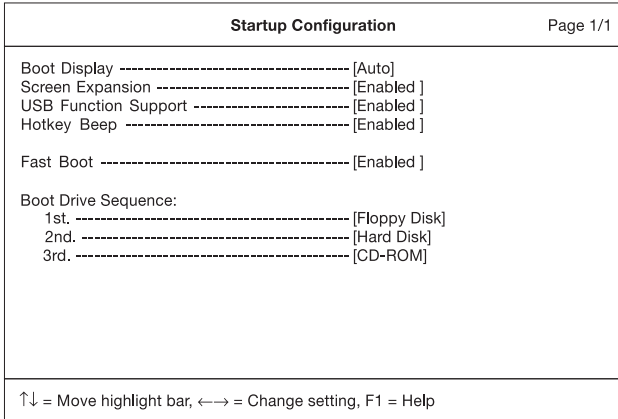

The following table describes the parameters in this sub-menu. Settings in **boldface** are the default and suggested parameter settings.

Parameter	Description	Options
Boot Display	Sets the display on boot-up. When set to Auto , the computer automatically determines the display device when the computer starts up. If an external display device (e.g., monitor) is connected, it becomes the boot display; otherwise, the computer LCD is the boot display. When set to Both , the computer outputs to both the computer LCD and an external display device if one is connected.	Auto or Both
Screen Expansion	Enables or disables the screen expansion feature. When enabled, DOS screens expand to fill the LCD.	Disabled or Enabled
USB Function Support	Enables or disables the Universal Serial Bus (USB) port.	Disabled or Enabled

Parameter	Description	Options
Hotkey Beep	Enables or disables a system beep when a hotkey or key combination is pressed.	Enabled or Disabled
Fast Boot	Fast Boot allows your computer to boot up and resume from Sleep mode (including Standby and Hibernation modes) faster. When enabled, the operating system and BIOS communicate information about Plug-and-Play resources and previous boot-ups.	Enabled or Disabled
Boot Drive Sequence	Specifies the order in which the computer starts up from. See the section below.	1st: Floppy Disk, 2nd: Hard Disk, 3rd: CD-ROM

Setting the Boot Drive Sequence

The Boot Drive Sequence section lists boot priorities (1st, 2nd and 3rd) for bootable drives in your computer.

For example, the default value (1st:Floppy Disk, 2nd:Hard Disk, and 3rd:CD-ROM) tells the computer to first search for a bootable floppy disk in the floppy drive. If it finds one present, it boots up from that floppy disk. If not, the computer continues by booting up from the hard disk. If it cannot boot up from the hard disk, it continues to search for a bootable CD-ROM in the CD-ROM drive.

To set the boot drive sequence, use the **cursor up/down** keys to select a priority level (1st, 2nd, or 3rd); then use the **cursor left/right** keys to select the device for that priority level.

Onboard Devices Configuration

The parameters in this screen are for advanced users only. You do not need to change the values in this screen because these values are already optimized.

The Onboard Devices Configuration sub-menu assigns resources to basic computer communication hardware.

Onboard Devices Configuration		Page 1/1
Serial Port -----	[Enabled]	
Base Address -----	[3F8h]	
IRQ -----	[4]	
IrDA FIR -----	[Enabled]	
Base Address -----	[2F8h]	
IRQ -----	[11]	
DMA -----	[3]	
Parallel Port -----	[Enabled]	
Base Address -----	[378h]	
IRQ -----	[7]	
Operation Mode -----	[ECP]	
ECP DMA Channel -----	[1]	
↑↓ = Move highlight bar, ←→ = Change setting, F1 = Help		

The following table describes the parameters in this sub-menu. Settings in **boldface** are the default and suggested parameter settings.

Parameter	Description	Options
Serial Port	Enables or disabled the serial port. When enabled, you can set the base I/O address and interrupt request (IRQ) of the serial port.	Enabled or Disabled 3F8h , 3E8h, 2F8h or 2E8h 4 or 11
IrDA Port	Enables or disables the infrared port. When enabled, you can set the base I/O address, interrupt request (IRQ) and direct memory access (DMA) channel of the infrared port.	Enabled or Disabled 2F8h , 3E8h, 3F8h, or 2E8h 3 or 10
Parallel Port	Enables or disables the parallel port. When enabled, you can set the base I/O address, interrupt request (IRQ) and operation mode of the parallel port. If operation mode is set to ECP, the direct memory access (DMA) channel of the parallel port is set to 1.	Enabled or Disabled 378h , 278h, or 3BC h 7 or 5 ECP , EPP, Standard, or Bi-directional

System Security

The System Security sub-menu allows you to safeguard your computer and data with passwords and other security measures.

System Security		Page 1/1
Setup Password -----	[None]	
Power-on Password -----	[None]	
Hard Disk Password -----	[None]	
Processor Serial Number -----	[Enabled]	
↑↓ = Move highlight bar, ←→ = Change setting, F1 = Help		

The following table describes the parameters in this screen. Settings in **boldface** are the default and suggested parameter settings.

Parameter	Description	Options
Setup Password	When set, this password protects the computer and this BIOS Utility from unauthorized entry. See the following section for instructions on how to set a password.	Disabled or Enabled
Power-on Password	When set, this password protects the computer from unauthorized entry. See the following section for instructions on how to set a password.	Disabled or Enabled
Hard Disk Password	When set, this password protects the hard disk from unauthorized access. See the following section for instructions on how to set a password.	Disabled or Enabled
Processor Serial Number	The Pentium III processor includes a unique serial number which allows individual CPUs to be identified. You can turn off this feature by setting this parameter to Disabled.	Enabled or Disabled

Setting a password

Follow these steps:

1. Use the cursor up/down keys to highlight a Password parameter (Setup, Power-on or Hard Disk) and press the **Enter** key. The password box appears:
2. Type a password. The password may consist of up to seven characters (A-Z, a-z, 0-9).



Important! Be very careful when typing your password because the characters do not appear on the screen.

3. Press **Enter**. Retype the password to verify your first entry and press **Enter**.

After setting the password, the computer automatically sets the chosen password parameter to Present.

Removing a password

Should you decide to remove a password, do the following:

1. Use the **cursor up/down** keys to highlight a Password parameter (Setup, Power-on or Hard Disk).
2. Use the **cursor left** or **cursor right** key to remove the password.



Note: When you want to remove the Hard Disk password, you are prompted for the Hard Disk password before it is removed.

Changing a password

To change a password, follow these steps:

1. Remove the current password. See “Removing a password” on page 96.
2. Set a new password. See “Setting a password” on page 96.

Power Management

The Power Management screen contains parameters that are related to power-saving and power management.

Power Management		Page 1/1
System Resume Timer -----	[Disabled]	
System Resume Date -----	[----,----]	
System Resume Time -----	[--:--:--]	
Battery-low Warning Beep -----	[Enabled]	
Sleep Upon Battery-low -----	[Enabled]	
↑↓ = Move highlight bar, ←→ = Change setting, F1 = Help		

The following table describes the parameters in this screen. Settings in **boldface** are the default and suggested parameter settings.

Parameter	Description	Options or Format
System Resume Timer	When enabled and the system resume date and time are valid, the computer resumes (wakes up) at the set time and date.	Disabled or Enabled MMM DD,YYYY (day/month/year) HH:MM:SS (hour:minute:second)
Battery-low Warning Beep	Enables or disables warning beeps during a battery-low condition.	Enabled or Disabled
Sleep Upon Battery-low	Enables or disables the Hibernation function during a battery-low condition When the computer is very low on battery power, the computer will enter Hibernation mode if Sleep Manager is installed, active and the Hibernation file is valid. See “Sleep Manager” on page 74.	Enabled or Disabled

Load Default Settings

If you want to restore all parameter settings to their default values, select this menu item and press **Enter**. The following dialog box displays:

Do you want to load default settings?	
[Yes]	[No]

If you would like to load default settings for all parameters, use the **cursor left/right** keys to select **Yes**; then press **Enter**. Otherwise, choose **No**.



6 Troubleshooting

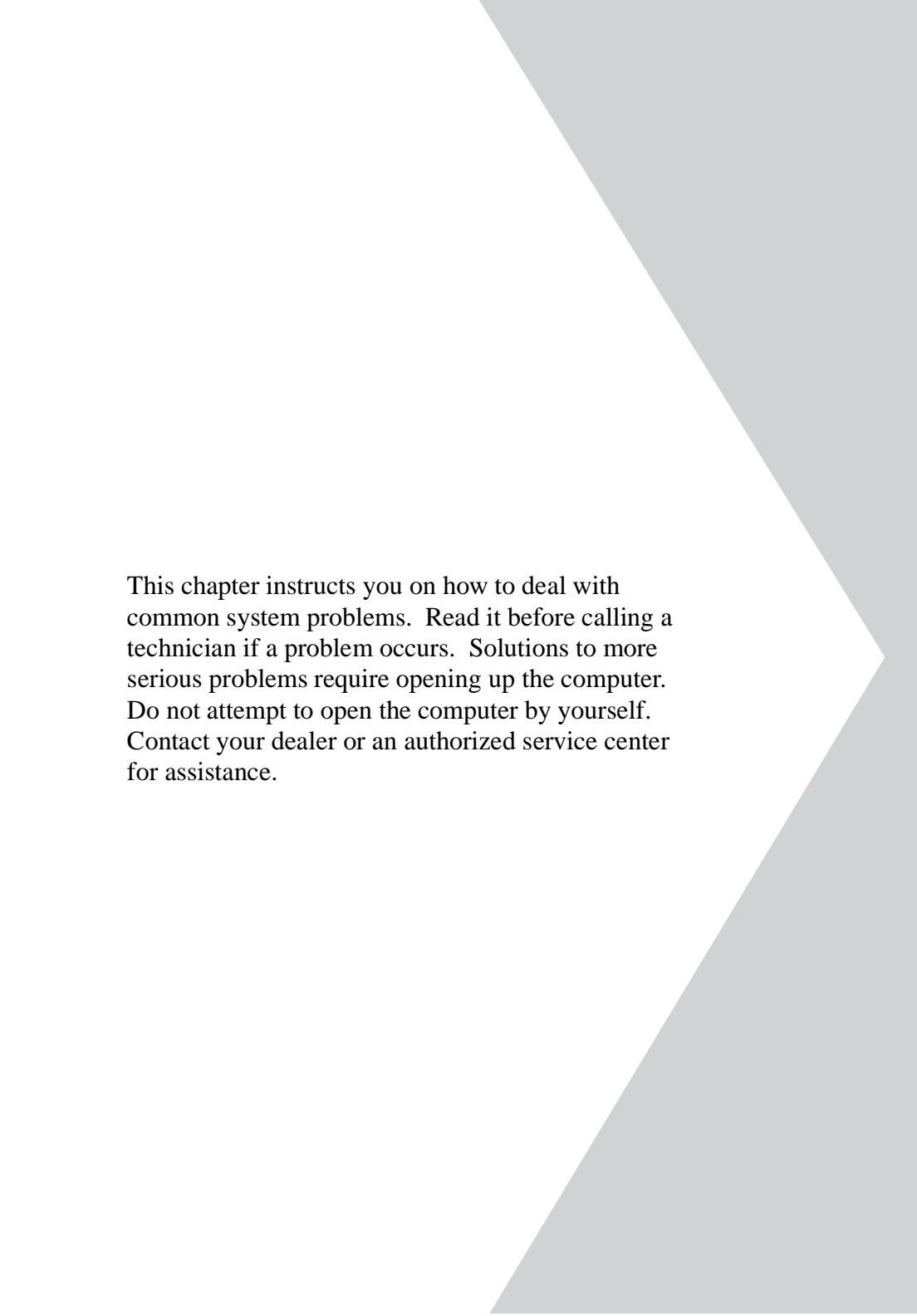

This chapter instructs you on how to deal with common system problems. Read it before calling a technician if a problem occurs. Solutions to more serious problems require opening up the computer. Do not attempt to open the computer by yourself. Contact your dealer or an authorized service center for assistance.

► Frequently-Asked Questions

The following is a list of possible situations that may arise during the use of your computer. Easy answers and solutions are provided for each one.

I pressed the power switch and opened the display, but the computer does not start or boot-up.

Look at the Power indicator:

- If it is not lit, no power is being applied to the computer. Check the following:
 - If you are running on battery power, it may be low and unable to power the computer. Connect the AC adapter to recharge the battery pack.
 - Make sure the AC adapter is plugged in properly to the computer and to the power outlet.
- If it is lit, check the following:
 - If the Standby indicator is lit, the computer is in Standby mode. Press any key or tap on the touchpad to resume.
 - Is a non-bootable (non-system) diskette in the floppy drive? Remove or replace it with a system diskette and press **Ctrl-Alt-Del** to restart the system.
- The operating system files may be damaged or missing. Insert the startup disk you created during Windows setup into the floppy drive and press **Ctrl-Alt-Del** to restart the system. This will diagnose your system and make necessary fixes.

Nothing appears on the screen.

The computer's power management system automatically blanks the screen to save power. Press any key to turn the display back on.

If pressing a key does not turn the display back on, two things might be the cause:

- The brightness level might be too low. Press **Fn→** (increase) and **Fn←** (decrease) to adjust the brightness level.
- The display device might be set to an external monitor. Press the display toggle hot key **Fn-F5** to toggle the display back to the computer.

Image is not full-screen.

Make sure the resolution is set to 800x600. Right-click on your Windows desktop and select Properties to bring up the **Display Properties** dialog box. Then click on the Settings tab to make sure the resolution is set to the appropriate resolution. Resolutions lower than the specified resolution are not full-screen on the computer or on an external monitor.

No audio is heard from the computer.

Check the following:

- The volume may be muted. In Windows, look at the volume control icon on the taskbar. If it is crossed-out, click on the icon and deselect the Mute option.
- The speakers may be turned off. Press **Fn-F8** to turn the speakers on (this hot key also turns the speakers off).
- The volume level may be too low. In Windows, look at the volume control icon on the taskbar. Click on the icon and adjust the level, or press the **Fn-↑** key.
- If headphones, earphones or external speakers are connected to the line-out port on the computer's right panel, the internal speakers automatically turn off.

I want to eject the CD-ROM or DVD-ROM tray without turning on the power. I cannot eject the CD-ROM or DVD-ROM tray.

There is a mechanical eject button on the CD-ROM or DVD-ROM drive. Simply insert the tip of a pen or paperclip and push to eject the tray.

The keyboard does not respond.

Try attaching an external keyboard to the PS/2 connector on the computer's rear. If it works, contact your dealer or an authorized service center as the internal keyboard cable may be loose.

The serial mouse does not work.

Check the following:

- Make sure that the serial cable is plugged securely into the serial port.
- During POST, press **F2** to access the BIOS Utility and verify that the serial port is enabled. See "Onboard Devices Configuration" on page 93 for details.

I prefer using an external keyboard and mouse, but both have PS/2 connectors and there is only one PS/2 port on the computer.

To connect two PS/2-type devices to the computer, you need to use a PS/2 Y-bridge connector. See “PS/2 y-bridge cable” on page 56 for details.

The printer does not work.

Check the following:

- Make sure that the printer is connected to a power outlet and it is turned on.
- Make sure the printer cable is connected securely to the computer’s parallel port and the corresponding port on the printer.
- During POST, press **F2** to access the BIOS Utility and verify that the parallel port is enabled. See “Onboard Devices Configuration” on page 93 for details.

The infrared port does not work.

Check the following:

- Make sure that the infrared ports of the two devices are facing each other (+/- 15 degrees) a maximum of 1 meter apart.
- Make sure there is a clear path between the two infrared ports. Nothing should be blocking the ports.
- Make sure you have the appropriate software running on both devices (for file transfers) or you have the appropriate drivers (for printing to an infrared printer).
- During POST, press **F2** to access the BIOS Utility and verify that the infrared port is enabled. See “Onboard Devices Configuration” on page 93 for details.
- Make sure both devices are IrDA-compliant.

I want to set up my location to use the internal modem.

To properly use your communications software (e.g., HyperTerminal), you need to set up your location:

1. Click on **Start, Settings, Control Panel**.
2. Double-click on **Modems**.
3. Click on **Dialing Properties** and begin setting up your location.

Refer to the Windows manual.

I get a “Not Enough Space for Allocation” error message from the Sleep Manager program.

This is an error message that may appear when Sleep Manager is creating the Hibernation file. There are several different reasons that may cause this error:

- The size of the free disk space on your hard disk is less than the required size.

For example, if the onboard memory is 32MB and the video memory is 2MB, the total free disk space required will be around 34MB. If the total free disk space is less than this, you have to free up space on the hard disk.

- The hard disk has enough free space, but this free space exists as small fragments.

The free disk space that Sleep Manager requires needs to be contiguous. To solve this problem, use tools such as Disk Defragmenter (Windows) to compact these free disk spaces. Then run Sleep Manager again to create the file.

- Disk compression utilities are used.

Sleep Manager can work with most compression software. However, Sleep Manager can only create the space on a host drive. A host drive stores original file information and cannot be compressed. The free space on the host drive is usually very small, so the compression software needs to be run again to enlarge the size of the host (uncompressed) drive for Sleep Manager.

For more information, see “Sleep Manager” on page 74.

► Troubleshooting tips

This notebook computer incorporates an advanced design that delivers onscreen error message reports to help you solve problems. In addition, this series of notebook computers ship with PC-Doctor, a powerful diagnostic tool, that helps you determine hardware configuration and clarify hardware or software problems.

- If the system reports an error message or an error symptom occurs, see “Error messages” on page 107.
- If you suspect the system has a problem, run PC-Doctor to diagnose it. See the following section.

Using PC-Doctor

Before running the program, take note of the following actions you may need to take:

1. Disconnect any external devices (i.e., PC Cards, external mouse).
2. Open System Properties to check and make sure the components you diagnose are enabled.

To open the System Properties window:

- a. Click on **Start, Settings, Control Panel**.
 - b. Double-click on **System**.
 - c. Click on the **Device Manager** tab.
3. Close all application programs (i.e., fax or communication programs) if you plan to diagnose the modem.

To run PC-Doctor, simply double-click on the **PC-Doctor** icon located on the Windows desktop. You can also access PC-Doctor by following these steps:

1. Click on **Start, Programs, PC-Doctor**.
2. Click on the **PC-Doctor** program.

If PC-Doctor does not report a system error, reinstall the software driver from the Recovery CD for the component you suspect has a problem. If you still have problems, you can access our online and Internet technical support services. Please see the following section for details.

► Online services

There are three ways to access Acer for technical support and information:

- Internet service worldwide, visit <http://www.acer.com/>
- Online service in the United States and Canada, call 1-800-816-2237
- Technical support numbers in various countries

You can view a list of technical support numbers by following these steps:

1. Click on **Start, Settings, Control Panel**.
2. Double-click on **System**.
3. Click on the **Support Information** button.

Before you call

Please have the following information available when you call Acer for online service, and please be at your computer when you call. With your support, we can reduce the amount of time a call takes and help solve your problems efficiently.

If there are error messages or beeps reported by your computer, write them down as they appear on the screen (or the number and sequence in the case of beeps).

If you are able to run the PC-Doctor diagnostic tests, locate the log file by selecting Windows, Test Log in the PC-Doctor menu bar.

If you haven't registered your notebook computer, you will be required to register during your first call to Acer.

You are required to provide the following information:

Name: _____

Address: _____

Telephone number: _____

Machine and model type: _____

Serial number: _____

Date of purchase: _____

▶ Error messages

If you receive an error message, note the message and take the corrective action. The following table lists the error messages in alphabetical order together with the recommended course of action.

Error Messages	Corrective Action
CMOS Battery Bad	Contact your dealer or an authorized service center.
CMOS Checksum Error	Contact your dealer or an authorized service center.
Disk Boot Failure	Insert a system (bootable) diskette in the floppy drive (A:), then press Enter to reboot.
Diskette Drive Controller Error or No Controller Present	Contact your dealer or an authorized service center.
Diskette Drive Error	Contact your dealer or an authorized service center.
Diskette Drive Type Mismatch	Press F2 (during POST) to enter the BIOS Utility; then press Esc to exit and reconfigure the computer.
Equipment Configuration Error	Press F2 (during POST) to enter the BIOS Utility; then press Esc to exit and reconfigure the computer.
Hard Disk 0 Error	Contact your dealer or an authorized service center.
Hard Disk 0 Extended Type Error	Contact your dealer or an authorized service center.
I/O Parity Error	Contact your dealer or an authorized service center.
Insert system diskette and press <Enter> key to reboot	Insert a system (bootable) diskette in the floppy drive (A:), then press Enter to reboot.
Keyboard Error or No Keyboard Connected	Contact your dealer or an authorized service center.
Keyboard Interface Error	Contact your dealer or an authorized service center.
Memory Size Mismatch	Press F2 (during POST) to enter the BIOS Utility; then press Esc to exit and reconfigure the computer.

Error Messages	Corrective Action
Missing operating system	Press F2 (during POST) to enter the BIOS Utility; then press Esc to exit and reconfigure the computer.
Non-system disk or disk error. Replace and strike any key when ready.	Insert a system (bootable) diskette in the floppy drive (A:), then press Enter to reboot.
Pointing Device Error	Contact your dealer or an authorized service center.
Pointing Device Interface Error	Contact your dealer or an authorized service center.
Protected Mode Test Fail	Contact your dealer or an authorized service center.
RAM BIOS Bad	Contact your dealer or an authorized service center.
RAM Parity Error	Contact your dealer or an authorized service center.
Real-Time Clock Error	Press F2 (during POST) to enter the BIOS Utility; then press Esc to exit and reconfigure the computer.
Video RAM BIOS Bad	Contact your dealer or an authorized service center.

If you still encounter problems after going through the corrective measures, please contact your dealer or an authorized service center for assistance. Some problems may be solved using the BIOS Utility. See “BIOS Utility” on page 88.



Appendix A
Specifications

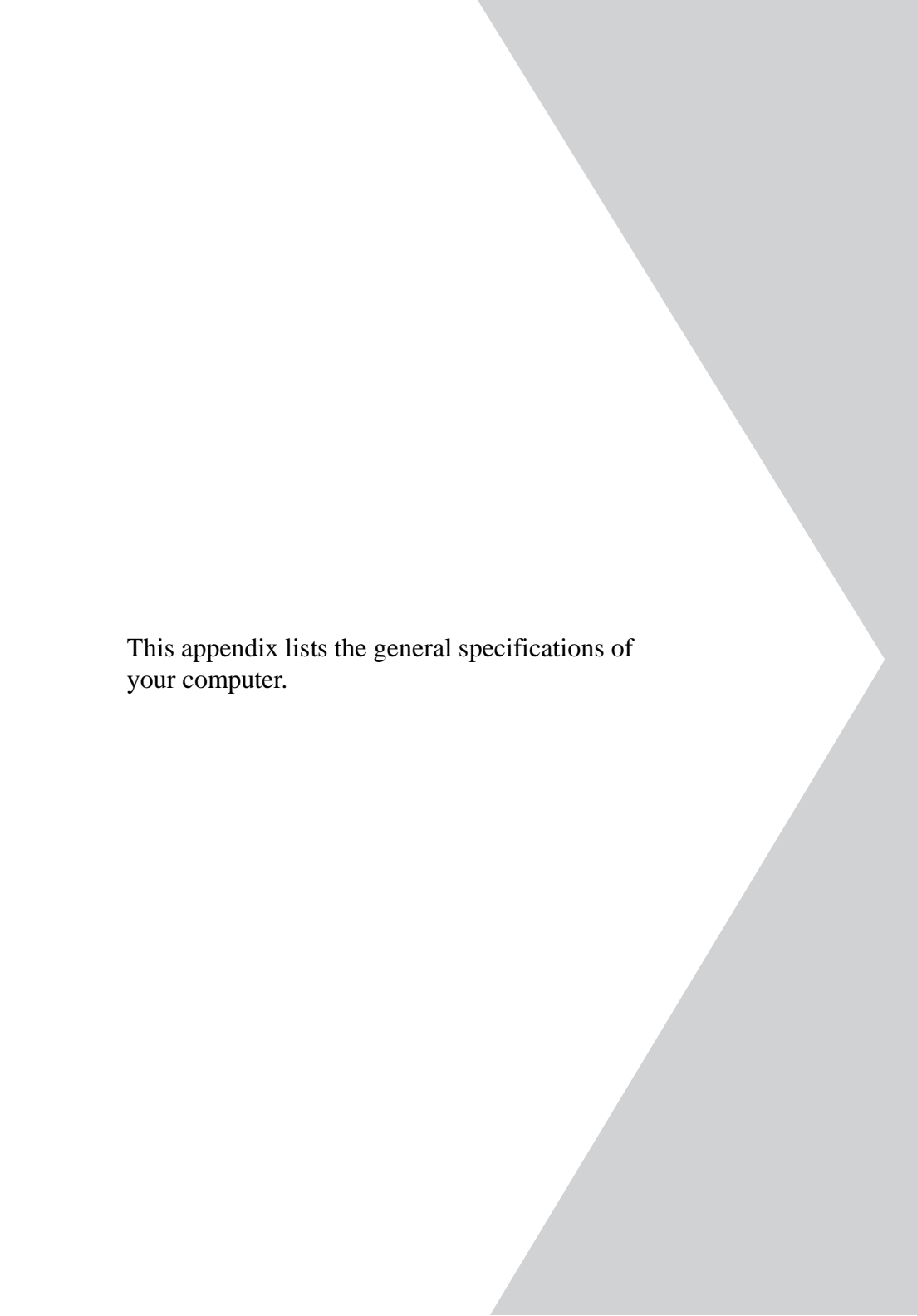

This appendix lists the general specifications of your computer.

Microprocessor

- Intel Pentium® III processor with 256KB L2 cache memory

Memory

- Main memory expandable to 256MB Synchronous Dynamic Random Access Memory (SDRAM)
- Two 144-pin industry-standard soDIMM sockets (one user-upgradeable socket)
- 64-bit dual memory banks
- 256KB Flash ROM BIOS

Data storage

- One 2.5-inch, 9.5mm removable hard disk
- One external EasyLink Combo Drive (floppy drive + CD-ROM or DVD-ROM drive)

Display and video

- 12.1-inch Thin Film Transistor LCD displaying 32-bit true-color at 800x600 SVGA resolution
- 64-bit graphics acceleration with 2.5MB Synchronous Dynamic Random Access Memory (SDRAM) and Accelerated Graphics Port (AGP)
- 3D features such as Goraud shading and Z-buffering
- Simultaneous LCD and CRT display
- Dualview capability
- DVD playback capability (with DVD-equipped EasyLink DVD Combo Drive option)

Audio

- 16-bit PCI stereo audio with built-in wavetable synthesizer
- Internal speaker
- Sound Blaster Pro- (DOS Emulation) and Windows Sound System-compatible
- Separate audio ports for line-out, line-in and microphone-in devices

Keyboard and pointing device

- 85-/89-key Windows keyboard
- Ergonomically-centered touchpad pointing device with scroll function

I/O ports

- One type II/I CardBus socket
- One RJ-11 modem jack (V.90-compliant 56Kbps)
- One RJ-45 network jack (Ethernet 10/100) — optional
- One power jack (DC-in)
- One FIR wireless communications port (IrDA-compliant)
- One 9-pin RS-232 serial port (UART16550-compatible)
- One 25-pin parallel port (ECP-compliant)
- One 15-pin external monitor port (DDC 2.0-compliant)
- One 6-pin keyboard/mouse port (PS/2-compatible)
- One EasyLink combo drive port
- One 3.5mm line-out minijack
- One 3.5mm line-in minijack
- One 3.5mm microphone-in minijack
- One USB jack

Weight and dimensions

- 1.8 kg (3.98 lbs)
- 289 x 219 x 23.5 mm (11.38 x 8.62 x 0.92 in)

Temperature

- Operating: 10°C ~ 35°C
- Non-operating: -20°C ~ 60°C

Humidity (non-condensing)

- Operating: 20% ~ 80% RH
- Non-operating: 20% ~ 80% RH

System

- Windows 98 or Windows NT operating system
- DMI 2.0-compliant
- LDCM support

Battery pack

- 30WattHour Lithium-Ion
- Smart battery management technology
- 2~3-hour rapid charge/6~7-hour charge-in-use

AC adapter

- 60-Watt
- Auto sensing 100~240Vac, 50~60Hz

Options

- 32-/64-/128-MB memory upgrade module
- Higher-capacity hard disk drive
- EasyLink DVD Combo Drive (floppy drive + DVD-ROM drive)
- PS/2 y-bridge cable
- Additional AC adapter and battery pack
- External battery charger
- USB video capture kit
- Mobile jacket cover accessory
- File transfer cable
- External numeric keypad
- In-air/auto adapter

Index

Numerics

- 3D enhanced function
 - enabling 27

A

- AC adapter
 - caring for xvii
 - connecting xiv
- ACPI. See Advanced Configuration and Power Interface
- Advanced Configuration and Power Interface 41
- Advanced Power Management 41
- APM. See Advanced Power Management
- audio 27
 - connecting externally 52
 - troubleshooting 102

B

- battery
 - installing xiii
- battery pack
 - battery-low warning 39
 - caring for xviii
 - characteristics 35
 - charging 37
 - charging indicator 7
 - charging modes 37
 - checking charge level 38
 - installing 36
 - low conditions 40
 - optimizing 38
 - removing 36
 - replacing 36
 - using the first time 35
- BIOS Utility 88– 98
 - Basic System Settings sub-menu 91
 - Load Default Settings sub-menu 98
 - Onboard Devices Configuration sub-menu 93
 - Power Management sub-menu 97
 - starting 88
 - Startup Configuration sub-menu 92
 - System Information sub-menu 89

- System Security sub-menu 95
- boot display device
 - setting in BIOS Utility 92
- boot drive sequence
 - setting in BIOS Utility 93
- boot order
 - setting in Notebook Manager 82
- brightness
 - hot keys 12
 - setting in Notebook Manager 87

C

- caps lock 8
 - on indicator 7
- care
 - AC adapter xvii
 - battery pack xviii
 - computer xvii
- CD-ROM
 - ejecting 18
 - ejecting manually 102
 - troubleshooting 102
- charging
 - checking level 38
 - modes 37
- cleaning
 - computer xviii
- computer
 - bringing to meetings 64
 - caring for xvii
 - cleaning xviii
 - connecting xiii
 - disconnecting 63
 - display 5
 - features 3
 - indicators 7
 - information 80
 - keyboards 8
 - moving around 64
 - on indicator 7
 - performance 3
 - power management 41
 - security 29
 - setting up a home office 67
 - taking home 66
 - traveling internationally 69
 - traveling on local trips 68
 - troubleshooting 100
 - turning off xv

- turning on xiv
 - connections
 - AC adapter xiv
 - audio 52
 - computer xiii
 - file transfer cable 57
 - keyboard, external 51
 - keypad, external 51
 - monitor 47
 - mouse 49
 - mouse, PS/2 49
 - mouse, serial 49
 - network 23
 - printer 48
 - PS/2 y-bridge cable 56
 - USB 54
 - contrast
 - setting in Notebook Manager 87
 - cover accessory 55
- D**
- date
 - setting in Setup Utility 91
 - diagnostics 105
 - diskette
 - ejecting 18
 - diskette drive 16
 - display 5
 - auto-dim feature 44
 - computer 5
 - hot keys 11
 - opening and closing 6
 - performance 5
 - power management 5, 44
 - setting boot device in Notebook Manager 87
 - setting in Notebook Manager 87
 - simultaneous 5
 - switching device in Notebook Manager 87
 - troubleshooting 101, 102
 - dualview
 - setting up 47

E

- EasyLink Combo Drive 16
- error messages 107
- Euro 12

F

- FAQ. See frequently-asked questions
- Fast Infrared. See infrared
- file transfer cable
 - connecting 57
- FIR. See infrared
- floppy disk
 - ejecting 18
- floppy drive 16
- frequently-asked questions 101

H

- hard disk 16
 - installing 59– 60
 - power management 44
 - upgrading 59
- help
 - Internet home page xvii
 - online manual xv
 - online services 106
 - technical support xvii
 - web page xvii
- Hibernation mode 43
 - conditions 43
 - entering 43
 - hot key 11
 - resuming from 43
 - utility 74
- hot keys 10

I

- indicator lights 7
- infrared 23
 - setting in BIOS Utility 94
 - troubleshooting 103
- ITW. See warranty

K

- keyboard 8
 - connecting externally 51
 - embedded numeric keypad 9
 - hot keys 10
 - lock keys 8
 - troubleshooting 102
 - Windows keys 10
- keyboard ergonomics 13
- keypad
 - connecting externally 51

L

LEDs 7

M

media access

on indicator 7

memory

installing 58– 59

upgrading 58

messages

error 107

mobile jacket 55

modem 22

monitor

connecting 47

mouse

connecting externally 49

troubleshooting 102

N

network 23

Notebook Manager 79– 87

Boot Sequence 82

Display Device 87

hot key 11

Information Viewer 80

Password 83

POST 81

Power Management 85

starting 79

notice

DVD copyright protection xii

year 2000 compliance xi

num lock 8

on indicator 7

numeric keypad

embedded 9

num lock 9

O

online services 106

options

cables 56

hard disk upgrade 59

memory upgrade 58

PC Cards 53

spare AC adapter 56

spare battery 56

P

palm rest 13

parallel port

setting in BIOS Utility 94

password 29

changing in Setup Utility 97

removing in Setup Utility 96

setting in Notebook Manager 84–
85

setting in Setup Utility 96

types 29

PC Card 24

ejecting 25

inserting 25

ports 20

left 20

rear 21

right 24

power

managing in BIOS Utility 97

managing in Notebook Manager 85

turning on xiv

power management 41

ACPI 41

advanced 41

schemes 44

power management modes

display standby mode 44

hard disk standby mode 44

Hibernation mode 43

sleep mode 42

Standby mode 42– 43

printer

connecting 48

troubleshooting 103

problems 101

CD-ROM 102

display 101, 102

infrared 103

keyboard 102

printer 103

serial mouse 102

Sleep Manager 104

startup 101

troubleshooting 100

PS/2 mouse

connecting 49

PS/2 y-bridge cable

connecting 56

Q

questions

multiple PS/2 devices 103
 setting location for modem use 103

S

safety

CD-ROM x
 FCC notice vii
 general instructions ix
 lithium battery xi
 modem notices viii

scroll lock 8

security

keylock 29
 passwords 29

serial mouse

connecting 49

serial port

setting in BIOS Utility 94

service

when to call xviii

Sleep Manager 74

troubleshooting 104

sleep mode 42

software

bundled 73

speakers

hot key 12
 troubleshooting 102

specifications 110

Standby mode 42– 43

entering 42

hot key 11

resuming from 43

signals 42

status indicator 7

status indicators 7

storage 16

EasyLink Combo Drive 16

floppy drive 16

hard disk 16

support

information xvi

T

time

setting in Setup Utility 91

touchpad 14

hot key 12

using 14– 15

travel

international flights 69

local trips 68

troubleshooting 100

tips 105

U

Universal Serial Bus 22

USB

connecting 54

video capture kit 54

USB. See Universal Serial Bus

utility

BIOS 88– 98

Notebook Manager 79– 87

Sleep Manager 74

V

videoconferencing 54

volume

hot keys 12

W

warranty

International Traveler's Warranty

xvi

Windows keys 10