

TravelMate α -550 series

User's guide

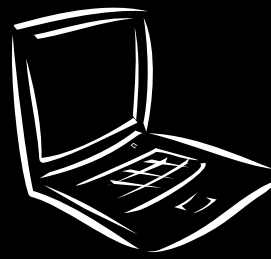



Copyright © 2001
All Rights Reserved

TravelMate α-550 series Notebook computer User's guide
Original Issue: October 2001

Changes may be made periodically to the information in this publication without obligation to notify any person of such revision or changes. Such changes will be incorporated in new editions of this manual or supplementary documents and publications. This company makes no representations or warranties, either expressed or implied, with respect to the contents hereof and specifically disclaims the implied warranties of merchantability or fitness for a particular purpose.

Record the model number, serial number, purchase date, and place of purchase information in the space provided below. The serial number and model number are recorded on the label affixed to your computer. All correspondence concerning your unit should include the serial number, model number, and purchase information.

No part of this publication may be reproduced, stored in a retrieval system, or transmitted, in any form or by any means, electronic, mechanical, photocopy, recording, or otherwise, without the prior written permission of Acer Incorporated.

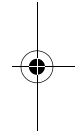
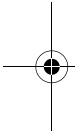

TravelMate α-550 series Notebook computer

Model Number : _____

Serial Number: _____

Purchase Date: _____

Place of Purchase: _____

All trademarks and registered trademarks are the properties of their respective companies.

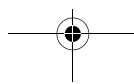

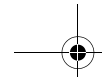

First things first

We would like to thank you for making the TravelMate series of notebook computers your choice for your mobile computing needs. We hope you will be happy with your TravelMate as much as we enjoyed making it for you.

Your guides

To help you use your TravelMate, we have designed a set of guides:



First off, the **Just for Starters...** poster helps you get started with setting up your computer.



This **User's guide** introduces you to the many ways your computer can help you be more productive. This guide provides clear and concise information about the computer, so read it thoroughly.



Lastly, there may be a **Read me first** sheet included with your package which contains important reminders and updates. So, please read through it.

For more information about our products, services, and support information, please visit our web site (www.acer.com).

Basic care and tips for using your computer

Turning your computer on and off

To turn on the computer, open the display cover, and press the power switch above the keyboard.

To turn the power off, do any of the following:

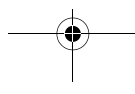



- Use the Windows shutdown command
Click on **Start**, and select the Windows shutdown or turn off command.
- Use the power switch
If you set the power switch to "Shut down", you can use this button to turn off the computer. See Windows help for details.



.....
Note: If you cannot power off the computer normally, press and hold the power switch for more than four seconds to shut down the computer. If you turn off the computer and want to turn it on again, wait at least two seconds before powering up.

Taking care of your computer

Your computer will serve you well if you take care of it.

- Do not expose the computer to direct sunlight. Do not place it near sources of heat, such as a radiator.
- Do not expose the computer to temperatures below 0°C (32°F) or above 50°C (122°F).
- Do not subject the computer to magnetic fields.
- Do not expose the computer to rain or moisture.
- Do not spill water or any liquid on the computer.
- Do not subject the computer to heavy shock and vibration.
- Do not expose the computer to dust and dirt.
- Never place objects on top of the computer to avoid damaging the computer.
- Do not slam the computer display when you close it.
- Never place the computer on uneven surfaces.

Taking care of your AC adapter

Here are some ways to take care of your AC adapter:

- Do not connect the adapter to any other device.
- Do not step on the power cord or place heavy objects on top of it. Carefully route the power cord and any cables away from personal traffic.
- When unplugging the power cord, do not pull on the cord itself

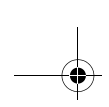

but pull on the plug.

- The total ampere ratings of the equipment plugged in should not exceed the ampere rating of the cord if you are using an extension cord. Also, the total current rating of all equipment plugged into a single wall outlet should not exceed the fuse rating.

Taking care of your battery pack

Here are some ways to take care of your battery pack:

- Use only batteries of the same kind as replacements. Turn the power off before removing or replacing batteries.
- Do not tamper with batteries. Keep them away from children.
- Dispose of used batteries according to local regulations. Recycle if at all possible.

Cleaning and servicing

When cleaning the computer, follow these steps:

- 1 Power off the computer and remove the battery pack.
- 2 Disconnect the AC adapter.
- 3 Use a soft cloth moistened with water. Do not use liquid or aerosol cleaners.

If any of the following occurs:

- The computer has been dropped or the body has been damaged.
- Liquid has been spilled into the product.
- The computer does not operate normally.

Please refer to "Troubleshooting my computer" on page 75.

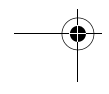
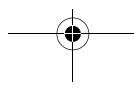
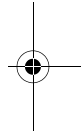
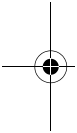

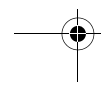
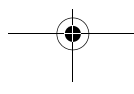
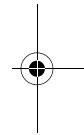
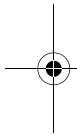
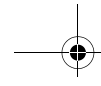



First things first	iii
Your guides	iii
Basic care and tips for using your computer	iii
1 Getting familiar with your computer	1
A tour of your computer	3
Front view	3
Left view	5
Right view	6
Rear view	7
Bottom view	8
Features	9
Display	11
Indicators	12
Keyboard	15
Special keys	15
Keyboard ergonomics	19
Touchpad	20
Touchpad basics	20
Launch keys	22
Storage	24
Connectivity options	25
Ethernet and LAN	25
Fax/data modem	25
Audio	26
Adjusting the volume	26
Using the Audio DJ feature	26
Securing your computer	27
Security notch	27
Passwords	27
2 Operating on battery power	29
Battery pack	31
Battery pack characteristics	31
Installing and removing the battery pack	31
Charging the battery	33
Checking the battery level	33
Optimizing battery life	33
Battery-low warning	34
Power management	36

Contents

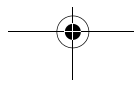
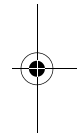
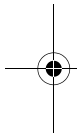

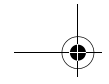

3 Peripherals and options	37
External display devices	39
External monitor	39
External display with s-video input	39
Using simultaneous display	39
External input devices	40
External keyboard	40
External keypad	40
External pointing device	40
Printer	41
Audio devices	42
Expansion devices	43
PC Card slots	43
USB	44
IEEE 1394	45
Miscellaneous options	46
Battery pack	46
AC adapter	46
Key component upgrades	47
Memory upgrade	47
Hard disk upgrade	49
4 Moving with your computer	51
Disconnecting from the desktop	53
Moving around	54
Preparing the computer	54
What to bring to short meetings	54
What to bring to long meetings	54
Taking the computer home	55
Preparing the computer	55
What to bring with you	55
Special considerations	55
Setting up a home office	56
Traveling with the computer	57
Preparing the computer	57
What to bring with you	57
Special considerations	57
Traveling internationally with the computer	58
Preparing the computer	58
What to bring with you	58
Special considerations	58

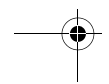
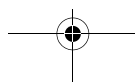
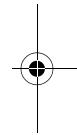
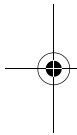

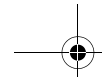

5 Software	59
System software	61
Easy Button	62
E-Mail Detector	63
BIOS Setup Utility	64
Main	65
System Devices	67
Security	68
Others	71
Boot	72
Exit	73
6 Troubleshooting	75
Frequently-asked questions	77
Error messages	81
Appendix A Specifications	85
Appendix B Notices	91
Index	99

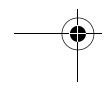
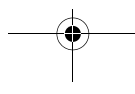
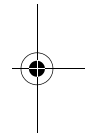
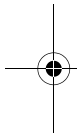

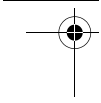

x

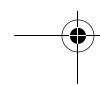
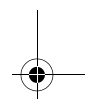
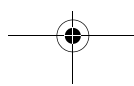
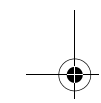
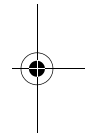
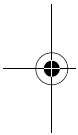
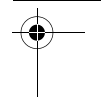
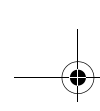

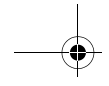

1 Getting familiar with your computer

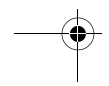
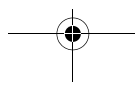
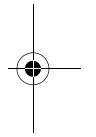
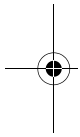

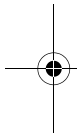
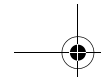

This computer combines high-performance, versatility, power management features and multimedia capabilities with a unique style and ergonomic design. Work with unmatched productivity and reliability with your new power computing partner.

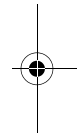

This chapter gives an in-depth "tour" of the computer's many features.

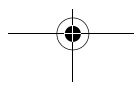

A tour of your computer

After setting up your computer as illustrated in the Just for Starters... poster, let us show you around your new notebook computer.

Front view

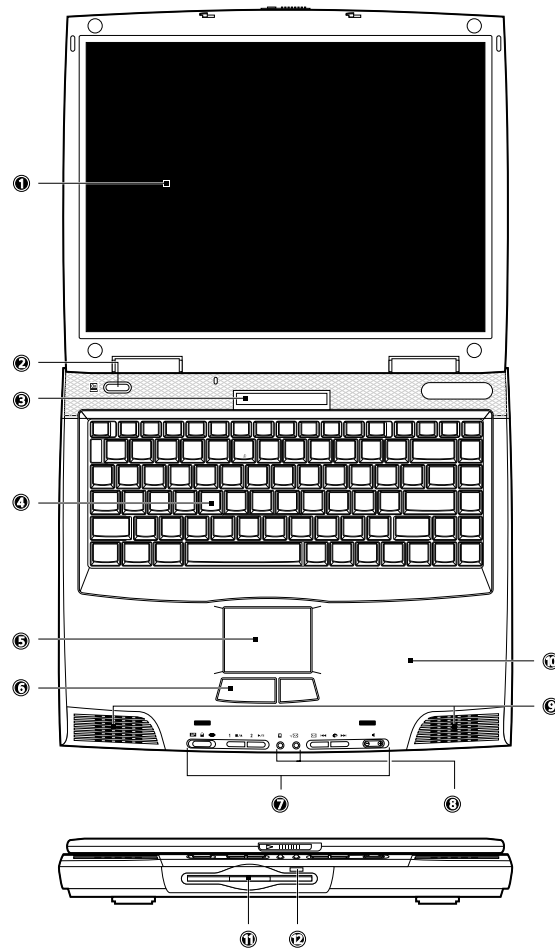



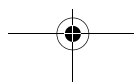
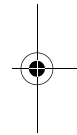
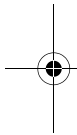

#	Item	Description
1	Display screen	Also called LCD (liquid-crystal display), displays computer output.
2	Power button	Turns on the computer power.
		
3	Status LCD	LCD that display icons to show the status of the computer and its functions and components.
4	Keyboard	Inputs data into your computer.
5	Touchpad	Touch-sensitive pointing device which functions like a computer mouse.
6	Click buttons (left and right)	The left and right buttons function like the left and right mouse buttons.
7	Launch keys	Buttons for launching frequently-used programs. See "Launch keys" on page 22 for more details.
8	Status indicators	Shows the power and email status.
9	Speakers	Outputs sound.
10	Palmrest	Comfortable support area for your hands when you use the computer.
11	Floppy drive	Accepts a 3.5-inch diskette.
12	Floppy drive eject button	Press to eject the diskette from the floppy drive.



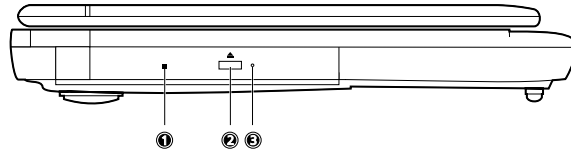





Left view

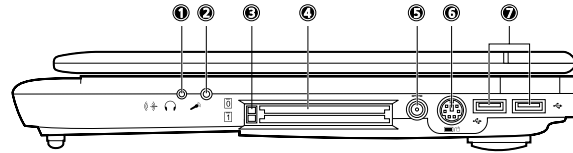

#	Item	Description
1	Optical drive	Depending on your model: <ul style="list-style-type: none"> • CD-ROM drive reads CDs • DVD-ROM drive reads CDs and DVDs • DVD/CD-RW combo drive reads CDs and DVDs, and writes to CD-Rs and CD-RWs.
2	Optical drive eject button 	Ejects the disc from the optical drive.
3	Optical drive emergency eject hole	Ejects the disc from the optical drive when the computer is turned off. See "How do I eject the optical drive tray with the computer turned off?" on page 78 for more details.





Right view

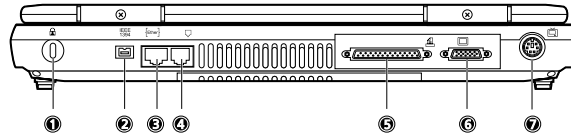

#	Item	Description
1	Speaker/headphone-out jack	Connects to audio line-out devices (e.g., speakers, headphones).
		
2	Microphone-in jack	Connects an external microphone.
		
3	PC Card eject buttons	Eject the selected PC Card from its slot.
4	PC Card slots	Accepts one Type III or two Type II/I PC Card(s).
		
5	DC-in jack	Connects to the AC adapter.
		
6	PS/2 port	Connects to a PS/2-compatible device (e.g., PS/2 keyboard/mouse/keypad).
		
7	USB ports (two)	Connects to USB devices (e.g., USB mouse).
		

Rear view



#	Item	Description
1	Security keylock 	Connects to a Kensington-compatible computer security lock.
2	IEEE 1394 port IEEE 1394	Connects to a IEEE 1394 compatible device (e.g., digital camcorder).
3	Network jack [Ether]	Connects to an Ethernet 10/100-based network.
4	Modem jack 	Connctns a phone line (only for models with an internal fax/data modem).
5	Parallel port 	Connects to a parallel device (e.g., parallel printer).
6	External display port 	Connects to a display monitor.
7	Video-out port 	Connects to a display device with S-video input.

Bottom view

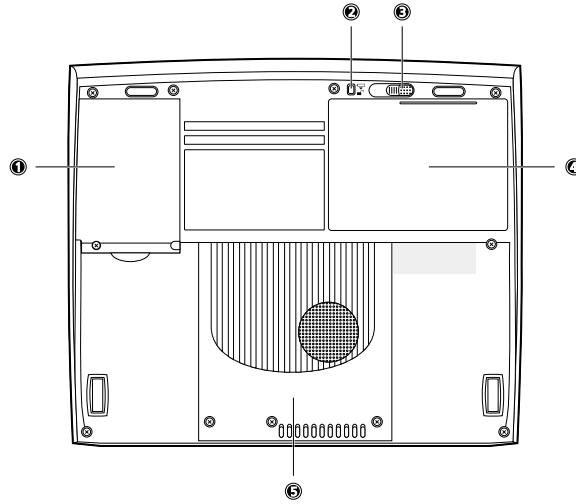

#	Item	Description
1	Hard disk bay	Houses the computer's hard disk.
2	Battery release button 	Press and hold to release the battery latch.
3	Battery release latch	Unlatches the battery to remove the battery pack.
4	Battery bay	Houses the computer's battery pack.
5	Memory compartment	Houses the computer's main memory.



Features

This computer was designed with the user in mind. Here are just a few of its many features:

Performance

- Intel® Pentium™ III or Intel® Celeron™ processor with on-die level 2 cache
- 128 MB memory onboard and one memory upgrade slot
- Large LCD display with adjustable video memory
- High-capacity, Enhanced-IDE hard disk
- Lithium-Ion battery pack
- Power management system
- DualView capability
- Simultaneous LCD and CRT display

Multimedia

- 16-bit high-fidelity stereo audio with 3-D sound
- Built-in dual stereo speakers
- Internal optical drive (CD-ROM, DVD-ROM, or DVD/CD-RW combo)
- Audio DJ (CD playback) feature
- S-video (NTSC/PAL) output

Connectivity

- High-speed 56Kbps V.90 fax/data software modem
- Ethernet/Fast Ethernet (10/100 Mbps)
- CardBus PC Card slots
- Universal Serial Bus (USB) ports
- IEEE 1394 port

Human-centric design and ergonomics

- All-in-one design (CD or DVD, floppy drive, and hard disk)
- Sleek, smooth and stylish design
- Full-sized keyboard
- Wide and curved palm rest

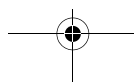
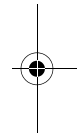
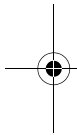

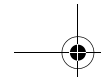

- Ergonomically-centered touchpad pointing device
- Launch keys (supports Audio DJ feature)

Expansion

- Upgradeable memory and hard disk

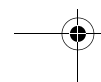
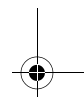
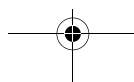
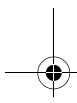
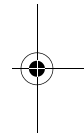
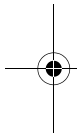

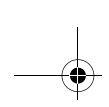

Display

The large graphics display offers excellent viewing, display quality and desktop-performance graphics. The computer supports a Thin-Film Transistor (TFT) liquid crystal display (LCD) displaying up to 16.7 million colors at 1400x1050 Super eXtended Graphics Array Plus (SXGA+) resolution (for models with a 15.0-inch display) or 1024x768 eXtended Graphics Array (XGA) resolution (for models with a 14.1-inch display).

Video performance

Video memory is adjustable via the BIOS Setup Utility. The system sets aside a portion of main memory for video. For more details on how to configure this setting, see "System Devices" on page 67.

Simultaneous display

The computer's large display and multimedia capabilities are great for giving presentations. If you prefer, you can also connect an external monitor when giving presentations. This computer supports simultaneous LCD and CRT display. Simultaneous display allows you to control the presentation from your computer and at the same time face your audience. You can also connect other output display devices such as an LCD projector or a television for large-audience presentations.

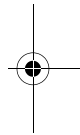
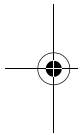

Indicators

The computer has an easy-to-read status LCD (1) located above the keyboard. Two status indicators, power (2), and email (3) are located near the front of the computer.

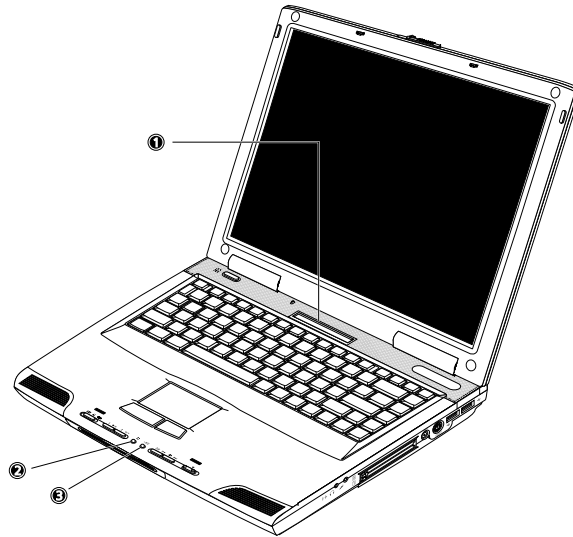



The status LCD displays icons that show the status of the computer and its components.

Function	Icon	Description
Caps lock		Caps Lock is activated.
Num lock		Numeric Lock (for embedded keypad) is activated.
Pad lock		Pad Lock (for embedded keypad) is activated.
Scroll lock		Scroll Lock is activated.

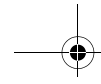
Function	Icon	Description
Optical drive/ Hard disk activity		CD or DVD drive or hard disk is being accessed.
Floppy drive activity		Floppy drive is being accessed.
PC Card activity		PC Card is being accessed.
AC power		Computer is running on AC power.
Battery charge	CHARGE	Battery is being charged.
Battery full	FULL	Battery is fully charged.
Battery gauge		Battery is 75 to 100 percent full.
		Battery is 31 to 74 percent full.
		Battery is 6 to 30 percent full, and battery is running low. Note: Charge the battery as soon as possible.
		Battery is critically-low. Note: Battery gauge icon is blinking.
		Battery temperature is too high. Note: Save your work and shut down your computer to let the battery cool down.



In addition to the status LCD, the computer includes power and email status indicators.

Function	Icon	Description
Power		Lights when the computer is on.
Email		Lights when incoming email is received. To launch your email program and read the incoming email, press the email button beside this indicator. See "Launch keys" on page 22.

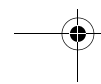
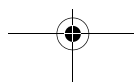
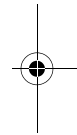
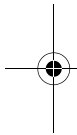

Keyboard

The keyboard has full-sized keys with an embedded keypad, separate cursor keys, two Windows keys and twelve function keys.

Special keys

Lock keys

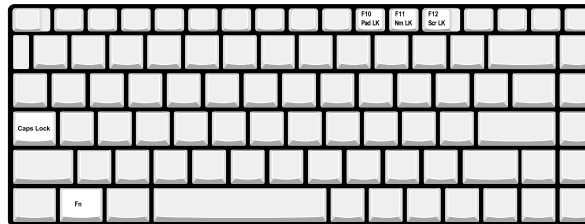

The keyboard has four lock keys which you can toggle on and off.

Lock Key	Description
Caps lock	When Caps Lock is on, all alphabetic characters typed are in uppercase.
Pad lock (Fn-F10)	When Pad Lock is on, the embedded keypad is in cursor mode. The keys function as a directional keypad including Insert and Delete keys.
Num lock (Fn-F11)	When Num Lock is on, the embedded keypad is in numeric mode. The keys function as a calculator (complete with the arithmetic operators +, -, *, and /). Use this mode when you need to do a lot of numeric data entry. A better solution would be to connect an external keypad. See "External keyboard" on page 40.
Scroll lock (Fn-F12)	When Scroll Lock is on, the screen moves one line up or down when you press ↑ or ↓ respectively. Scroll Lock does not work with some applications.



Embedded keypad

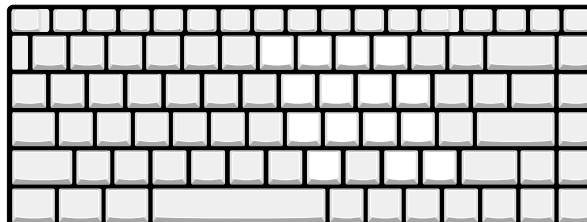

The embedded keypad functions like a desktop numeric keypad. It is indicated by small characters located on the lower edge of the keycaps. The embedded keypad can function in numeric mode or cursor-control mode.

Desired Access	Num lock On	Pad lock On
Number keys on embedded keypad	Type numbers in a normal manner.	Hold Shift while typing numbers.
Cursor-control keys on embedded keypad	Hold Shift while using cursor-control keys.	Use cursor-control keys in a normal manner.
Main keyboard keys	Hold Fn while typing letters on embedded keypad. Also hold down Shift for capital letters.	Hold Fn while typing letters on embedded keypad. Also hold down Shift for capital letters.

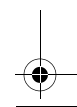
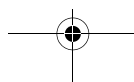
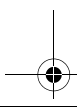
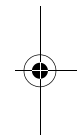
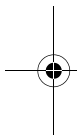



Windows keys

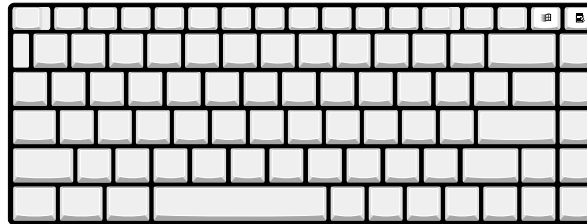

The keyboard has two keys that perform Windows-specific functions.

Key	Description
Windows logo key	Start button. Combinations with this key perform special functions. Below are a few examples: <ul style="list-style-type: none"> + Tab (Activates next Taskbar button) + E (Explores My Computer) + F (Finds Document) + M (Minimizes All) Shift + + M (Undoes Minimize All) + R (Displays Run dialog box)
Application key	Opens the application's context menu (same as right-click).

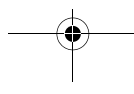
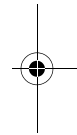
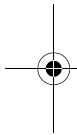



Hotkeys

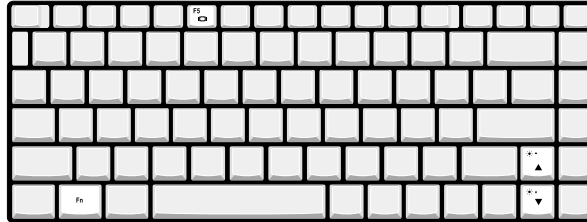

The computer uses hotkeys or key combinations to perform functions such as controlling the screen brightness and specifying where to display output.

HotKey	Function	Description
Fn-F5	Display toggle	Switches display output between the display screen, external monitor (if connected) and both the display screen and external monitor.
Fn-↑	Brightness up	Increases the screen brightness.
Fn-↓	Brightness down	Decreases the screen brightness.

When activating hotkeys, press and hold the **Fn** key before pressing the other key in the hotkey combination.

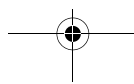
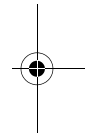
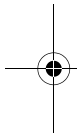

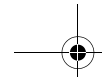

Keyboard ergonomics

Located below the keyboard, the wide and curved palm rest is ergonomically designed to provide you with a very comfortable place to rest your hands while you type.

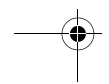
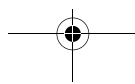
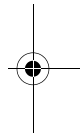
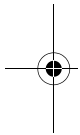



Touchpad

The built-in touchpad is a PS/2-compatible pointing device that senses movement on its surface. This means the cursor responds as you move your finger on the surface of the touchpad. The central location on the palm rest provides optimum comfort and support.



Touchpad basics

The following teaches you how to use the touchpad:

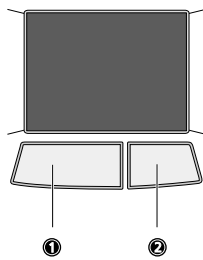

- Move your finger across the touchpad to move the cursor.
- Press the left (1) and right (2) buttons located on the edge of the touchpad to do selection and execution functions. These two buttons are similar to the left and right buttons on a mouse. Tapping on the touchpad produces similar results.

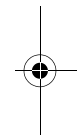
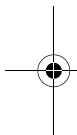



Function	Left Button	Right Button	Tap
Execute	Click twice quickly.		Tap twice (at the same speed as double-clicking the mouse button).
Select	Click once.		Tap once.
Drag	Click and hold, then use finger to drag the cursor on the touchpad.		Tap twice (at the same speed as double-clicking the mouse button) and hold finger to the touchpad on the second tap to drag the cursor.
Access context menu		Click once.	
Scroll			



Note: Keep your fingers dry and clean when using the touchpad. Also keep the touchpad dry and clean. The touchpad is sensitive to finger movements. Hence, the lighter the touch, the better the response. Tapping too hard will not increase the touchpad's responsiveness.

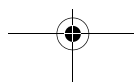
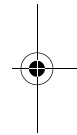
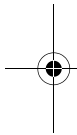

Launch keys

Located near the front end of the computer (between the speakers) are launch keys that perform various functions.

Depending on the set mode, these launch keys may be used to launch applications or play back music CDs.

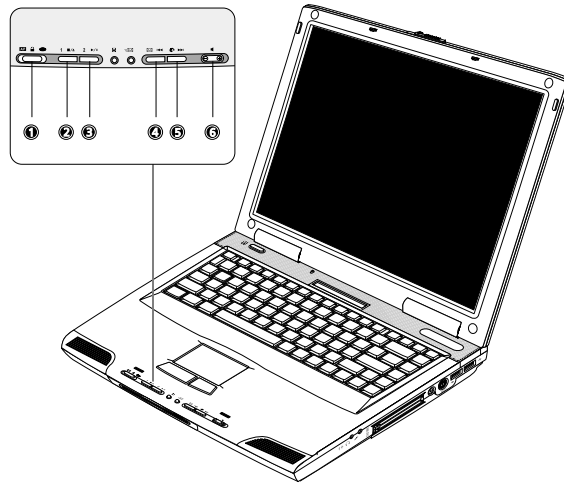

Note: The Audio DJ feature is also available even when the computer is off.

#	Item	Icon	Description
1	Mode switch		This sets the launch key mode. Slide the switch to the desired mode.
			AP (Application) mode
			Lock mode
			Audio DJ mode

#	Item	Icon	Description
2	1 (AP mode)	1	Launches a user-configurable application.
	Stop/Eject (Audio DJ mode)	■/▲	Stops playback of the music CD; when playback is stopped, ejects the drive tray.
3	2 (AP mode)	2	Launches a user-configurable application.
	Play/Pause (Audio DJ mode)	▶/	Plays and pauses playback of the music CD.
4	Email (AP mode)	✉	Launches your email program.
	Previous track (Audio DJ mode)	⏮	Jumps to the previous track on the music CD.
5	Internet browser (AP mode)	🌐	Launches your Internet browser.
	Next track (Audio DJ mode)	⏭	Jumps to the next track on the music CD.
6	Volume buttons		Decreases (-) or increases (+) the volume.

To configure the launch keys and the applications they launch, see “Easy Button” on page 62.

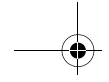

Storage

This computer's all-in-one design gives you the benefit of using the following media storage options:

- High-capacity Enhanced-IDE hard disk
The hard disk can be upgraded when you need more storage space. Consult your dealer for details.
- 3.5-inch floppy drive
The floppy drive reads and writes on standard 3.5-inch diskettes.
- High-speed optical drive
A high-speed optical drive (CD-ROM, DVD-ROM, or DVD/CD-RW) gives you portable multimedia access.

For the location of these drives, see "A tour of your computer" on page 3.

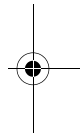
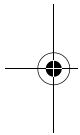

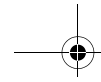

Connectivity options

The computer has built-in features for connecting to a network and communicating with other computers.

Ethernet and LAN

The built-in network feature allows you to connect your computer to an Ethernet-based (10/100 Mbps) network.

To use the network feature, connect an Ethernet cable from the network jack on the rear of the computer to a network jack or hub on your network. For the location of this port, see "Rear view" on page 7.

Fax/data modem

The computer has a built-in fax/data modem.



.....
Warning: This modem port is not compatible with digital phone lines. Plugging this modem into a digital phone line will damage the modem.

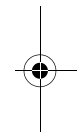
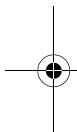

To use the fax/data modem port, connect a phone cable from the modem port to a telephone jack. For the location of this port, see "Rear view" on page 7.

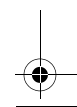
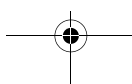
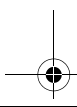

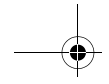

Audio

Your computer includes 16-bit high-fidelity stereo audio. The dual speakers, located near the front of the computer, direct sound towards you to further enhance sound output and quality.

There are audio ports on the right side of the computer. See "Right view" on page 6 for the location and description of these ports. For information on how to connect external audio devices to these ports, see "Audio devices" on page 42.

Adjusting the volume

Press the volume buttons to increase (+) or decrease (-) the volume. For the location of these buttons, see "Launch keys" on page 22.

Using the Audio DJ feature

The Audio DJ feature allows you to control the playback of music CDs even with the computer turned off. Do as follows:

- 1 Slide the launch key mode switch to Audio DJ mode. For the location of this switch, see "Launch keys" on page 22.



Note: If the computer is off, the power status indicator lights up.

- 2 Press the optical drive eject button; then pull out the drive tray.
- 3 Insert a music CD on the optical drive until it clicks in place on the spindle.
- 4 Close the optical drive tray securely.
- 5 You can now press the CD playback buttons to play the music CD.
Adjust the volume by pressing the volume buttons (+ to increase; - to decrease).

For more information on the CD playback buttons, see "Launch keys" on page 22.

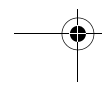
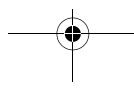
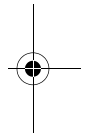
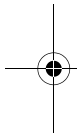



Securing your computer

Security features include hardware and software locks — a security notch and a password.

Security notch

A security notch located on the rear panel of the computer lets you connect a Kensington-compatible computer security lock. For the location of this notch, see “Rear view” on page 7.

Wrap a computer security lock cable around an immovable object such as a table or locked drawer handle. Insert the lock into the notch and turn the key to secure the lock. Some keyless models are available.

Passwords

The user password protects your computer and the BIOS Setup Utility from unauthorized access. When set with appropriate options enabled, no one can access the computer without entering the correct password.

See “BIOS Setup Utility” on page 64 for details on how to set a password and related options.



Important: Do not forget your password! If you forget your password, you need to contact your dealer.

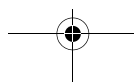
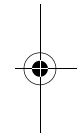
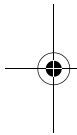

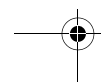
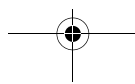
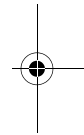
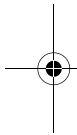
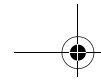

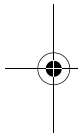
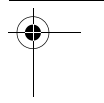
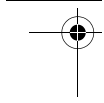
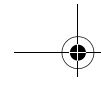

2 Operating on battery power

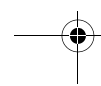
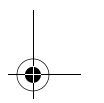
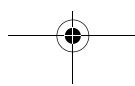
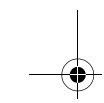
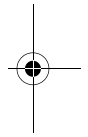

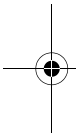
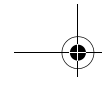

The computer operates on AC or battery power. This chapter contains the information you need to know to operate the computer on battery power. It also includes information on how your computer manages and saves power.

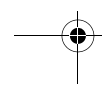
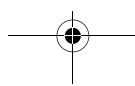
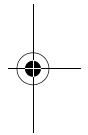



Battery pack

The computer uses a battery pack that gives you long use between charges.

Battery pack characteristics

The battery pack has the following characteristics:

- Employs current battery technology standards
- Battery-low warning

Whenever possible, use the AC adapter. The battery will come in handy when you travel or during a power failure. It is advisable to have an extra fully-charged battery pack available as backup. See your dealer for more details.

Using a battery pack for the first time

When using a battery pack for the first time, follow these steps:

- 1 Connect the AC adapter to a power source and to the computer and fully recharge the battery.
- 2 Disconnect the adapter to use up the battery before recharging again.

You only need to do this once or twice with a new battery or with a battery that's been stored without being used for a long time. If the computer is to be stored for more than two weeks, we suggest you remove the battery pack.



.....
Warning! Do not expose battery packs to temperatures below 0°C (32°F) or above 60°C (140°F). This may adversely affect the battery pack.

Installing and removing the battery pack



.....
Important! Before removing the battery pack, make sure that you have an AC adapter connected to the computer; otherwise, turn off the computer.



To install a battery pack:

- 1 Place the battery pack into the battery bay, connector-end first.
- 2 Press down on the battery pack until you hear the battery latch click in place.

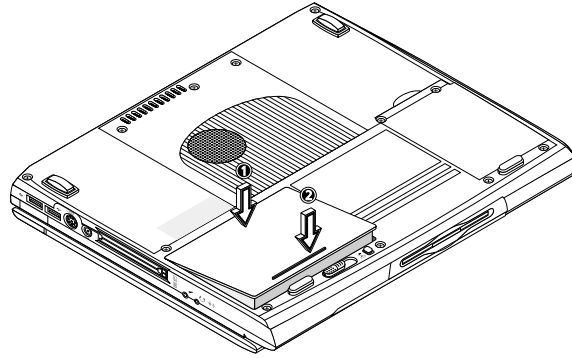

To remove the battery pack:

- 1 Press and hold the battery release button.
- 2 Slide the battery release latch to unlatch the battery pack.
- 3 Pull up the battery pack to remove it.

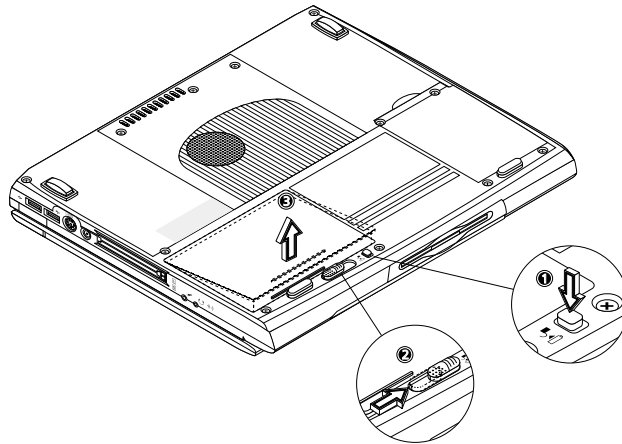

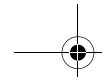

Charging the battery

To charge the battery, slide the battery pack into the battery bay and plug the AC adapter into the computer and an electrical outlet.

Charging modes

The adapter has two charging modes:

- **Rapid mode**
The computer uses rapid charging when power is turned off and a powered AC adapter is connected to it. In rapid mode, a fully depleted battery gets fully charged in approximately 3 hours.
- **Charge-in-use mode**
When the computer is in use with the AC adapter plugged in, the computer also charges the battery pack if installed. This mode will take longer to fully charge a battery than rapid mode. In charge-in-use mode, a fully depleted battery gets fully charged in approximately 4.5 hours.



Note: We suggest that you charge the battery pack before retiring for the day, letting it charge overnight before traveling. This ensures a fully charged battery for use the next day.

Checking the battery level

Using the Windows battery meter

The Windows battery meter indicates the present battery level. Simply rest your cursor on the battery meter (or AC plug) icon on the taskbar to see the present charge level of your battery.

Optimizing battery life

This section helps you get the most out of battery operation. Optimizing battery life prolongs the charge/recharge cycle and improves recharge efficiency. Follow these suggestions to optimize and maximize battery power:

- Purchase an extra battery pack.

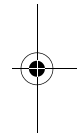
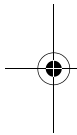



- Use the AC adapter whenever possible so that the battery is reserved for on-the-go computing.
- Keep the battery pack in the computer powered by the AC adapter. The constant trickle charge maintains the battery level to eliminate the battery self-discharge effect. The charge-in-use function also charges the battery pack.
- Disable the parallel port if no devices are connected to this port. You can do this through the BIOS Setup Utility. See "Others" on page 71.
- Eject the PC Card from the slot when it is not in use, since the PC Card draws extra power. See "Ejecting a card" on page 44.
- Store the battery pack in a cool, dry place. The recommended storage temperature for battery packs ranges from 10 to 30 degrees Celsius. The higher the storage temperature, the faster the battery pack self-discharges.
- The batteries can be recharged about 400 times when used as directed. Excessive recharging decreases battery life.
- Take care of your battery pack and AC adapter. See "Taking care of your computer" on page iv of the preface.

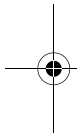

Battery-low warning

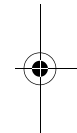

You never have to worry about battery power as long as you are using the AC adapter. However, when you operate the computer on battery power, pay extra attention to the battery gauge on the status LCD.



.....
Warning! Connect the AC adapter to the computer as soon as possible. Data is lost when computer power is cut off during Standby mode.

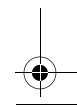
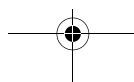
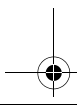

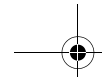

The following table shows the recommended course of action to take when you encounter a battery-low condition.

Situation	Recommended Action
AC adapter and power outlet available	<ol style="list-style-type: none">1. Connect the AC adapter to the computer.2. Save all necessary files.3. Resume work. Power off the computer if you wish to recharge the battery rapidly.
An extra fully-charged battery pack available	<ol style="list-style-type: none">1. Save all necessary files.2. Exit the application.3. Power off the computer.4. Replace the battery pack.5. Power on the computer and resume work.
AC adapter or power outlet not available	<ol style="list-style-type: none">1. Save all necessary files.2. Exit the application.3. Power off the computer.

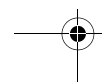
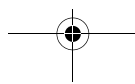
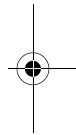
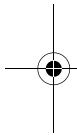

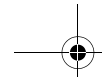

Power management

This computer has a built-in power management unit that monitors system activity. System activity refers to any activity involving one or more of the following devices: keyboard, mouse, floppy drive, hard disk, peripherals connected to the serial and parallel ports, and video memory. If no activity is detected for a period of time (called an inactivity timeout), the computer stops some or all of these devices in order to conserve energy.

This computer employs a power management scheme that supports ACPI (Advanced Configuration and Power Interface) which allows for maximum power conservation and maximum performance at the same time. ACPI enables Windows to control the amount of power given to each device attached to the computer. Windows handles all power-saving chores for your computer. For more information, refer to Windows help.

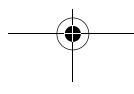
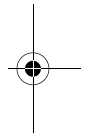
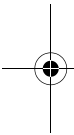

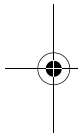
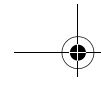

3 Peripherals and options

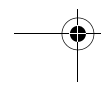
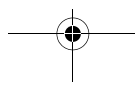
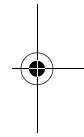



Your computer offers excellent expansion capabilities with its built-in ports and connectors. This chapter describes how to connect peripherals and hardware options that help you use your computer with ease. When connecting peripherals, read the manual included with the peripheral for operating instructions. You can purchase most of these and other options directly from authorized dealers.

This chapter also includes sections on how to upgrade key components. Key component upgradeability helps keep your computer in step with the latest technology.

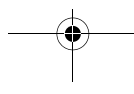
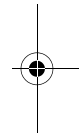
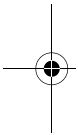

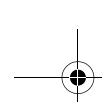

External display devices

External monitor

You can connect an external monitor to the external display port. For the location of these ports, see "Rear view" on page 7. Read the monitor manual for additional instructions.



Note: If an external monitor is not connected, closing the display cover puts the computer into Standby mode.

External display with s-video input

You can connect an external display device such as a television or projector with s-video input to the video-out port on the rear of the computer. For the location of this connector, see "Rear view" on page 7. Read the manual for your TV or projector for additional operating instructions.

Using simultaneous display

Your computer takes advantage of Windows multi-display capability, allowing you to use your computer for presentation purposes. So whatever is displayed in your computer will likewise be displayed on the other external display. Press **Fn-F5** to toggle the display output location.

To use simultaneous display, you can choose to connect the display device to the computer through the external display port or video-out port, depending on what your display device supports.

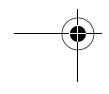
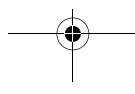
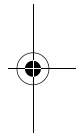
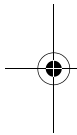

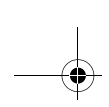

External input devices

External keyboard

This computer has a keyboard with full-sized keys and an embedded keypad. If you feel more comfortable using a desktop keyboard, you can connect an external PS/2-compatible or USB keyboard.

Plug a PS/2 keyboard into the PS/2 port; plug the USB keyboard to an available USB port. For the location of these ports, see "Right view" on page 6.

External keypad

You can also use a 17-key numeric keypad for number-sensitive, data-entry applications. To connect the keypad, plug the keypad connector into the PS/2 port or USB port depending on what your device supports. For the location of these ports, see "Right view" on page 6.

External pointing device

This computer accepts either a PS/2-compatible or USB mouse or similar pointing device. To use a PS/2-compatible mouse, simply plug it into the PS/2 port. If you use a USB mouse, connect it to an available USB port. For the location of these ports, see "Right view" on page 6.

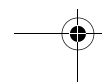
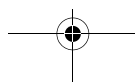
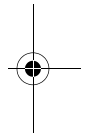
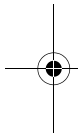

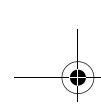

Printer

This computer supports both parallel and USB printers. For a parallel printer, plug the printer cable into the parallel port. For a USB printer, connect it to the USB port. For the location of these ports, see "Rear view" on page 7 and "Right view" on page 6.

To operate your printer, see your printer manual.



Note: If the printer does not function, enter the BIOS Setup Utility and verify that the parallel port is enabled. See "Others" on page 71 for assistance.

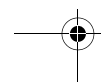
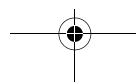
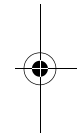
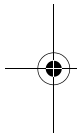

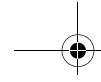

Audio devices

You can plug an external microphone into the microphone-in jack. Amplified speakers or headphones connect to the speaker/headphone-out jack. For the location of these ports, see "Right view" on page 6.

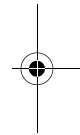
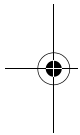

Expansion devices

PC Card slots

The computer has built-in CardBus PC Card slots that can accommodate one type III or two type II/I PC Cards. Please consult your dealer for PC Card options available that you can purchase for your computer.

The PC Card slots found on the right of the computer accepts credit-card-sized cards that enhance the usability and expandability of the computer.

PC Cards (formerly PCMCIA) are add-on cards for portable computers, giving you expansion possibilities long afforded by desktop PCs. Popular type II cards include flash memory, SRAM, fax/data modem, LAN and SCSI cards. CardBus improves on the 16-bit PC Card technology by expanding the data path to 32 bits.



.....
Note: Refer to your card's manual for details on how to install and use the card and its functions.

Inserting a card



.....
Note: Insert a type III PC Card in the lower slot.

Insert the card into the appropriate slot and make the proper connections (e.g., cable), if necessary. See your card manual for details.

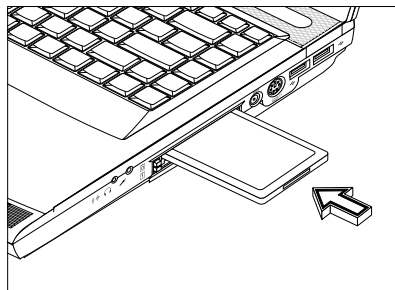

Ejecting a card

Before ejecting a PC Card:

- Exit the application using the card.
- Left-click on the Safely Remove Hardware icon on the taskbar and click on the safely remove card operation.

After it is safe to remove the card, press the slot eject button once to pop it out (1); then press it again to eject the PC Card (2).

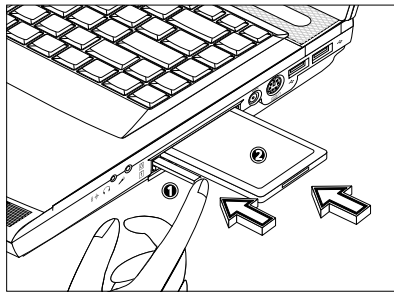

USB

The computer has two USB (Universal Serial Bus) ports that allow you to connect peripherals without occupying too many resources. USB devices are also plug and play which means you don't need to turn off your computer to connect and use the device. Common USB devices include the mouse, keyboard, and digital cameras. You can also daisy-chain USB devices via USB hubs.

For the location of these ports, see "Right view" on page 6.

Disconnecting USB devices

Before disconnecting a USB device:

- Stop all applications using the USB device.
- Left-click on the Safely Remove Hardware icon on the taskbar and click on the safely remove device operation.

Now you can unplug the USB device from the computer.

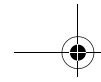

IEEE 1394

The computer's fast IEEE 1394 port allows you to connect IEEE 1394 supported devices like a digital camcorder, external hard disks, or external CD burners. You can also daisy-chain IEEE 1394 devices via a IEEE 1394 repeater.

For the location of these ports, see "Rear view" on page 7.

Disconnecting IEEE 1394 devices

Before disconnecting a IEEE 1394 device:

- Stop all applications using the IEEE 1394 device.
- Left-click on the Safely Remove Hardware icon on the taskbar and click on the safely remove device operation.

Now you can unplug the IEEE 1394 device from the computer.

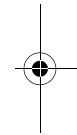
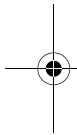



Miscellaneous options

Battery pack

It is a good practice to have a spare battery around, especially when you travel. The Li-ion battery, coupled with the power management features of your computer, supplies you with more power on-the-go.

AC adapter

The compact AC adapter charges your battery pack and supplies power to your computer. You can order a spare AC adapter so you do not need to carry it from the office to your home or destination.

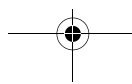
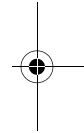
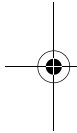



Key component upgrades

Your computer delivers superior power and performance. However, some users and the applications they use may demand more. This computer allows you to upgrade key components when you need increased performance.



Note: Contact your authorized dealer if you decide to perform a key component upgrade.

Memory upgrade

This notebook computer comes with one memory upgrade slot that accepts a soDIMM (Small Outline Dual Inline Memory Module). It supports PC-133 Synchronous Dynamic Random Access Memory (SDRAM).

Installing memory

Follow these steps to install memory:

- 1 Turn off the computer, unplug the AC adapter (if connected) and remove the battery pack. Then turn the computer over to access its base.

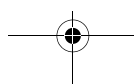
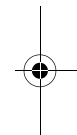
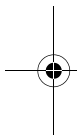

- 2 Remove the screws from the memory door (1), slide the memory door (2), then lift the memory door (3) to access the memory slot.

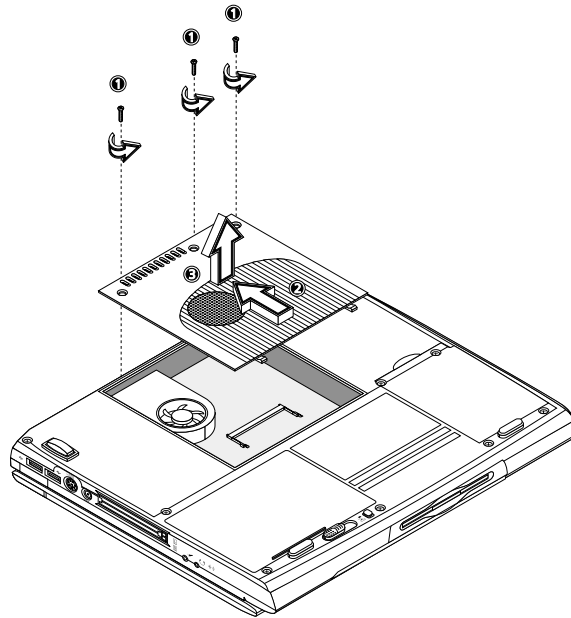

- 3 Insert the memory module diagonally into the slot (1), then gently press down until it clicks into place (2).

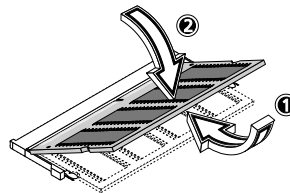

- 4 Replace the memory door and secure it with the screws.

The computer automatically detects and reconfigures the total memory size.



.....
Note: The system allocates a portion of main memory for video which can be adjusted in the BIOS Setup Utility. See "System Devices" on page 67 for details.

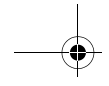

Hard disk upgrade

It is possible to upgrade your hard disk with a higher capacity drive when you need more storage space. The computer uses a 9.5mm 2.5-inch Enhanced-IDE hard disk. Please consult your dealer if you need to upgrade your hard disk.

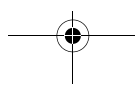
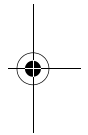
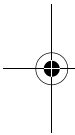

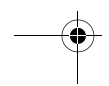
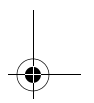
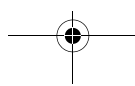
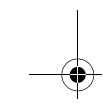
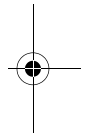
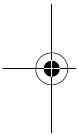
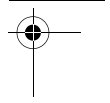
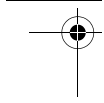
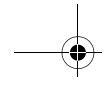

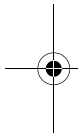
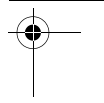
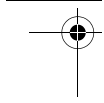
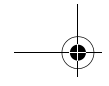

4 Moving with your computer

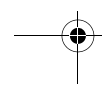
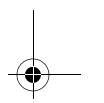
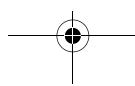
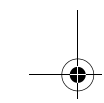
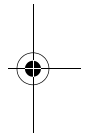

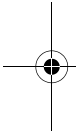
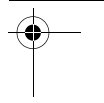
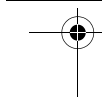
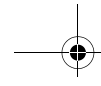

This chapter gives you tips and hints on things to consider when moving around or traveling with your computer.

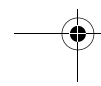
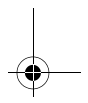
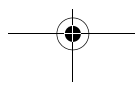
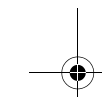
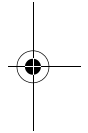

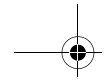

Disconnecting from the desktop

Follow these steps to disconnect your computer from external accessories:

- 1** Save your work in progress.
- 2** Shut down the operating system.
- 3** Turn off the computer.
- 4** Disconnect the cord from the AC adapter.
- 5** Disconnect the keyboard, pointing device, printer, external monitor, and other external devices.
- 6** Disconnect the Kensington lock if you are using one to secure the computer.

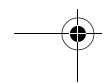
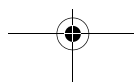
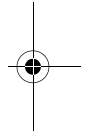
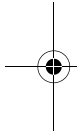

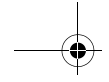

Moving around

when you are just moving within short distances, for example, from your office desk to a meeting room

Preparing the computer

Before moving the computer, close and latch the display cover to place it in Standby mode. You can now safely take the computer anywhere you go within the building.

To bring the computer out of Standby mode, open the display.

What to bring to short meetings

A fully charged battery runs the computer for 2 1/2 hours under most circumstances. If your meeting is shorter than that, you probably do not need to bring anything with you other than the computer.

What to bring to long meetings

If your meeting will last longer than 2 1/2 hours or if your battery is not fully charged, you may want to bring the AC adapter with you to plug in your computer in the meeting room.

If the meeting room does not have an electrical outlet, reduce the drain on the battery by putting the computer in power-saving mode. Close the display cover whenever you are not actively using the computer. Open the display to resume.

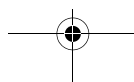
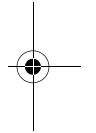
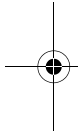



Taking the computer home

when you are moving from your office to your home or vice versa

Preparing the computer

After disconnecting the computer from your desktop, follow these steps to prepare the computer for the trip home:

- 1 Remove all media from the drives. Failure to remove the media can damage the drive head.
- 2 Pack the computer in a protective case that can prevent the computer from sliding around and cushion it if it should fall.



Caution: Avoid packing items next to the top cover of the computer. Pressure against the top cover could damage the screen.

What to bring with you

Unless you already have some items at home, bring the following items with you:

- AC adapter and power cord
- The printed user's manual

Special considerations

Follow these guidelines to protect your computer while traveling to and from work:

- Minimize the effect of temperature changes by keeping the computer with you.
- If you need to stop for an extended period of time and cannot bring the computer with you, leave the computer in the trunk of the car to avoid exposing the computer to excessive heat.
- Changes in temperature and humidity can cause condensation. Allow the computer to return to room temperature, and inspect the screen for condensation before turning on the computer. If the temperature change is greater than 18°F (10°C), allow the computer to come to room temperature slowly. If possible, leave



the computer for 30 minutes in an environment with a temperature between outside and room temperature.

Setting up a home office

If you frequently work on your computer at home, it may be worthwhile to purchase a second AC adapter for use at home. With a second AC adapter, you can avoid transporting the extra weight to and from home.

If you use your computer at home for significant periods of time, you might also want to add an external keyboard, monitor, or mouse.

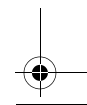
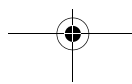
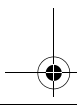
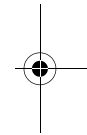
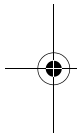

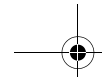

Traveling with the computer

when you are moving within a larger distance, for instance, from your office building to a client's office building or traveling locally

Preparing the computer

Prepare the computer as if you were taking it home. Be sure the battery in the computer is charged. Airport security may require you to turn on your computer when bringing it into the gate area.

What to bring with you

Bring the following items with you:

- AC adapter
- Spare, fully charged battery packs
- Additional printer driver files if you plan to use another printer

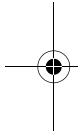

Special considerations

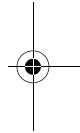

In addition to the guidelines for taking the computer home, follow these guidelines to protect your computer while traveling:

- Always take the computer as carry-on luggage.
- If possible, have the computer inspected by hand. The computer can safely pass through security X-ray machines, but never expose the computer to a metal detector.
- Avoid exposing floppy disks to hand-held metal detectors.

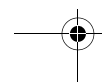
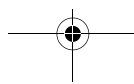



Traveling internationally with the computer

when you are moving from country to country

Preparing the computer

Prepare the computer as you would normally prepare it for traveling.

What to bring with you

Bring the following items with you.

- AC adapter
- Power cords that are appropriate to the country to which you are traveling
- Spare, fully charged battery packs
- Additional printer driver files if you plan to use another printer

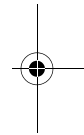
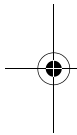

Special considerations

Follow the same special considerations as when traveling with the computer. In addition, these tips are useful when traveling internationally.

- When traveling in another country, check that the local AC voltage and the AC adapter power cord specifications are compatible. If not, purchase a power cord that is compatible with the local AC voltage (e.g., power rating). Do not use converter kits sold for appliances to power the computer.
- If you are using the modem, check if the modem and connector is compatible with the telecom system of the country you are traveling in.



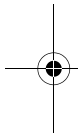
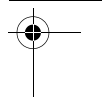
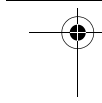
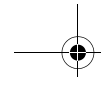

5 Software

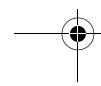
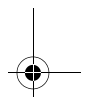
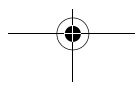
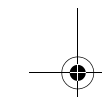
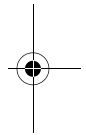

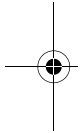
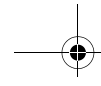

This chapter discusses the important system utilities bundled with your computer.

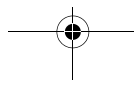
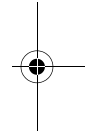

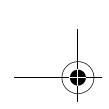

System software

The computer comes preloaded with the following software:

- Microsoft Windows operating system
- Hardware BIOS setup utility
- System utilities, drivers and application software



.....
Note: To access Windows software applications, click on the Start button and select the application folder. Then click on the application icon to run the selected application. To learn about the software and utility, make use of the online help provided by the software.

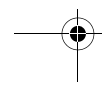
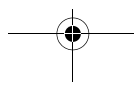
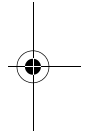
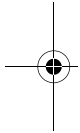



Easy Button

Easy Button allows you to set the four launch keys located near the front of the computer. See "Launch keys" on page 22 for the location of these keys.

To configure Easy Button, double-click on its icon on the taskbar. Pressing on a launch key that has not been configured will also allow you to configure Easy Button. To see other Easy Button options, right-click on the Easy Button icon on the taskbar.

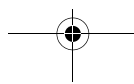
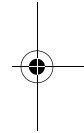
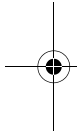

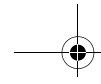

E-Mail Detector

The E-Mail Detector application monitors your mail servers for incoming email. When incoming email is detected, the email status indicator lights up. You can also set a notify message to appear or a sound to play when you receive incoming email.

To configure E-Mail Detector, double-click on its icon on the taskbar. To see other E-Mail Detector options, right-click on the E-Mail Detector icon on the taskbar.

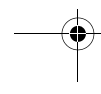
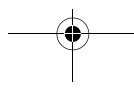
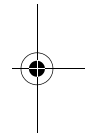
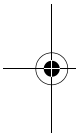

BIOS Setup Utility

The BIOS Setup Utility is a hardware configuration program built into your computer's BIOS (basic input/output system).

Your computer is already properly configured and optimized, and you do not need to run this utility. However, if you encounter configuration problems, you may need to run it. Please also refer to Chapter 6, Troubleshooting when a problem arises.

To activate the BIOS Setup Utility, press **F2** during POST.

Main	System Devices	Security	Others	Boot	Exit
					Item Specific Help
System Time:	[11:21:00]				
System Date:	[09/11/2001]				
Floppy Drive:	1.44MB, 3½"				
Hard Disk:	IBM-DJSA-220-(PM)				
Quiet Boot:	[Enabled]				
Power on display:	[Auto-Selected]				
LCD Display stretch:	[Enabled]				
System Memory:	640 KB				
Extended Memory:	113664 KB				
BIOS Ver.	V0.01				
F1 Help	↑↓ Select Item	F5/F6 Change Values	F9 Setup Defaults		
Esc Exit	←→ Select Menu	Enter Select > Sub-Menu	F10 Save and Exit		

Navigating the BIOS Setup Utility

There are six menu options: **Main**, **System Devices**, **Security**, **Others**, **Boot** and **Exit**.

Follow these instructions:

- To choose a menu, use the cursor left/right keys (← →).
- To choose a parameter, use the cursor up/down keys (↑↓).
- To change the value of a parameter, press **F5** or **F6**.



Note: You can change the value of a parameter if it is enclosed in square brackets.

- A plus sign (+) indicates the item has sub-items. Press **Enter** to expand this item.

- Press **Esc** while you are in any of the menu options to go to the Exit menu.
- In any menu, you can load default settings by pressing **F9**. You can also press **F10** to save any changes made and exit the BIOS Setup Utility.



Notes:

Navigation keys for a particular menu are shown on the bottom of the screen.

Help for parameters are found in the Item Specific Help part of the screen. Read this carefully when making changes to parameter values.

Main

The Main screen displays a summary of your computer hardware information, and also includes basic setup parameters.

Main	System Devices	Security	Others	Boot	Exit
System Time:	[11:21:00]				Item Specific Help
System Date:	[09/11/2001]				
Floppy Drive:	1.44MB, 3½"				
Hard Disk:	IBM-DJSA-220-(PM)				
Quiet Boot:	[Enabled]				
Power on display:	[Auto-Selected]				
LCD Display stretch:	[Enabled]				
System Memory:	640 KB				
Extended Memory:	113664 KB				
BIOS Ver.	V0.01				
F1 Help	↑↓ Select Item	F5/F6 Change Values	F9 Setup Defaults		
Esc Exit	←→ Select Menu	Enter Select > Sub-Menu	F10 Save and Exit		



Note: The screen above is for reference only. Actual values may differ.

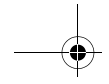

The table below describes the parameters in this screen. Settings in boldface are the default and suggested parameter settings.

Parameter	Description
System Time	Sets the system time. Format: HH:MM:SS (hour:minute:second)
System Date	Sets the system date. Format: MM/DD/YYYY (month/day/year)
Floppy Drive	Shows floppy drive type information.
Hard Disk	Shows the hard disk model.
Quiet Boot	Determines the way the system boots up. Options: Enabled or Disabled
Power on display	Determines the display device on startup. Options: Auto-Selected or Simultaneous
LCD Display stretch	Specifies whether or not to expand the image to fill the screen. Options: Enabled or Disabled
System Memory	Shows the amount of system memory.
Extended Memory	Shows the amount of extended memory
BIOS Ver.	Shows the system BIOS version.

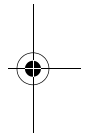
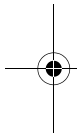

.....
Note: Main memory = system memory + extended memory

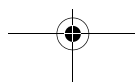

System Devices

The System Devices screen contains parameters involving your hardware devices.

Main	System Devices	Security	Others	Boot	Exit
					Item Specific Help
Pointing Device:		[Simultaneous]			
Ext. Keyboard "Fn":		[Enabled]			
IDE Controller:		[Both]			
FDD Controller:		[Enabled]			
Parallel Port:		[Enabled]			
Interrupt:		[IRQ 7]			
Mode:		[ECP]			
Base I/O address:		[378]			
DMA channel:		[DMA 3]			
VGA Frame Buffer Size:		[16 Mb]			
F1 Help	↑↓ Select Item	F5/F6 Change Values	F9 Setup Defaults		
Esc Exit	←→ Select Menu	Enter Select > Sub-Menu	F10 Save and Exit		

The table below describes the parameters in the screen. Settings in boldface are the default and suggested parameter settings.

Parameter	Description
Pointing Device	Determines whether or not to disable the internal touchpad if a PS/2 pointing device is connected. Options: Simultaneous or Auto-Selected
Ext. Keyboard "Fn"	Allows you to simulate an Fn key on an external keyboard by pressing the left Ctrl+left Alt keys. Options: Enabled or Disabled
IDE Controller	Enables or disables the primary or secondary IDE controller or both. Options: Both , Primary or Disabled
FDD Controller	Enables or disables the floppy drive controller. Options: Enabled or Disabled
Parallel Port	Enables or disables the parallel port. Options: Enabled or Disabled
IRQ	Sets the interrupt request of the parallel port. Options: IRQ 7 or IRQ 5

Parameter	Description
Mode	Sets the operation mode of the parallel port. Options: ECP , EPP or Bi-directional
Base I/O address	Sets the I/O address of the parallel port. This parameter is enabled only if Mode is set to ECP or Bi-directional. Options: 378 , 278 or 3BC
DMA Channel	Sets a DMA channel for the printer to operate in ECP mode. This parameter is enabled only if Mode is set to ECP. Options: 3 or 1
VGA Frame Buffer Size	Specifies the amount of main memory to allocate for VGA. Options: 16 Mb , 32 Mb or 8 Mb



Note: VGA takes up a portion of system memory, configurable via the VGA Frame Buffer parameter. For example, if you have 128 MB SDRAM, and you set a VGA Frame Buffer of 16 MB, main memory is 112 MB.

Security

The Security screen contains parameters that help safeguard and protect your computer from unauthorized use.

Main	System Devices	Security	Others	Boot	Exit
					Item Specific Help
User Password:	Clear				
Set User Password:	[Enter]				
Password on boot:	[Disabled]				
F1 Help Esc Exit	↑↓ Select Item ←→ Select Menu	F5/F6 Change Values Enter Select > Sub-Menu	F9 Setup Defaults F10 Save and Exit		

The table below describes the parameters in this screen. Settings in boldface are the default and suggested parameter settings.

Parameter	Description
User Password	Shows the setting of the user password. Options: Clear or Set
Set User Password	Press Enter to set the user password. When set, this password protects the BIOS Setup Utility from unauthorized access.
Password on boot	When enabled, the user password protects the computer from unauthorized access during boot up. Options: Disabled or Enabled



Notes:

When you are prompted to enter a password, you have three tries before the system halts.

Don't forget your password. If you forget your password, you may have to return your notebook computer to your dealer to reset it.

Setting a password

Follow these steps:

- 1 Use the \uparrow and \downarrow keys to highlight the Set User Password parameter and press the **Enter** key. The Set Password box appears:

Set Password	
Enter new password:	[]
Confirm new password:	[]

- 2 Type a password in the Enter new password field. The password may consist of up to eight alphanumeric characters (A-Z, a-z, 0-9).



Important: Be very careful when typing your password because the characters do not appear on the screen.

Retype the password in the Confirm new password field.



3 Press **Enter**.

After setting the password, the computer sets the User Password parameter to "Set".

4 If desired, you can opt to enable the Password on boot parameter.

5 When you are done, press **F10** to save the changes and exit the BIOS Setup Utility.

Removing a password

Follow these steps:

1 Use the **↑** and **↓** keys to highlight the Set User Password parameter and press the **Enter** key. The Set Password box appears:

Set Password		
Enter Current Password	[]
Enter New Password	[]
Confirm New Password	[]

2 Type the current password in the Enter Current Password field and press **Enter**.

3 Press **Enter** twice without typing anything in the Enter New Password and Confirm New Password fields.

The computer then sets the User Password parameter to "Clear".

4 When you are done, press **F10** to save the changes and exit the BIOS Setup Utility.

Changing a password

Follow these steps:

1 Use the **↑** and **↓** keys to highlight the Set User Password parameter and press the **Enter** key. The Set Password box appears:

Set Password		
Enter Current Password	[]
Enter New Password	[]
Confirm New Password	[]

2 Type the current password in the Enter Current Password field and press **Enter**.

3 Type a password in the Enter new password field.

Retype the password in the Confirm new password field.

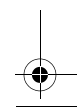
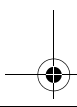
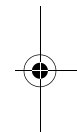
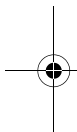

4 Press **Enter**.

After setting the password, the computer sets the User Password parameter to "Set".

5 If desired, you can opt to enable the Password on boot parameter.

6 When you are done, press **F10** to save the changes and exit the BIOS Setup Utility.

Others

The Others screen contains various parameter settings.

Main	System Devices	Security	Others	Boot	Exit
					Item Specific Help
Low Battery Alarm:		[Enabled]			
Panel Close Alarm:		[Disabled]			
System Beep:		[Enabled]			
Installed O/S:		[Win98/Me/ZK/XP]			
F1 Help ↑↓ Select Item F5/F6 Change Values F9 Setup Defaults Esc Exit ←→ Select Menu Enter Select > Sub-Menu F10 Save and Exit					

The table below describes the parameters in this screen. Settings in boldface are the default and suggested parameter settings.

Parameter	Description
Low Battery Alarm	Determines whether or not the system will alarm when the battery power is low. Options: Enabled or Disabled
Panel Close Alarm	Determines whether or not the system will alarm when the display cover is closed. Options: Disabled or Enabled
System Beep	Determines whether or not the system will emit a beep on boot up. Options: Enabled or Disabled

Parameter	Description
Installed O/S	Sets the operating system in use. Options: Win98/Me/2K/XP or Only Win NT4.0

Boot

The Boot screen allows you to set the order in which the system looks for bootable devices on startup.

Main	System Devices	Security	Others	Boot	Exit
+Removable Devices +Hard Drive CD-ROM/DVD Drive					Item Specific Help
F1 Help Esc Exit	↑↓ Select Item ←→ Select Menu	F5/F6 Change Values Enter Select > Sub-Menu	F9 Setup Defaults F10 Save and Exit		

The table below describes these devices.

Parameter	Description
Removable Devices	The computer attempts to boot from the removable device (e.g., floppy drive). If unsuccessful, the system goes to the next device in the list.
Hard Drive	The computer attempts to boot from the hard disk. If unsuccessful, the system goes to the next device in the list.
CD-ROM/DVD Drive	The computer attempts to boot from the CD or DVD drive (looks for a bootable CD or DVD).



Note: A plus (+) sign may be shown in front of a device. You can press **Enter** to “expand” the device and see sub-items in this category.

Exit

The Exit screen contains parameters that help safeguard and protect your computer from unauthorized use.

Main	System Devices	Security	Others	Boot	Exit
Exit Saving Changes Exit Discarding Changes Load Setup Defaults Discard Changes Save Changes					Item Specific Help
F1 Help Esc Exit	↑↓ Select Item ←→ Select Menu	F5/F6 Change Values Enter Execute Command		F9 Setup Defaults F10 Save and Exit	

The table below describes the parameters in this screen.

Parameter	Description
Exit Saving Changes	Saves changes made and exits the BIOS Setup Utility (same as F10).
Exit Discarding Changes	Discards changes made and exits the BIOS Setup Utility.
Load Setup Defaults	Loads default settings for all parameters (same as F9).
Discard Changes	Discards changes made.
Save Changes	Saves changes made.



Note: In any menu, you can load default settings by pressing F9. You can also press F10 to save any changes made and exit the BIOS Setup Utility.

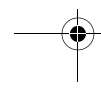
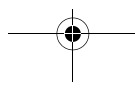
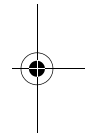
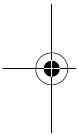
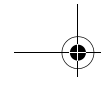

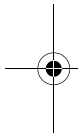
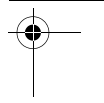
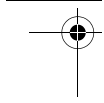
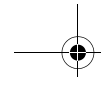

6 Troubleshooting

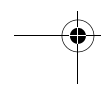
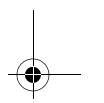
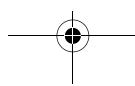
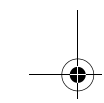
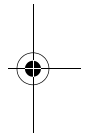

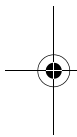

This chapter instructs you on how to deal with common system problems. Read it before calling a technician if a problem occurs. Solutions to more serious problems require opening up the computer. Do not attempt to open and service the computer by yourself. Contact your dealer or an authorized service center for assistance.

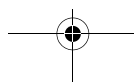
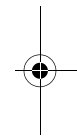



Frequently-asked questions

This is a list of possible situations that may arise during the use of your computer, and it gives easy answers and solutions to these questions.

I press the power switch, but the computer does not start or boot-up.

Look at the Power status indicator:

- If it is not lit, no power is being applied to the computer. Check the following:
 - If you are running on battery power, it may be low and unable to power the computer. Connect the AC adapter to recharge the battery pack.
 - Make sure the AC adapter is plugged in properly to the computer and to the power outlet.
- If it is lit, check if a non-bootable (non-system) diskette is in the floppy drive. Remove or replace it with a system diskette and press **Ctrl-Alt-Del** to restart the system.

The operating system files may be damaged or missing. Insert the startup disk you created during Windows setup into the floppy drive and press **Ctrl-Alt-Del** to restart the system. This will diagnose your system and make necessary fixes.

Nothing appears on the screen.

The computer's power management system automatically blanks the screen to save power. Press any key to turn the display back on.

If pressing a key does not turn the display back on, two things might be the cause:

- The brightness level might be too low. Press **Fn-↑** and **Fn-↓** to adjust the brightness level.
- The display device might be set to an external monitor. Press the display toggle hot key **Fn-F5** to toggle the display back to the computer.

Image is not full-screen.

Make sure the resolution is set to a resolution your system supports natively. Right-click on your Windows desktop and select Properties to bring up the Display Properties dialog box. Then click on the Settings

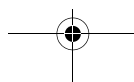
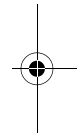
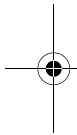

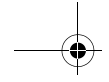

tab to make sure the resolution is set to the appropriate resolution. Resolutions lower than the specified resolution are not full-screen on the computer or on an external monitor.

No audio from the computer.

Check the following:

- The volume may be muted. In Windows, look at the volume control icon on the taskbar. If it is crossed-out, click on the icon and deselect the Mute option.
- The volume level may be too low. In Windows, look at the volume control icon on the taskbar. Click on the icon and adjust the level. You can also use the volume control knob on the front panel of the computer to adjust the volume.

If headphones, earphones or external speakers are connected to the speaker/headphone-out port on the computer, the internal speakers automatically turn off.

External microphone does not work.

Check the following:

- Make sure the external microphone is connected to the microphone-in jack on the computer.
- If you cannot hear playback, the speakers may be muted.

How do I eject the optical drive tray with the computer turned off?

There is a emergency eject hole on the optical drive. Simply insert the tip of a pen or paperclip and push to eject the optical drive tray. For the location of the emergency eject hole, see "Left view" on page 5.

The keyboard does not respond.

Try attaching an external PS/2 or USB keyboard to the appropriate port on the computer. If it works, contact your dealer or an authorized service center as the internal keyboard cable may be loose.

The floppy drive cannot access a diskette.

Check the following:

- Make sure the diskette is properly inserted in the floppy drive.
- Make sure the diskette is formatted.

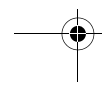
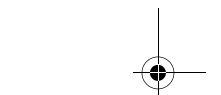
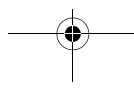
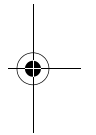
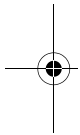

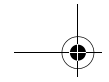

- If the diskette is not the cause of the problem, the floppy drive may be dirty. Clean it using a drive cleaning kit. Follow the instructions included with the kit.

The CD or DVD drive cannot access a disc.

Check the following:

- Make sure the disc is supported by the drive. If your computer has a CD-ROM drive, it can read CDs but cannot read DVDs. If your computer has a DVD drive, it can read DVDs in addition to CDs.
- When placing the CD or DVD in the drive tray, make sure it is secure in the spindle on the drive tray.
- Make sure the CD or DVD is free from scratches or smudges. If the CD or DVD is dirty, clean it using a disc cleaning kit. Remember to follow the instructions included with the kit.
- If the problem does not lie with the disc, your CD or DVD drive may be dirty. Clean it using a drive cleaning kit. Follow the instructions included with the kit.

The printer does not work.

Check the following:

- Make sure that the printer is connected to a power outlet and it is turned on.
- Depending on your printer connection (USB or parallel), make sure the printer cable is connected securely to the appropriate ports on both the computer and the printer.
- If you use a parallel port, access the BIOS Setup Utility by pressing **F2** after restarting your system. Go to the **Others** screen and verify that the parallel port is enabled. See "Others" on page 71.

I want to set up my location to use the internal modem.

Follow these steps:

- 1 Click on **Start**, then click **Control Panel**.
- 2 Double-click on **Phone and Modem Options**.
- 3 In the Dialing Rules tab, begin setting up your location.

Refer to the Windows Help and Support and the modem manual.

Why can't I charge my battery to 100% charged when it is 99-95%

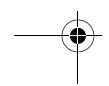
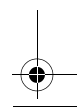
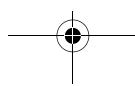
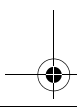
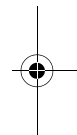
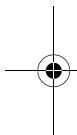



charged?

To preserve the life of the battery, the system only lets you charge the battery when its capacity falls below 95%. However, it is recommended that you bring an extra battery and let the battery in the system use up its power before charging it.

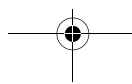
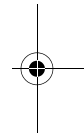
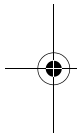

Error messages

If you receive an error message, note the message and take the corrective action. The following table lists the error messages in alphabetical order together with the recommended course of action.



Note: To enter the BIOS Setup Utility, press F2 during POST. For more information, see "BIOS Setup Utility" on page 64.

Error Messages	Corrective Action
0200 Failure Fixed Disk	Hard disk error detected. Enter the BIOS Setup Utility and verify the hard disk is detected. If not, contact your dealer or an authorized service center.
0211 Keyboard error	Try using an external keyboard. If the external keyboard works, contact your dealer or an authorized service center.
0212 Keyboard Controller Failed	Keyboard controller test failed. Write down the message and contact your dealer or an authorized service center.
0220 Monitor type does not match CMOS - Run SETUP	Display device mismatch. Enter the BIOS Setup Utility and verify the parameters (try loading the default settings); then save and restart your computer.
0230 Shadow Ram Failed at offset: <i>nnnn</i>	Shadow RAM test failed. Write down the message and contact your dealer or an authorized service center.
0231 System RAM Failed at offset: <i>nnnn</i>	System RAM test failed. Write down the message and contact your dealer or an authorized service center.
0232 Extended RAM Failed at offset: <i>nnnn</i>	Extended RAM test failed. Write down the message and contact your dealer or an authorized service center.



Error Messages	Corrective Action
0250 System battery is dead - Replace and run SETUP	CMOS clock battery needs to be replaced. Contact your dealer or an authorized service center.
0251 System CMOS checksum bad - Default configuration used	CMOS has been corrupted or modified incorrectly. Enter the BIOS Setup Utility and verify the parameters; then save and restart your computer. If the problem persists, contact your dealer or an authorized service center.
0260 System timer error	System timer test failed, and the system board needs to be repaired. Write down the message and contact your dealer or an authorized service center.
0270 Real time clock error	Real time clock test failed, and the system board may need to be repaired. Write down the message and contact your dealer or an authorized service center.
0271 Check date and time settings	Date and time are out of range, and was reset. Enter the BIOS Setup Utility and set the correct date and time.
0280 Previous boot incomplete - Default configuration used	Previous boot-up was not completed successfully. Enter the BIOS Setup Utility and verify the parameters (try loading the default settings); then save and restart your computer.
0281 Memory Size found by POST differed from CMOS	Try reinstalling the memory. See "Installing memory" on page 47. If the problem persists, contact your dealer or an authorized service center.
02B0 Diskette drive A error 02B2 Incorrect Drive A type - run SETUP	Floppy drive test failed, and may need to be repaired or replaced. Contact your dealer or an authorized service center.

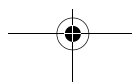
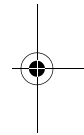
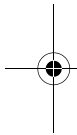

Error Messages	Corrective Action
02D0 System cache error - Cache disabled	Cache memory test failed and was disabled; cache needs to be replaced. Contact your dealer or an authorized service center.
02F4 EISA CMOS not writeable	System unable to write to EISA CMOS. Write down the message and contact your dealer or an authorized service center.
02F5 DMA Test Failed	System unable to write to DMA (Direct Memory Access) registers. Write down the message and contact your dealer or an authorized service center.
02F6 Software NMI Failed	System unable to generate software NMI (Non-Maskable Interrupt). Write down the message and contact your dealer or an authorized service center.
02F7 Fail-Safe Timer NMI Failed	Fail-safe timer takes too long. Write down the message and contact your dealer or an authorized service center.
<i>device</i> Address Conflict	Specific <i>device</i> has an address conflict. Enter the BIOS Setup Utility and verify the parameters (try loading the default settings); then save and restart your computer.
Failing Bits: <i>nnnn</i>	Memory test failed. Write down the message and contact your dealer or an authorized service center.
Invalid System Configuration Data	Error with NVRAM (CMOS) data. Enter the BIOS Setup Utility and verify the parameters (try loading the default settings); then save and restart your computer.



Error Messages	Corrective Action
I/O device IRQ conflict	I/O device has IRQ (Interrupt Request) conflict. Enter the BIOS Setup Utility and verify the parameters (try loading the default settings); then save and restart your computer.
Operating system not found	Operating system cannot be found on the boot device. Enter the BIOS Setup Utility and verify the hard disk, floppy drive, and boot parameters (try loading the default settings); then save and restart your computer. If the problem persists, you may need to recover your hard disk, or reinstall the operating system.
Parity Check 1 <i>nnnn</i>	Parity error found on system bus. Write down the message and contact your dealer or an authorized service center.
Parity Check 2 <i>nnnn</i>	Parity error found on I/O bus. Write down the message and contact your dealer or an authorized service center.

If you still encounter problems after going through the corrective measures, please contact your dealer or an authorized service center for assistance. Some problems may be solved using the BIOS Setup Utility. See "BIOS Setup Utility" on page 64.

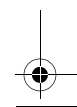
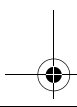
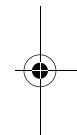
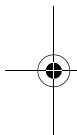

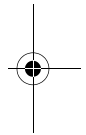
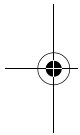
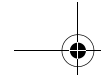

Appendix A Specifications

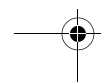
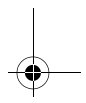
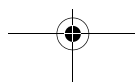
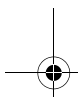

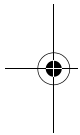
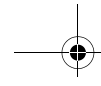

This appendix lists the general specifications of your computer.

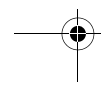
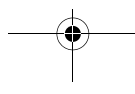
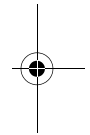

Microprocessor

- Intel® Pentium™ III processor with 256K on-die L2 cache
- or -
- Intel® Celeron™ processor with 128K or 256K on-die L2 cache

Memory

- Onboard 128 MB
- Main memory expandable to 640 MB Synchronous Dynamic Random Access Memory (SDRAM)
- One 1.25-inch, 144-pin industry-standard soDIMM socket (PC-133)
- 512 KB Flash ROM BIOS

Data storage

- One internal floppy drive (3.5", 1.44 MB)
- One E-IDE hard disk (2.5", 9.5mm, UltraDMA-100)
- One internal optical drive

Display and video

- 14.1" Thin-Film Transistor (TFT) liquid-crystal display (LCD) displaying 16.7 million colors at 1024x768 eXtended Graphics Array (XGA) resolution
- or -
- 15.0" TFT LCD displaying 16.7 million colors at 1400x1050 Super eXtended Graphics Array Plus (SXGA+) resolution
- AGP 4X support
- Video memory allocation from main memory (BIOS)
- Simultaneous LCD and CRT display
- S-video (NTSC/PAL) output
- DualView support



Audio

- 16-bit stereo audio (AC'97)
- Two built-in stereo speakers
- Audio DJ playback controls
- Audio ports for speaker/headphone-out and microphone-in devices

Keyboard and pointing device

- 85-/86-key Windows keyboard
- Ergonomically-centered touchpad pointing device

I/O ports

- One type III or two type II/I PC Card slots (PCMCIA, CardBus)
- One RJ-11 modem jack (V.90, 56K)
- One RJ-45 network jack (Ethernet 10/100)
- One DC-in jack
- One parallel port (ECP/EPP)
- One external monitor port
- One keyboard/mouse port (PS/2)
- One speaker/headphone-out jack (3.5mm minijack)
- One microphone-in jack (3.5mm minijack)
- One video-out jack (S-video)
- Two Universal Serial Bus (USB) ports
- One IEEE 1394 port

Weight and dimensions

- 14.1-inch model
 - 3.11 kg (6.86 lbs)
 - 322(W) x 277(D) x 37.5/43.5(H) mm (12.7" x 10.9" x 1.48"/1.71")
- 15.0-inch model
 - 3.27 kg (7.2 lbs)
 - 322(W) x 277(D) x 38/44(H) mm (12.7" x 10.9" x 1.5"/1.73")

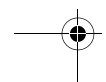
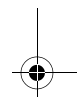
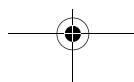
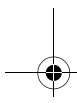
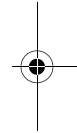
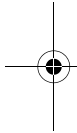

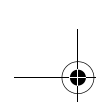

Environment

- Temperature
 - Operating: 5°C ~ 35°C
 - Non-operating: -20°C ~ 65°C
- Humidity (non-condensing)
 - Operating: 20% ~ 80% RH
 - Non-operating: 10% ~ 90% RH
- Altitude
 - Operating: 0 ~ 10,000 ft
 - Non-operating: 0 ~ 40,000 ft

Operating system

- Microsoft Windows

Power

- Battery pack
 - 57-WattHour Li-Ion battery pack
 - 3-4.5 hours charge time
- AC adapter
 - 60-Watt
 - Auto sensing 100~240Vac, 50~60Hz

Options

- 128/256/512 MB SDRAM memory upgrade module
- Additional AC adapter
- Additional battery pack

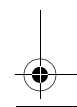
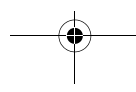
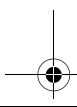
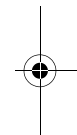
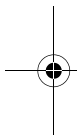

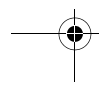
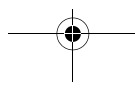
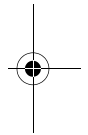
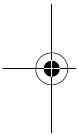
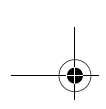

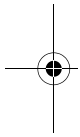
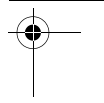
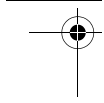
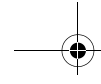

Appendix B Notices

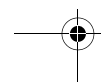
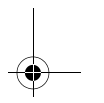
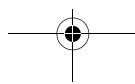
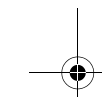
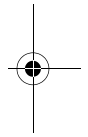

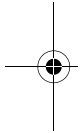
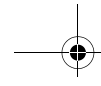

This appendix lists the general notices for your computer.

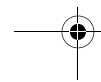
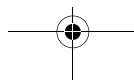
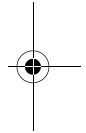



FCC notice

This device has been tested and found to comply with the limits for a Class B digital device pursuant to Part 15 of the FCC Rules. These limits are designed to provide reasonable protection against harmful interference in a residential installation. This device generates, uses, and can radiate radio frequency energy and, if not installed and used in accordance with the instructions, may cause harmful interference to radio communications.

However, there is no guarantee that interference will not occur in a particular installation. If this device does cause harmful interference to radio or television reception, which can be determined by turning the device off and on, the user is encouraged to try to correct the interference by one or more of the following measures:

- Reorient or relocate the receiving antenna
- Increase the separation between the device and receiver
- Connect the device into an outlet on a circuit different from that to which the receiver is connected
- Consult the dealer or an experienced radio/television technician for help

Notice: Shielded cables

All connections to other computing devices must be made using shielded cables to maintain compliance with FCC regulations.

Notice: Peripheral devices

Only peripherals (input/output devices, terminals, printers, etc.) certified to comply with the Class B limits may be attached to this equipment. Operation with non-certified peripherals is likely to result in interference to radio and TV reception.

Caution

Changes or modifications not expressly approved by the manufacturer could void the user's authority, which is granted by the Federal Communications Commission, to operate this computer.

Use conditions

This part complies with Part 15 of the FCC Rules. Operation is subject to the following two conditions: (1) this device may not cause harmful interference, and (2) this device must accept any interference received, including interference that may cause undesired operation.

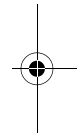
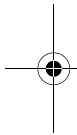

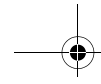

Notice: Canadian users

This Class B digital apparatus meets all requirements of the Canadian Interference-Causing Equipment Regulations.

Remarque à l'intention des utilisateurs canadiens

Cet appareil numérique de la classe B respecte toutes les exigences du Règlement sur le matériel brouilleur du Canada.

Modem notices

FCC

This equipment complies with Part 68 of the FCC rules. Located on the bottom side of the modem is a label that contains, among other information, the FCC Registration Number and Ringer Equivalence Number (REN) for this equipment. Upon request, you must provide this information to your telephone company.

If your telephone equipment causes harm to the telephone network, the telephone company may discontinue your service temporarily. If possible, they will notify you in advance. But, if advance notice is not practical, you will be notified as soon as possible. You will also be informed of your right to file a complaint with the FCC.

Your telephone company may make changes in its facilities, equipment, operations, or procedures that could affect the proper functioning of your equipment. If they do, you will be notified in advance to give you an opportunity to maintain uninterrupted telephone service.

If this equipment should fail to operate properly, disconnect the equipment from the phone line to determine if it is causing the problem. If the problem is with the equipment, discontinue use and contact your dealer or vendor.

CTR 21

This equipment has been approved [Council Decision 98/482/EC - "CTR 21"] for pan-European single terminal connection to the Public Switched Telephone Network (PSTN). However, due to differences between the individual PSTNs provided in different countries, the approval does not, of itself, give an unconditional assurance of successful operation on every PSTN termination point. In the event of problems, you should contact your equipment supplier in the first instance.

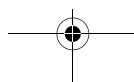
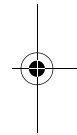
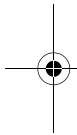



Important safety instructions

Read these instructions carefully. Save these instructions for future reference.

- 1** Follow all warnings and instructions marked on the product.
- 2** Unplug this product from the wall outlet before cleaning. Do not use liquid cleaners or aerosol cleaners. Use a damp cloth for cleaning.
- 3** Do not use this product near water.
- 4** Do not place this product on an unstable cart, stand, or table. The product may fall, causing serious damage to the product.
- 5** Slots and openings in the cabinet and the back or bottom are provided for ventilation; to ensure reliable operation of the product and to protect it from overheating, these openings must not be blocked or covered. The openings should never be blocked by placing the product on a bed, sofa, rug, or other similar surface. This product should never be placed near or over a radiator or heat register, or in a built-in installation unless proper ventilation is provided.
- 6** This product should be operated from the type of power indicated on the marking label. If you are not sure of the type of power available, consult your dealer or local power company.
- 7** Do not allow anything to rest on the power cord. Do not locate this product where persons will walk on the cord.
- 8** If an extension cord is used with this product, make sure that the total ampere rating of the equipment plugged into the extension cord does not exceed the extension cord ampere rating. Also, make sure that the total rating of all products plugged into the wall outlet does not exceed the fuse rating.
- 9** Never push objects of any kind into this product through cabinet slots as they may touch dangerous voltage points or short out parts that could result in a fire or electric shock. Never spill liquid of any kind on the product.
- 10** Do not attempt to service this product yourself, as opening or removing covers may expose you to dangerous voltage points or other risks. Refer all servicing to qualified service personnel.
- 11** Unplug this product from the wall outlet and refer servicing to qualified service personnel under the following conditions:
 - a** When the power cord or plug is damaged or frayed
 - b** If liquid has been spilled into the product
 - c** If the product has been exposed to rain or water
 - d** If the product does not operate normally when the operating instructions are followed. Adjust only those controls that are covered by the operating instructions since improper adjustment of other

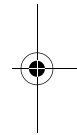
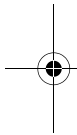



controls may result in damage and will often require extensive work by a qualified technician to restore the product to normal condition.

- e** If the product has been dropped or the cabinet has been damaged
 - f** If the product exhibits a distinct change in performance, indicating a need for service.
- 12** Replace the battery with the same type as the product's battery we recommend. Use of another battery may present a risk of fire or explosion. Refer battery replacement to a qualified serviceman.
- 13** Warning! Batteries may explode if not handled properly. Do not disassemble or dispose of them in fire. Keep them away from children and dispose of used batteries promptly.
- 14** Use only the proper type of power supply cord set (provided in your accessories box) for this unit. It should be a detachable type: UL listed/CSA certified, type SPT-2, rated 7A 125V minimum, VDE approved or its equivalent. Maximum length is 15 feet (4.6 meters).

Laser compliance statement

The CD or DVD drive used with this computer is a laser product. The CD or DVD drive's classification label (shown below) is located on the drive.

CLASS 1 LASER PRODUCT

CAUTION: INVISIBLE LASER RADIATION WHEN OPEN. AVOID EXPOSURE TO BEAM.

APPAREIL A LASER DE CLASSE 1 PRODUIT

LASERATTENTION: RADIATION DU FAISCEAU LASER INVISIBLE EN CAS D'OUVERTURE. EVITER TOUTE EXPOSITION AUX RAYONS.

LUOKAN 1 LASERLAITE LASER KLASSE 1

VORSICHT: UNSICHTBARE LASERSTRAHLUNG, WENN ABDECKUNG GEÖFFNET NICHT DEM STRAHL AUSSETZEN

PRODUCTO LÁSER DE LA CLASE I

ADVERTENCIA: RADIACIÓN LÁSER INVISIBLE AL SER ABIERTO. EVITE EXPONERSE A LOS RAYOS.

ADVARSEL: LASERSTRÅLING VED ÅBNING SE IKKE IND I STRÅLEN.

VARO! LAVATTAESSA OLET ALTTINA LASERSÄTEILYLLE.

WARNING: LASERSTRÅLNING NÅR DENNA DEL ÅR ÖPPNAD ÅLÅ TUIJOTA SÄTEESEENSTIRRA EJ IN I STRÅLEN

WARNING: LASERSTRÅLNING NAR DENNA DEL ÅR ÖPPNADSTIRRA EJ IN I STRÅLEN

ADVARSEL: LASERSTRÅLING NAR DEKSEL ÅPNESSTIRR IKKE INN I STRÅLEN

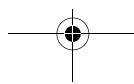
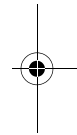
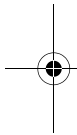

Lithium battery statement

CAUTION

Danger of explosion if battery is incorrectly replaced. Replace only with the same or equivalent type recommended by the manufacturer. Discard used batteries according to the manufacturer's instructions.

ADVARSEL!

Lithiumbatteri - Eksplosionsfare ved fejlagtig håndtering. Udskiftning må kun ske med batteri af samme fabrikat og type. Léver det brugte batteri tilbage til leverandøren.

ADVARSEL

Eksplosjonsfare ved feilaktig skifte av batteri. Benytt samme batteritype eller en tilsvarende type anbefalt av apparatfabrikanten. Brukte batterier kasseres i henhold til fabrikantens instruksjoner.

WARNING

Explosionsfara vid felaktigt batteribyte. Använd samma batterityp eller en ekvivalent typ som rekommenderas av apparattillverkaren. Kassera använt batteri enligt fabrikantens instruktion.

VAROITUS

Päristo voi räjähtää, jos se on virheellisesti asennettu. Vaihda paristo ainoastaan laitevalmistajan suosittelemaan tyyppiin. Hävitä käytetty paristo valmistajan ohjeiden mukaisesti.

VORSICHT!

Explosionsgefahr bei unsachgemäßen Austausch der Batterie Ersatz nur durch denselben oder einem vom Hersteller empfohlenem ähnlichen Typ. Entsorgung gebrauchter Batterien nach Angaben des Herstellers.

Year 2000 compliance statement

The TravelMate α -550 series notebook computer carries the "Hardware NSTL Tested Year 2000 Compliant" logo, which certifies that this model has been tested by NSTL using the YMark2000 test, and has been found to meet NSTL's standards for Year 2000 hardware compliance.



For more details, check the Acer Year 2000 Resource Center Web site (global.acer.com/service/pcy2000.html)

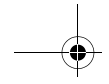

LCD pixel statement

The LCD unit is produced with high-precision manufacturing techniques. Nevertheless, some pixels may occasionally misfire or appear as black or red dots. This has no effect on the recorded image and does not constitute a malfunction.

Macrovision copyright protection notice

This product incorporates copyright protection technology that is protected by method claims of certain U.S. patents and other intellectual property rights owned by Macrovision Corporation and other rights owners. Use of this copyright protection technology must be authorized by Macrovision Corporation, and is intended for home and other limited viewing uses only unless otherwise authorized by Macrovision Corporation. Reverse engineering or disassembly is prohibited.

Apparatus Claims of U.S. Patent Nos. 4,631,603, 4,577,216, 4,819,098, and 4,907,093 licensed for limited viewing uses only.

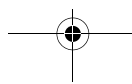
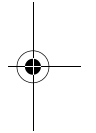
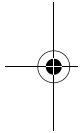

Index

A

- AC adapter
 - caring for iv
- ACPI 36
- audio 26
 - connecting externally 42
 - controlling volume 26
 - troubleshooting 78
- Audio DJ 26

B

- battery bay 8
- battery pack
 - battery-low warning 34
 - caring for v
 - characteristics 31
 - charging 33
 - charging modes 33
 - checking charge level 33
 - installing 32
 - low conditions 35
 - optimizing 33
 - removing 32
 - using the first time 31
- battery release latch 8
- BIOS Setup Utility 64– 73
 - Boot menu 72
 - entering 64
 - Exit menu 73
 - Main menu 65
 - navigating 64
 - Others menu 71
 - Security menu 68
 - System Devices menu 67
- bottom view 8
- brightness
 - hotkeys 18

C

- caps lock 15
 - on indicator 12
- care
 - AC adapter iv
 - battery pack v

- computer iv
- CD
 - troubleshooting 79
- charging
 - checking level 33
 - modes 33
- cleaning
 - computer v
- computer
 - bringing to meetings 54
 - caring for iv
 - cleaning v
 - disconnecting 53
 - features 9
 - moving around 54
 - on indicator 14
 - security 27
 - setting up a home office 56
 - taking home 55
 - traveling internationally 58
 - traveling on local trips 57
 - turning off iii
- connections
 - audio 42
 - IEEE 1394 45
 - keyboard, external 40
 - keypad, external 40
 - monitor 39
 - mouse 40
 - printer 41
 - s-video 39
 - tv 39
 - USB 44
- connectivity options 25
 - Ethernet 25
 - modem 25

D

- date
 - setting in BIOS Utility 66
- diskette drive 24
- display 11
 - hotkeys 18
 - performance 11
 - simultaneous 11
 - troubleshooting 77
- DVD
 - troubleshooting 79

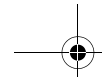

100

E

- emergency eject slot 5
- error messages 81
- Ethernet connection 25

F

- FAQ. See frequently-asked questions
- floppy drive 24
 - troubleshooting 78
- frequently-asked questions 77
- front view 3

G

- guide iii

H

- hard disk 24
 - upgrading 49
- help iii
- hotkeys 18

I

- IEEE 1394
 - connecting 45

K

- keyboard 15
 - connecting externally 40
 - embedded numeric keypad 16
 - hotkeys 18
 - lock keys 15
 - troubleshooting 78
 - Windows keys 17
- keylock 7
- keypad
 - connecting externally 40

L

- launch keys 22
- left view 5

M

- memory
 - compartment 8
 - installing 47– 48
 - upgrade slot 8
 - upgrading 47
- messages
 - error 81
- microphone

- troubleshooting 78

- modem 25
 - setting location 79

- monitor
 - connecting 39

- mouse
 - connecting externally 40

N

- notice
 - DVD copyright protection 98
 - year 2000 compliance 97

- num lock 15
 - on indicator 12

- numeric keypad
 - embedded 16

O

- optical drive 24

- options
 - hard disk upgrade 49
 - memory upgrade 47
 - PC Cards 43
 - spare AC adapter 46
 - spare battery 46

P

- pad lock 15
- palm rest 19
- parallel port
 - setting in BIOS Utility 67

- password 27
 - changing 70
 - removing 70
 - setting 69

- PC Card
 - ejecting 44
 - inserting 43

- ports
 - AC adapter 6
 - external display 7
 - IEEE 1394 7
 - microphone 6
 - modem jack 7
 - network jack 7
 - parallel 7
 - PS/2 6
 - speaker/headphone 6
 - USB 6

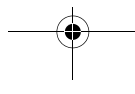
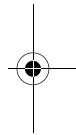
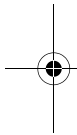

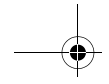

- video-out 7
- power management 36
- printer
 - connecting 41
 - troubleshooting 79
- problems 77
 - audio 78
 - CD 79
 - diskette 78
 - display 77
 - DVD 79
 - floppy drive 78
 - keyboard 78
 - printer 79
 - startup 77

R

- rear view 7
- right view 6

S

- safety
 - CD or DVD 96
 - FCC notice 93
 - general instructions 95
 - lithium battery 97
 - modem notices 94
- scroll lock
 - on indicator 12
- security
 - keylock 7, 27
 - password 27
- service
 - when to call v
- simultaneous display 39
- software

- bundled 61
- speakers
 - troubleshooting 78
- status indicators 12
- status LCD 4, 12
- storage 24
 - floppy drive 24
 - hard disk 24
 - optical drive 24
- s-video
 - connecting 39

T

- time
 - setting in BIOS Utility 66
- touchpad 20
 - using 20– 21
- travel
 - international flights 58
 - local trips 57

U

- USB
 - connecting 44
 - disconnecting 44, 45
- utility
 - BIOS Setup 64– 73

V

- video performance 11
- volume
 - adjusting 26

W

- Windows keys 17

