

Acer Aspire 1300 series

User's guide

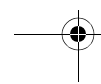

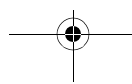
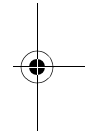
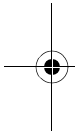

Copyright © 2002
All Rights Reserved

Acer Aspire 1300 Series Notebook Computer User's Guide
Original Issue: May 2002

Changes may be made periodically to the information in this publication without obligation to notify any person of such revision or changes. Such changes will be incorporated in new editions of this manual or supplementary documents and publications. This company makes no representations or warranties, either expressed or implied, with respect to the contents hereof and specifically disclaims the implied warranties of merchantability or fitness for a particular purpose.

Record the model number, serial number, purchase date, and place of purchase information in the space provided below. The serial number and model number are recorded on the label affixed to your computer. All correspondence concerning your unit should include the serial number, model number, and purchase information.

No part of this publication may be reproduced, stored in a retrieval system, or transmitted, in any form or by any means, electronic, mechanical, photocopy, recording, or otherwise, without the prior written permission of Acer Incorporated.

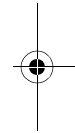
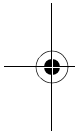

Acer Aspire 1300 series Notebook computer

Model Number : _____

Serial Number: _____

Purchase Date: _____

Place of Purchase: _____

All trademarks and registered trademarks are the properties of their respective companies.

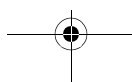

Contents

First things first	vii
Your guides	vii
Basic care and tips for using your computer	vii
Getting familiar with your computer	1
A tour of your computer	3
Front view	3
Left view	5
Right view	6
Rear view	7
Bottom view	8
Features	9
Display	10
Indicators	11
Keyboard	13
Special keys	13
Keyboard ergonomics	17
Touchpad	18
Touchpad basics	18
Launch keys	20
Storage	21
Inserting and ejecting a diskette	21
Ejecting the optical drive tray	21
Emergency ejection of the optical drive tray	22
Connectivity options	23
Ethernet and LAN	23
Fax/data modem	23
Audio	25
Securing your computer	26
Security slot	26
Passwords	26
Operating on battery power	27
Battery pack	29
Battery pack characteristics	29
Installing and removing the battery pack	30
Charging the battery	31
Checking the battery level	31
Optimizing battery life	31
Battery-low warning	31
Power management	33

Peripherals and options	35
External display devices	37
External input devices	38
External keyboard	38
External keypad	38
External pointing device	39
Printer	40
Audio devices	41
Expansion devices	42
PC Card	42
USB devices	44
Miscellaneous options	45
Battery pack	45
AC adapter	45
Key component upgrades	46
Memory upgrade	46
Hard disk upgrade	47
Moving with your computer	49
Disconnecting from the desktop	51
Moving around	52
Preparing the computer	52
What to bring to short meetings	52
What to bring to long meetings	52
Taking the computer home	53
Preparing the computer	53
What to bring with you	53
Special considerations	53
Setting up a home office	54
Traveling with the computer	55
Preparing the computer	55
What to take with you	55
Special considerations	55
Traveling internationally with your computer	56
Preparing the computer	56
What to take with you	56
Special considerations	56
Software	57
System software	59
Launch Manager	59
BIOS Setup Utility	60

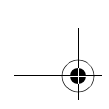

Troubleshooting	65
Frequently asked questions	67
Appendix A Specifications	71
Appendix B Notices	75
Index	83

English

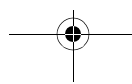
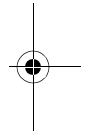
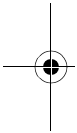



English

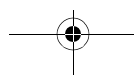
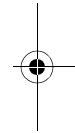
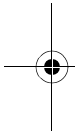

First things first

Your guides

A set of guides is provided to help you set up and use your Aspire computer.:



The *Just for starters...* poster shows you how to set up your computer.



This *User's Guide* provides clear and concise information on using your computer productively. You are advised to read it thoroughly and keep it handy for future reference.

For more information on our products, services, and support, please visit our web site www.global.acer.com.

Basic care and tips for using your computer

Turning your computer on and off

To turn on your computer, open the lid and press the power button above the keyboard.

To turn the power off, you can do any of the following:

- Click on the Start button in Windows, and then select Shut Down on the popup menu.
- Push the power button.

To use this method, you must first click on the Power Management icon in Windows Control Panel, and then check that the power button is set to shut down the computer when pressed. See Windows Help for more information.



Note: if you are unable to shut down the computer in the usual way, press and hold the power switch for more than four seconds. You should then wait at least two seconds before turning the computer on again.

Taking care of your computer

Your computer will serve you well if you take care of it.

- Do not expose the computer to direct sunlight. Do not place it near sources of heat, such as a radiator.
- Do not expose the computer to temperatures below 0°C (32°F), or above 50°C (122°F).
- Do not expose the computer to magnetic fields.
- Do not expose the computer to rain or moisture.
- Do not spill water or any liquid on the computer.
- Do not subject the computer to heavy shock or vibration.
- Do not expose the computer to dust or dirt.
- Do not place objects on top of the computer.
- Do not slam the lid shut. Close the computer gently.
- Do not place the computer on unstable or uneven surfaces.

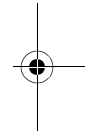
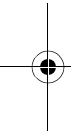

Taking care of your AC adapter

It is important that you look after your AC adapter.

- Do not connect the adapter to any other device.
- Do not step on the power cord or place heavy objects on it. Route the power cord away from areas where people might walk on it or trip over it.
- Do not pull on the power cord when disconnecting from the mains power socket. Grasp and pull the plug instead.
- The total ampere ratings of equipment plugged into a power strip should not exceed the ampere rating for that power strip.

Taking care of your battery pack

It is also important that you look after your computer's battery pack.

- Use the correct battery model for your computer. Do not use other kinds of batteries.
- Turn the power off before removing or replacing the battery.



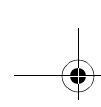

- Do not tamper with the battery. Keep the battery away from children.
- Dispose of batteries according to local regulations. Recycle if possible.

Cleaning and servicing

When cleaning your computer, it is important that you follow these steps:

- 1 Turn off the computer and remove the battery.
- 2 Disconnect the AC adapter.
- 3 Clean with a soft cloth moistened with a little water. Do not use liquid or aerosol cleaners.

Refer to the chapter entitled *Troubleshooting my computer* if any of the following occurs:

- You drop the computer or damage the case.
- You spill liquid on the computer.
- The computer does not operate normally.

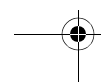
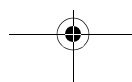
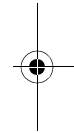
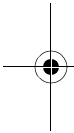

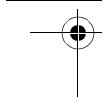
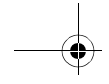

x

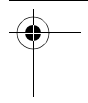

English

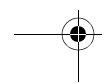
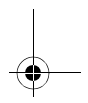
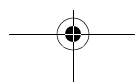
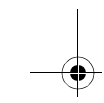
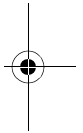
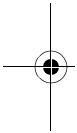

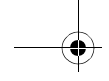

Getting familiar with your computer

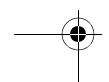
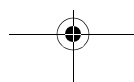
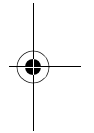
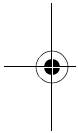

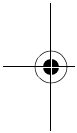

Your Aspire 1300 series notebook computer combines solid performance, versatility, multimedia capabilities and portability with a stylish design. Increase your productivity by working wherever you are. This chapter provides an in-depth "tour" of your computer's features.

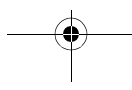
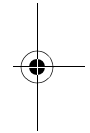

English

A tour of your computer

After setting up your new Aspire notebook computer, as illustrated in the Just for starters... poster, take a few minutes to explore the unit.

Front view

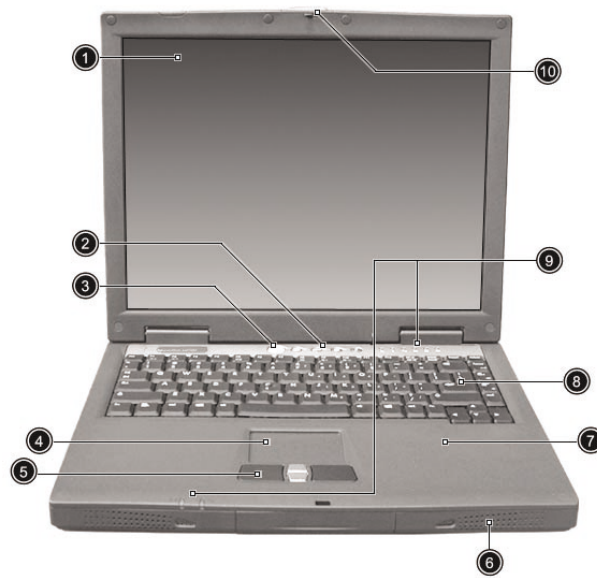

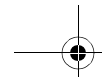

English

#	Item	Description
1	Display	Large liquid crystal display (LCD) provides visual output.
2	Launch keys	4 buttons that can be programmed to start frequently used applications.
3	Power button	Turns the computer on and off.
4	Touchpad	Touch sensitive pad that functions like a computer mouse.
5	Click buttons & scroll key	Right and left buttons that provide the same functions as the buttons on a computer mouse. The scroll key scrolls the contents of a window up and down.
6	Speakers	Left and right speakers deliver stereo audio output.
7	Palm rest	Provides a comfortable platform for your hands when typing on the keyboard.
8	Keyboard	Full-size keyboard for inputting typed data.
9	Status indicators	Light emitting diodes (LED) that show the status of the computer and its components.
10	Latch	Locks and releases the lid.

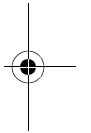
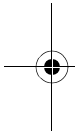

Left view



#	Item	Description
1	Modem jack	Connects the built-in fax/data modem to a phone line.
2	Network jack	Connects the computer to an Ethernet 10/100-based network.
3	Microphone-in jack	Connects an external microphone for audio input.
4	Headphone jack	Connects headphones for audio output.
5	PC card eject button	Press the eject button to remove a PC card from the PC card slot.
6	PC card slot	The slot supports a standard Type II or Type III PC card (PCMCIA or CardBus).
7	Floppy disk drive	Supports a standard 3.5" diskette.
8	Floppy disk eject button	Press the eject button to remove a diskette from the floppy disk drive.

English

Right view



#	Item	Description
1	Optical drive	Depending on your model, the optical drive is one of the following: <ul style="list-style-type: none">• CD-ROM drive for reading CDs.• DVD-ROM drive for reading CDs and DVDs.• DVD/CD-RW combo drive for reading CDs and DVDs, and writing to CD-Rs and CD-RWs.
2	Optical drive emergency eject hole	Used to eject an optical disc when the computer is turned off.
3	Optical drive eject button	Press the eject button to remove a disc from the optical drive.
4	Optical disc read indicator	Light emitting diode (LED) that indicates when an optical disc is being read.

English

Rear view



#	Item	Description
1	Kensington lock slot	For attaching a security connector.
2	DC-in jack	Connects the AC adapter.
3	USB ports	2 ports for connecting USB devices.
4	External display port	Connects an external (VGA) display monitor.
5	Parallel port	Connects a parallel device, such as a printer.
6	Ventilation slots	Enables the computer to stay cool, even after prolonged use.

English

Bottom view



#	Item	Description
1	Ventilation slots	Enables the computer to stay cool, even after prolonged use.
2	Battery	The computer's removable battery.
3	Battery release latch	Slide and hold the latch, and then pull the battery to remove it from the unit.
4	Hard disk bay	Removable cover provides access to the computer's hard drive.
5	Memory compartment	Removable cover provides access to the memory slots for upgrading the computer's memory.

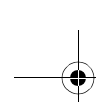

English

Features

Performance

- Mobile AMD Athlon XP1400+, XP1600+, or higher processor.
- VIA ProSavage KN133 chipset.
- 2 memory slots supporting 133MHz SDRAM (PC-133), upgradeable to 1GB.
- 20GB Enhanced-IDE hard disk.
- Microsoft Windows XP operating system.

Multimedia

- Built-in optical drive (CD-ROM, DVD-ROM, or DVD/CD-RW combo drive).
- 14.1" or 15.0" XGA TFT LCD panel.
- Built-in stereo speakers.
- Audio input and output jacks.

Connectivity

- Integrated 10/100Mbps Ethernet connection.
- Built-in 56Kbps fax/data modem.
- 2 universal serial bus (USB) ports.

Human-centric design and ergonomics

- All-in-one design (incorporating hard drive, optical drive and floppy disk drive).
- Rugged, yet extremely portable, construction.
- Stylish appearance.
- Full-size keyboard with 4 programmable launch keys.
- Comfortable palm rest area with well-positioned touchpad.

Expansion

- PC card slot enables a range of add-on options.
- Upgradeable hard disk and memory modules.

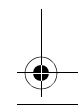
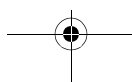
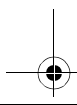
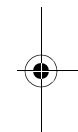
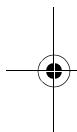



English

Display

The 14.1" or 15.0" display panel provides a large viewing area for maximum efficiency and ease-of-use. The thin-film transistor (TFT) liquid crystal display (LCD) supports extended graphics array (XGA) resolution, enabling 16.7 million colors at 1024 x 768.

Video performance

Your Aspire 1300 series notebook computer features an accelerated graphics port (AGP) video system integrated in the VIA ProSavage KN133 chipset. This provides a robust solution, while enabling high quality video output.

Simultaneous display

Your computer's large display, combined with its multimedia capabilities, makes it ideally suited to delivering presentations.

You can also connect an external monitor or projector, and then choose to use the computer's LCD panel only, the external device only, or the LCD panel and external device simultaneously.

Simultaneous display allows you to manage a presentation on your computer, while your audience watches the monitor or projector screen.

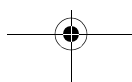
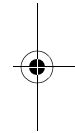
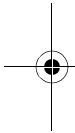







Indicators

Your computer provides an array of six indicators located above the keyboard, in addition to two indicators positioned at the front of the palm rest area. These indicators show the status of the computer and its components.





The six indicators located above the keyboard provide the following status information:

#	Description
1 	Caps Lock active.
2 	Num Lock active. (Note: the keypad lock must be turned on to use the embedded numeric keypad.)
3 	Scroll Lock active.
4 	Floppy disk drive activity.
5 	Hard disk drive activity.
6 	Optical drive activity.



English

The two indicators located at the front of the unit provide the following status information:

#	Description
1 	<p>Battery charge:</p> <p>Green the AC adapter is connected and the battery is fully charged.</p> <p>Amber the AC adapter is connected and the battery is charging.</p> <p>Red the AC adapter is connected and the battery has a fault.</p> <p>Off the AC adapter is not connected, or the battery is not installed.</p>
2 	<p>Power mode:</p> <p>Steady green the computer is on (even if the display is turned off).</p> <p>Flashing green the computer is in standby mode.</p> <p>Off the computer is turned off, or in hibernation mode.</p>

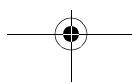
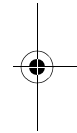
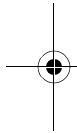

Keyboard

The keyboard features full-size keys with an embedded keypad, separate cursor control keys, two Windows keys, and twelve function keys (hot keys).

English

Special keys

Lock keys

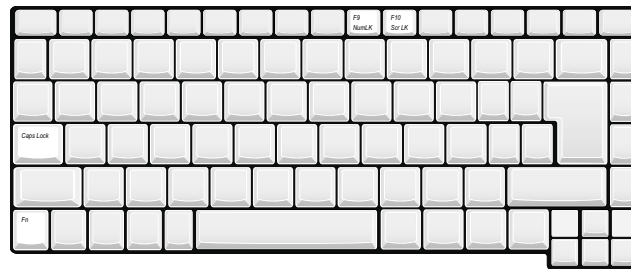

The computer features three lock keys, each with its own status indicator light.

Lock Key	Description
Caps Lock	When Caps Lock is on, all alphabetic characters are typed in uppercase. Toggle on and off by pressing the Caps Lock key on the left side of the keyboard.
Num Lock	When Num Lock is on, the embedded numeric keypad can be used. Toggle on and off by pressing the Fn + F9 keys simultaneously.
Scroll Lock	When Scroll Lock is on, the screen toggles up or down one line at a time when the up and down cursor control keys are pressed. Note: Scroll Lock doesn't work in all applications. Toggle on and off by pressing the Fn + F10 keys simultaneously.



English

Embedded keypad

The embedded keypad functions like a desktop numeric keypad. It is indicated by small blue numbers and characters on the applicable keys.

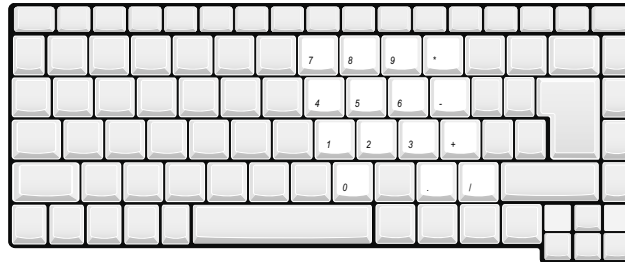

To use the embedded numeric keys, toggle the Num Lk on by pressing the Fn + F9 keys simultaneously.

With the embedded keypad turned on, the following actions are possible:



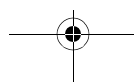
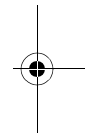
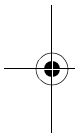



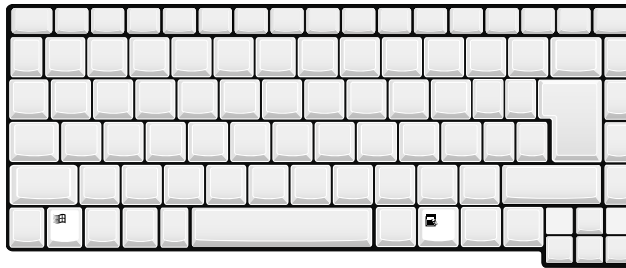

Desired Access	Num lock On	Num lock Off
Number keys on embedded keypad.	Type numbers using embedded keypad in the normal way.	
Cursor control keys on embedded keypad.	Hold down the Shift key while using the cursor keys on the embedded keypad.	Hold Fn key while using cursor-control keys.
Main keyboard keys.	Hold down the Fn key while typing letters using the embedded keypad keys. Simultaneously press the Shift key for capital letters.	Type letters in the normal way.



Windows keys

The keyboard features two keys that provide Windows-specific functions.



Key	Description
Windows key	<p>Pressed alone, this key has the same effect as clicking on the Windows Start button; it launches the Start menu. It can also be used with other keys to provide a variety of functions:</p> <ul style="list-style-type: none">  + Tab activates the next Taskbar button.  + E opens the My Computer window.  + F1 opens Help and Support.  + F opens the Find: All Files dialog box.  + M minimizes all windows. <p>Shift +  + M undoes the minimize all windows ( + M) action.</p> <ul style="list-style-type: none">  + R opens the Run dialog box.
Applications key	<p>This key has the same effect as clicking the right mouse button; it opens the application's context menu.</p>

Hotkeys

Using the Fn key with another key creates a hot key, providing a quick and convenient method for controlling various functions.

To use a hot key, first hold down the Fn key. Next, press the second key in the combination. Finally, release both keys.

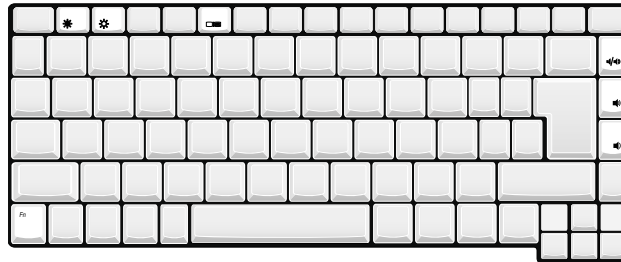

Your computer provides the following hot keys:

HotKey	Function
Fn + F1	Decreases the display panel brightness.
Fn + F2	Increases the display panel brightness.
Fn + F5	Toggles the display setting between (1) the computer's LCD panel, (2) an external display device connected to the external display port, and (3) simultaneous display on the computer's LCD panel and an external display device.
Fn + F9	Toggles Num Lk on and off. (See "Special keys").
Fn + F10	Toggles the keyboard's Scroll Lock on and off. (See "Special keys").
Fn + Home	Toggles the sound on and off. (Mute.)
Fn + Page Up	Increases the sound volume. (Doesn't work for an external keyboard.)
Fn + Page Down	Decreases the sound volume. (Doesn't work for an external keyboard.)

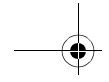

Euro key

Your computer supports the new Euro currency character. First, hold down the Alt Gr key, and then press the Euro key..

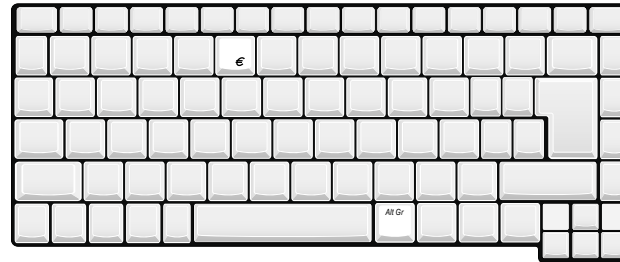

Keyboard ergonomics

The wide palm rest area provides a comfortable platform for your hands when typing on the keyboard. The ergonomic design enables you to adopt a relaxed, yet very efficient, typing style.

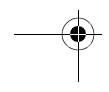
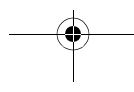
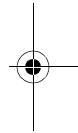
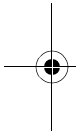

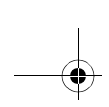

English

Touchpad

The built-in touchpad is a PS/2-compatible pointing device that senses movement on its surface. The cursor responds to your finger movements on the touchpad. In addition, the two click buttons provide the same functionality as a computer mouse, while the scroll key enables easy up and down scrolling in documents and web pages.

The touchpad is located in the middle of the palm rest area, providing maximum comfort and efficiency.



Touchpad basics

Use the touchpad as follows:

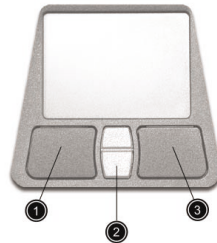

- Slide your finger over the surface of the touchpad to control the movement of the cursor. Tap the touchpad to perform selection and execution functions.
- Press the left (1) and right (3) click buttons to perform selection and execution functions, just as you would use the buttons on a computer mouse.
- Use the scroll key (2) to scroll through long documents and web pages. Press the

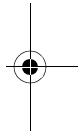
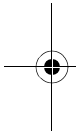

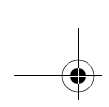

top of the key to scroll up, and the bottom to scroll down.

Function	Left Button	Right Button	Tap
Execute	Click twice quickly.		Tap twice quickly.
Select	Click once.		Tap once.
Drag	Click and hold. Then, slide your finger across the touchpad to drag the cursor over the selection.		Tap twice quickly. On the second tap, slide your finger across the touchpad to drag the cursor over the selection.
Access content menu		Click once.	

English



.....

Note: keep your fingers, as well as the surface of the touchpad, clean and dry. The touchpad is sensitive to your finger movements: the lighter your touch, the better the response. Tapping hard will not increase the touchpad's responsiveness.

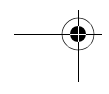
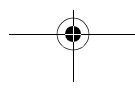
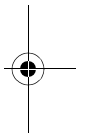
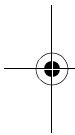

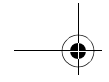

English

Launch keys

Located at the top of the keyboard are four buttons. These buttons are called launch keys. They are designated as key 1, key 2, key 3 and key 4. By default, key 1 is used to launch the email application and key 2 is used to launch the Internet browser. Keys 3 and 4 start the Launch Manager application. All four launch keys can be set by the user. To set the launch keys, run the Acer Launch Manager.

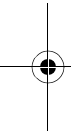

Launch key	Default application
Email	Launches your email application.
Web browser	Launches your Internet browser.
P1	User-programmable
P2	User-programmable

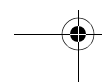
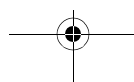
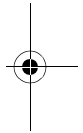

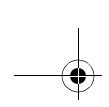

Storage

Your computer's all-in-one design offers a variety of data storage options:

- The high capacity Enhanced-IDE hard disk drive.
The hard drive is upgradeable, enabling you to increase your storage capacity in the future. Consult your dealer if you need to upgrade.
- The floppy disk drive.
The floppy disk drive accepts standard 1.44MB 3.5" diskettes.
- The high speed optical drive.
Depending on your model, you have a CD-ROM, DVD-ROM, or DVD/CD-RW combo drive. The optical drive provides increased storage capacity, as well as offering a host of multimedia possibilities.

See the section entitled, "A tour of your computer," for the locations of these drives.

Inserting and ejecting a diskette

To insert a diskette in the floppy disk drive:

- Push the diskette into the drive. Make sure that the label is on the outer edge, and facing upwards.
- The diskette will click in place, and the floppy disk eject button will pop out.

To remove a diskette from the floppy disk drive:

- Push the floppy disk eject button.
- The diskette will be released, and partially pop out of the drive.
- Pull the diskette from the drive.

Ejecting the optical drive tray

To eject the optical drive tray:

- With the computer turned on, press the optical drive eject button.
- The tray will be released, and partially pop open.
- Gently pull the tray out to its limit.

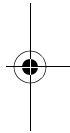
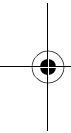

English



To load an optical disc:

- Place a CD or DVD on the open tray. Align the disc's center hole with the tray's spindle.
- Gently push down on the disc until it clicks in place on the spindle.
- Gently push in the tray until it clicks closed.

Emergency ejection of the optical drive tray

If you need to eject the optical drive tray when the computer is turned off, push a straightened paper clip into the optical drive emergency eject hole. The tray will be released, and partially pop open.

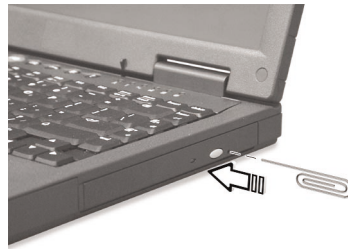

Connectivity options

Your computer has built-in connectivity options, enabling you to hook up to a network or communicate over a phone line.

Ethernet and LAN

The integrated network feature allows you to connect your computer to an Ethernet-based (10/100Mbps) network.

To use the network feature, plug an Ethernet cable into your computer's network jack, and then connect the other end to a network jack or hub on your network.

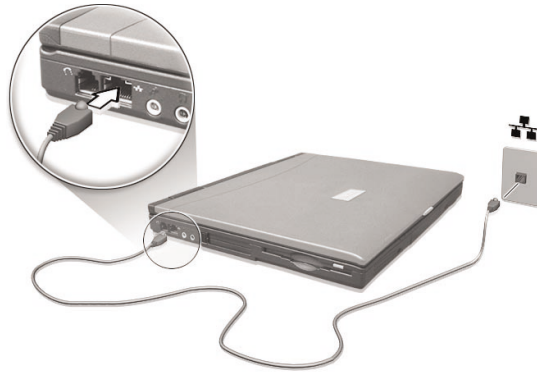

See Windows Help for information on setting up a network connection.

Fax/data modem

Your computer features a built-in fax/data modem, enabling you to communicate over a phone line. This means that you can connect to the Internet via a dialup account with an ISP, log in to your network from a remote location, or send faxes.



.....
Warning: your modem is not compatible with digital phone lines. Plugging the computer into a digital phone system will damage the modem.



English

To use the fax/data modem, plug a phone cable into your computer's modem jack, and then connect the other end to a telephone jack.

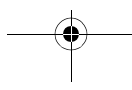
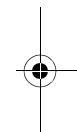
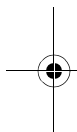
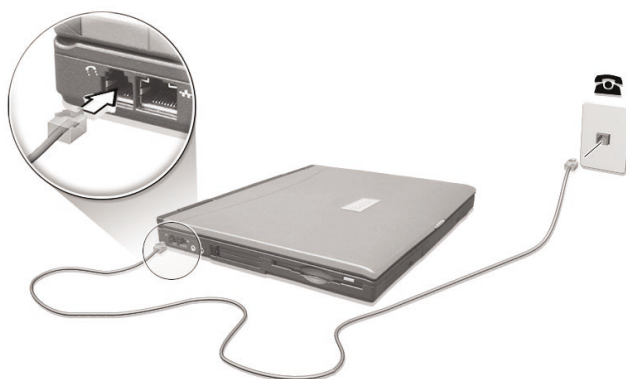

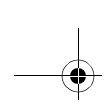

Audio

Your computer includes an integrated stereo audio system. Built-in stereo speakers are located at the front of the unit.

English



Volume is adjusted using software, such as Volume Control in Windows, or any other application that provides a volume adjustment control.

Two audio ports on the left side of the computer enable external devices to be connected. See, "A tour of your computer," for the location of the audio ports. For information on connecting external devices, see "Audio devices," in the section entitled, "Peripherals and options."

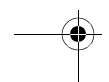
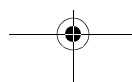
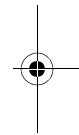
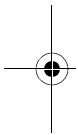



Securing your computer

Your computer features hardware and software security solutions, in the form of a slot for a Kensington lock and a password facility.

Security slot

A slot for a Kensington slot enables you to physically protect your computer from theft. Use this feature as follows:

- Wrap a security lock cable around a heavy or immovable object, such as a drawer handle on a file cabinet, or a table leg.
- Insert the lock into the slot on the computer, turn it 90°, and then lock it in place.

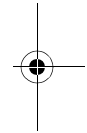
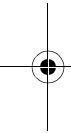

Passwords

You can protect your computer from unauthorized access by setting Windows password protection. The user must enter the password before beginning a Windows session.

- First, open User Accounts in Windows Control Panel and select your account.
- Click Create a Password, and then set your desired password.
- Click Performance and Maintenance, Power Options in Control Panel.
- On the Advanced tab, select the option to prompt for a password when your computer resumes from standby.

To cancel password protection, reset the password with a blank password.



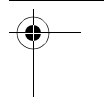
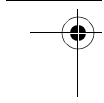
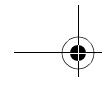

Operating on battery power

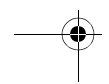
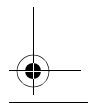
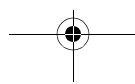
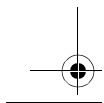
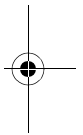
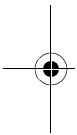

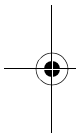
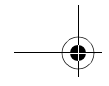

Your Aspire 1300 series notebook computer operates on battery or AC power.

This chapter provides information for operating on battery power, as well as information on how your computer manages and saves power.

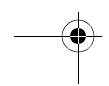
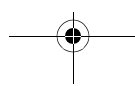
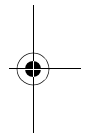

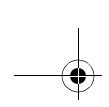

Battery pack

Your computer uses a re-chargeable Ni-Mh or Li-Ion battery pack.

Battery pack characteristics

The battery pack has the following characteristics:

- Employs current battery technology standards.
- Delivers a battery-low warning.

To prolong the life of your Ni-Mh battery pack, fully deplete the battery before recharging. A Li-Ion battery, however, can be recharged at any time.

The battery is recharged whenever you connect the computer to the mains power supply. Your computer supports charge-in-use, enabling you to recharge the battery while you continue to operate the computer. However, recharging with the computer turned off results in a significantly faster charge time.

The battery will come in handy when you travel or during a power failure. It is advisable to have an extra fully charged battery pack available as backup. Contact your dealer for details on ordering a spare battery pack.

Maximizing the battery's life

Like all other batteries, your computer's battery will degrade over time. This means that the battery's performance will diminish with time and use. To maximize your battery's life, you are advised to adhere to the recommendations set out below.

Conditioning a new battery pack

Before you use a battery pack for the first time, there is a "conditioning" process that you should follow:

- 1 Insert the new battery in the computer. Do not turn the computer on.
- 2 Connect the AC adapter and fully charge the battery.
- 3 Disconnect the AC adapter.
- 4 Turn on the computer and operate using battery power.
- 5 Fully deplete the battery until the battery-low warning appears.
- 6 Reconnect the AC adapter and fully charge the battery again.

Follow these steps again until the battery has been charged and discharged three times.

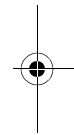
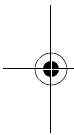



Use this conditioning process for all new batteries, or if a battery hasn't been used for a long time. If the computer is to be stored for more than two weeks, you are advised to remove the battery pack from the unit.



Warning: do not expose battery packs to temperatures below 0°C (32°F) or above 60°C (140°F). Extreme temperatures may adversely affect the battery pack.

By following the battery conditioning process you condition your battery to accept the maximum possible charge. Failure to follow this procedure will prevent you from obtaining the maximum battery charge, and will also shorten the effective lifespan of the battery.

In addition, the useful lifespan of the battery is adversely affected by the following usage patterns:

- Using the computer on constant AC power with the battery inserted. If you want to use constant AC power, you are advised to remove the battery pack after it is fully charged.
- Not discharging and recharging the battery to its extremes, as described above.
- Frequent use: the more you use the battery, the faster it will reach the end of its effective life. A standard computer battery has a lifespan of about 500 charges.

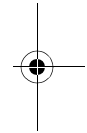
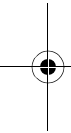

Installing and removing the battery pack



Important! Before removing the battery from the unit, connect the AC adapter if you want to continue using your computer. Otherwise, turn off the computer first.

To install a battery pack:

- 1 Align the battery with the open battery bay; make sure that the end with the contacts will enter first, and that the top surface of the battery is facing up.
- 2 Slide the battery into the battery bay and gently push until the battery locks in place.

To remove a battery pack:

- 1 Slide the battery release latch to release the battery.
- 2 Pull the battery from the battery bay.



Charging the battery

To charge the battery, first make sure that it is correctly installed in the battery bay. Plug the AC adapter into the computer, and connect to a mains power outlet. You can continue to operate your computer on AC power while your battery is charging. However, charging the battery with the computer turned off results in a significantly faster charge time.



.....
Note: you are advised to charge the battery before retiring for the day. Allowing the battery to charge overnight before traveling enables you to start the next day with a fully charged battery.

Checking the battery level

The Windows Power Meter indicates the current battery level. Rest the cursor over the battery/power icon on the taskbar to see the battery's present charge level.

Optimizing battery life

Optimizing battery life helps you get the most out of battery operation, prolonging the charge/recharge cycle and improving recharging efficiency. You are advised to follow the suggestions set out below:

- Purchase an extra battery pack.
- Use AC power whenever possible, reserving your battery for on-the-go use.
- Eject a PC card if it is not being used, as it will continue to draw power.
- Store the battery pack in a cool, dry place. The recommended temperature is 10°C to 30°C. Higher temperatures cause the battery to self-discharge faster.
- Excessive recharging decreases the battery life.
- Look after your AC adapter and battery. See, "Taking care of your AC adapter," and, "Taking care of your battery pack."

Battery-low warning

When using battery power pay attention to the Windows Power Meter.



.....
Warning: connect the AC adapter as soon as possible after the battery-low warning appears. Data will be lost if the battery to become fully depleted and the computer shuts down.



English

When the battery-low warning appears, the recommended course of action depends on your situation:

Situation	Recommended Action
The AC adapter and a power outlet are available.	<ol style="list-style-type: none"> 1. Plug the AC adapter into the computer, and then connect to the mains power supply. 2. Save all necessary files. 3. Resume work. <p>Turn off the computer if you want to recharge the battery rapidly.</p>
An extra fully charged battery pack is available.	<ol style="list-style-type: none"> 1. Save all necessary files. 2. Close all applications. 3. Shut down the operating system to turn off the computer. 4. Replace the battery pack. 5. Turn on the computer and resume work.
The AC adapter or a power outlet is unavailable. You have no spare battery pack.	<ol style="list-style-type: none"> 1. Save all necessary files. 2. Close all applications. 3. Shut down the operating system to turn off the computer.

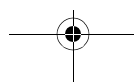
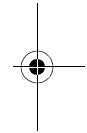
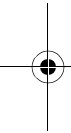

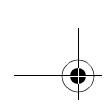

Power management

Your computer features a built-in power management unit that constantly monitors system activity. System activity refers to any activity involving one or more of the following devices: keyboard, touchpad/mouse, floppy disk drive, hard disk drive, optical drive, peripherals connected to the computer, and video memory. If no activity is detected for a period of time (the settings are controlled in Windows Power Management), the computer turns off some, or all, of these devices in order to conserve power.

Your computer employs a power management scheme that supports ACPI (Advanced Configuration and Power Interface), enabling maximum power conservation without compromising system performance. ACPI allows Windows to control the amount of power given to each device attached to the computer. In this way, Windows handles all power-saving chores for your computer. Refer to Windows Help for more information.

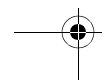
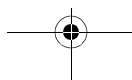
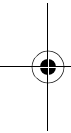



English

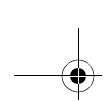

Operating on battery power

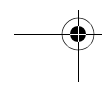
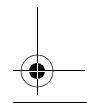
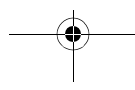
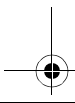
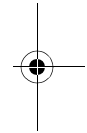
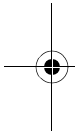

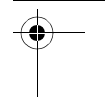
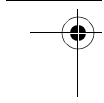

Peripherals and options

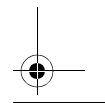
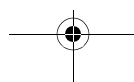
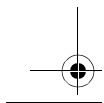
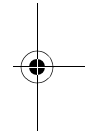
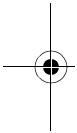



Your Aspire 1300 series notebook computer offers good expansion capabilities.

This chapter provides information on connecting peripherals to expand your system. It also describes how to upgrade key components to enhance system performance and keep your computer in step with the latest technology.

You are advised to consult your dealer for information on peripherals. In addition, make sure that you read the manuals and other documentation provided with new hardware.

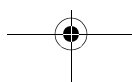
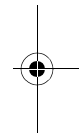
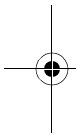

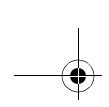

External display devices

You can connect an external (VGA) monitor or projector to your computer's external display port. See the section entitled "Display" for information on using the computer's simultaneous display and multi-display features.

Use the Fn + F5 hot key to toggle the display setting between the computer's LCD panel and the external display device. See "Hot keys" for more information.

English

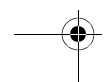
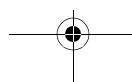
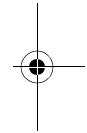
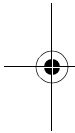



English

External input devices

You can connect a variety of input devices to your computer's USB ports, providing increased functionality and greater ease-of-use. In addition, the USB ports can be used to connect many other peripheral devices, such as digital cameras, printers and scanners. See "Expansion devices" for more information on connecting USB devices.

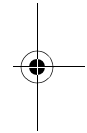
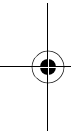

External keyboard

Your computer features a full-size keyboard. However, if you prefer, you can connect an external keyboard to one of your computer's USB ports. This enables you to enjoy the comfort and added features of a full-size desktop system keyboard when inputting typed data on your notebook computer.

External keypad

Your computer features an embedded keypad that, when combined with the Num Lock feature, enables you to easily input typed numeric data. Alternatively, you can connect a 17-key numeric keypad to one of your computer's USB ports. This enables you to enjoy the benefits of a numeric keypad without interfering with your use of the computer's keyboard for typing text.

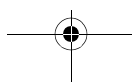

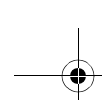

External pointing device

Your computer features a sensitive touchpad pointing device with two click buttons and a scroll key. However, if you prefer to use a conventional mouse or other pointing device, you can connect it to one of your computer's USB ports.

English

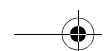
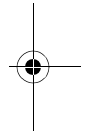
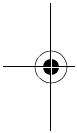

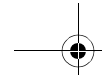

English

Printer

Your computer supports both parallel and USB printers.

Refer to the printer's manual for information on:

- Setting up the hardware.
- Installing the necessary drivers in Windows.
- Operating instructions.

To use a USB printer, simply connect the device to one of your computer's USB ports, and then wait for Windows to find the new hardware.

To connect a parallel printer, first shut down the operating system. Connect the printer to the parallel port, and then restart the computer. Wait for Windows to find the new hardware.

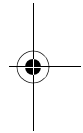
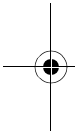

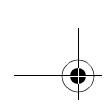

Audio devices

Your computer offers built-in stereo speakers, as well as an internal microphone. See the section entitled "Audio" for more information on these features. However, in addition to the integrated devices, the two audio ports on the left side of the unit enable you to connect external audio input and output devices.

You can plug an external microphone into your computer's microphone-in jack. This offers the convenience of greater freedom of movement, as well as improved audio input quality.

Connect headphones to the headphone jack for private listening and improved audio output quality.

English

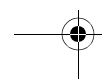
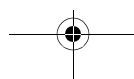
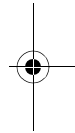
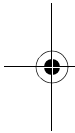

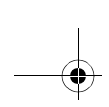

English

Expansion devices

PC Card

Your computer features a PC card slot that supports a standard Type II or Type III PC card (PCMCIA or CardBus). This greatly increases your computer's usability and expandability. A variety of PC cards are available, such as flash memory, SRAM, fax/data modem, LAN, and SCSI cards. Consult your dealer for information on PC card options for your computer.



Note: refer to your card's manual for details on how to install and use the card.

To insert a PC card:

- 1 Align the card with your computer's PC card slot. Make sure that the edge with the connectors is facing the slot, and that the card is the right way up. Many cards are marked with an arrow to help you insert them correctly.
- 2 Slide the card into the slot, and then push gently until the card connects.
- 3 If necessary, connect the card's cable to the jack on the outer edge of the card.
- 4 Windows will automatically detect the card's presence.

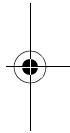
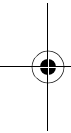

To remove a PC card:

- 1 Close the application that is using the PC card.
- 2 Double click on the PC card icon on the taskbar, and then select the option to safely remove the card. Wait for the message telling you that it is now safe to remove the card.
- 3 Press the PC card eject button to partially eject the card from the slot.
- 4 Pull the card from the slot.

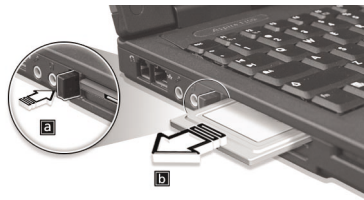

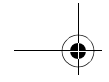

English

USB devices

Your computer features two USB (Universal Serial Bus) ports for connecting a range of USB peripherals. See "External input devices" and "Printer" for information on connecting a USB keyboard, keypad, mouse or printer. Other common USB devices include digital cameras, scanners, and external storage devices.

USB is plug and play, which means that you can connect and start using a USB device without having to restart your computer. You can also disconnect the device at any time.

A further advantage of USB is the ability to use USB hubs. This means that several devices can share a USB port simultaneously.

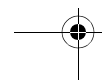
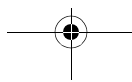
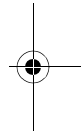
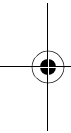

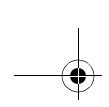

Miscellaneous options

Battery pack

It is a good idea to have a spare battery, especially when you travel with your computer. This greatly increases your productive range when you are on the move.

AC adapter

Having a spare AC adapter allows you to keep one in two different places. For example, you could have one AC adapter at home and another at work. This means that you don't have to carry an AC adapter when traveling between your two base locations.

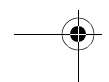
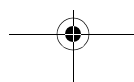
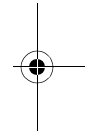
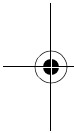

Key component upgrades

Your computer is designed to deliver solid performance. However, in time, you might find that your applications demand even more computing power. For this reason, you are able to upgrade key components.



Note: contact your authorized dealer if you decide to perform a key component upgrade.

Memory upgrade

Your computer features two memory slots that accept soDIMMs (Small Outline Dual Inline Memory Modules). The memory slots support PC-133 SDRAM (Synchronous Dynamic Random Access Memory).

The memory slots are easily accessible, allowing you to upgrade your computer's memory.

To install memory:

- 1 Turn off the computer. Make sure that the AC adapter is disconnected, and then remove the battery pack.
- 2 Turn the computer over to access the memory compartment on the bottom of the unit. Remove the screw from the memory compartment door, and then lift the door off.

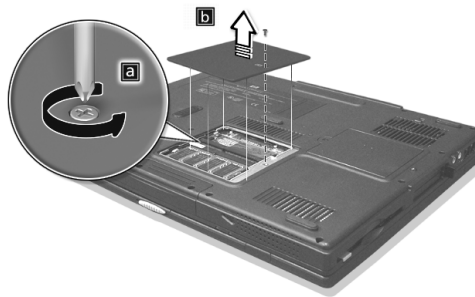

- 3 Insert the memory module diagonally in the slot (a), and then press down gently until it clicks in place (b).

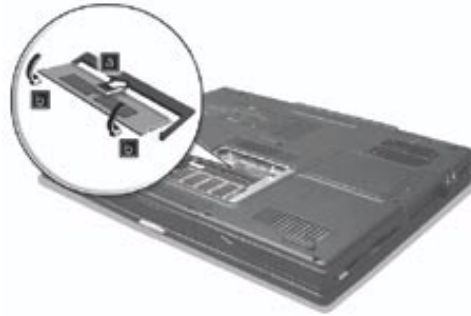

- 4 Replace the memory compartment door, and fasten the screw.
The computer automatically detects the new module and reconfigures the memory.

Hard disk upgrade

It is possible to replace your hard disk with a higher capacity drive when you need more storage space. Your computer uses a 9.5mm 2.5-inch Enhanced-IDE hard disk. Consult your dealer if you need to perform a hard disk upgrade.



English

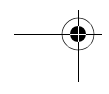
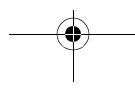
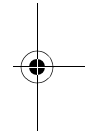
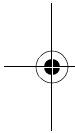
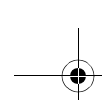

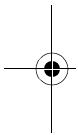
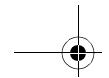

Moving with your computer

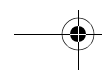
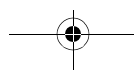
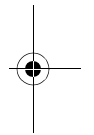

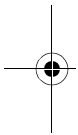
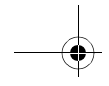

Your Aspire 1300 series notebook computer is ideal for taking with you when you move around. This chapter provides tips on things to consider when traveling with your computer.

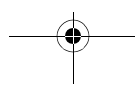
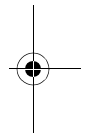

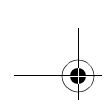

Disconnecting from the desktop

Before moving with your computer, you must turn it off and disconnect all peripherals:

- 1 Save your work and close all applications.
- 2 Shut down Windows to turn off your computer.
- 3 Unplug the AC adapter from the mains outlet, and then disconnect it from the computer.
- 4 Disconnect any external devices, such as a keyboard, mouse, or printer, that are attached to your computer.
- 5 If you are using a security lock cable, disconnect the lock from the computer.
- 6 Pack your computer in a strong, waterproof bag or case.

English

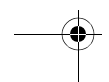
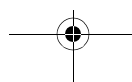
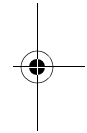
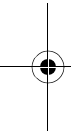



English

Moving around

Sometimes you might need to move your computer a short distance. For example, you might need to move from your office desk to a meeting room. In these situations, you don't have to shut down the operating system.

Preparing the computer

First, disconnect any peripherals that you don't want to take with you. Next close the lid, placing your computer in Standby mode. You can now safely carry it around the building with you.

When you are ready to use your computer again, open the lid and then press the power button to bring it out of Standby mode.

What to bring to short meetings

If your battery is fully charged, you probably won't need to take anything else with you to the meeting.

What to bring to long meetings

For longer meetings, take along the AC adapter. You can use mains power throughout the meeting, or you can run down your battery first, and then connect the AC adapter after receiving the battery-low warning.

If the meeting room does not have an available power outlet, reduce your computer's power consumption by putting it in Standby mode during long periods of inactivity. It is advisable to take along a spare battery if you have one.

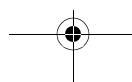
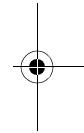
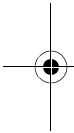

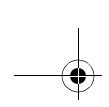

Taking the computer home

When you move between your office and home you will need to prepare your computer for the short trip.

Preparing the computer

After disconnecting your computer from the desktop (see "Disconnecting from the desktop"), prepare the unit as follows:

- 1 Remove all media from the drives. Loaded media can damage the drive heads during transit.
- 2 Pack the computer in a protective case that is padded to guard against knocks. Make sure that the unit cannot slide around inside the case.



Caution: avoid packing items next to the top of the computer, as this could result in damage to the screen.

What to bring with you

If you don't have spare items at home, it is advisable to take along the AC adapter and this User's Guide.

Special considerations

To protect your computer in transit, it is advisable to pay attention to the following:

- Minimize the effect of temperature changes. Keep your computer with you instead of placing it in storage holds.
- Avoid leaving your computer in a hot car.
- Changes in temperature and humidity can cause condensation to form in your computer. Before turning the computer on, allow it to return to room temperature, and then check the screen for signs of condensation. If the temperature change is greater than 10°C (18°F), allow the computer to come to room temperature slowly by placing it in a room with a temperature between the outside and room temperatures.



Setting up a home office

If you frequently work on your computer at home, as well as at work, it may be worthwhile purchasing a second AC adapter. This will allow you to travel lighter, as you can keep an AC adapter in each location.

You might also find it worthwhile keeping a second set of peripherals at home, such as a keyboard, keypad, mouse and printer.

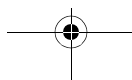
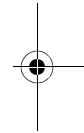
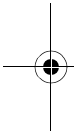

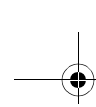

Traveling with the computer

Sometimes you might need to make longer trips with your computer.

Preparing the computer

Prepare the computer as you would for moving between your office and home. It is advisable to make sure that the battery is fully charged. If you are traveling by air, you might be required to turn on the computer during security checks.

What to take with you

It is advisable to take the following items with you:

- AC adapter.
- Spare, fully charged battery packs.
- Additional printer driver files (if you plan to use another printer).
- Phone and network cables (if you plan to use the computer's modem and network connections).

Special considerations

In addition to the considerations for taking your computer home, keep the following in mind:

- Always take your computer as carry-on luggage.
- If possible, have your computer manually inspected at security checks. Although the computer can pass safely through security X-ray machines, you should never expose it to a metal detector.
- If carried separately, avoid exposing floppy disks to hand-held metal detectors.

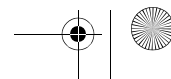
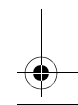
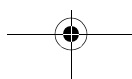
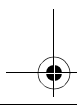
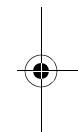
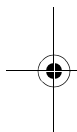



Traveling internationally with your computer

Occasionally you might need to travel between countries with your computer.

Preparing the computer

Prepare the computer as you would for normal travel. Remember to take special precautions for air travel (see "Traveling with your computer").

What to take with you

It is advisable to take the following items with you:

- AC adapter.
- Power cords that are appropriate for the countries you plan to visit.
- Spare, fully charged battery packs.
- Additional printer driver files (if you plan to use another printer).
- Phone and network cables (if you plan to use the computer's modem and network connections). Check that your modem is suitable for the telephone system in the countries you plan to visit. You might have to use a PC card modem in some locations.

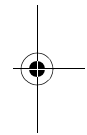
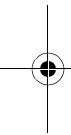

Special considerations

In addition to the considerations for normal travel with your computer, keep the following in mind when traveling internationally:

- Check that your power cord is suitable for the local power supply. If necessary, purchase a power cord that meets local requirements. Avoid using converter kits.
- If you plan to connect over a phone line, check that the computer's modem and your phone cord are suitable for the local phone system. If necessary, purchase a PC card modem that meets local requirements.
- If carried separately, avoid exposing floppy disks to hand-held metal detectors.

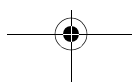

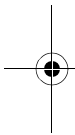

Software

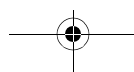
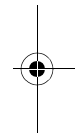

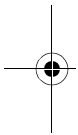
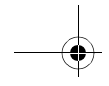

Your Aspire 1300 series notebook computer includes system utilities.
This chapter provides information on the important software that comes with your computer.

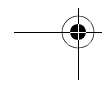
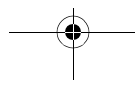
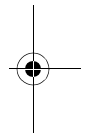

System software

Your computer comes preloaded with the following software:

- Microsoft Windows operating system.
- Hardware BIOS setup utility.
- System utilities, drivers and application software.



Note: to run software applications in Windows, first click on the Start button. Next, select the appropriate folder, and then click on the application icon. To learn about the software and utility, make use of the online help provided by the software.

Launch Manager

Launch Manager allows you to set the four launch keys located above the keyboard. See "Launch keys" on page 20 for the location of the launch keys.

You can access the Launch Manager by clicking on Start, All Programs, and then Launch Manager to start the application.

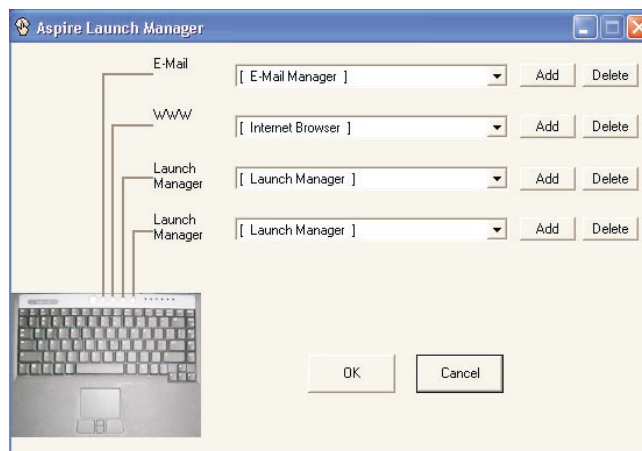

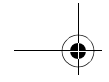

English

BIOS Setup Utility

The BIOS (basic input/output system) contains important information used to configure the hardware and system software settings. Your computer reads the BIOS when it first starts up, before it loads the operating system.

Your computer's BIOS includes a built-in setup utility called Insyde Software SCU (system configuration utility). It can be started shortly after you turn the computer on, by pressing the F2 key during POST .



The BIOS setup utility displays summary information on your computer, its devices, processor and memory.

Your computer is already configured for optimal performance, and so you should not need to run this utility. However, you may need to change the BIOS settings if you encounter configuration problems in the future. Refer to "Troubleshooting" if a problem arises.

Navigating the BIOS Setup Utility

The BIOS setup utility provides two menus: Startup and Exit.

- Use the forward and back cursor control keys to move between the two menus.
- Press the Enter key to launch a menu, and then use the up and down cursor control keys to move between menu items. Alternatively, you can press the appropriate shortcut key (displayed in red) to select a menu or menu item.

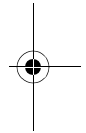
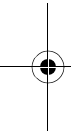

- When you select a menu item, its dialog box is displayed. Information and instructions are displayed at the bottom of the screen.

Startup menu

The Startup menu provides two items: Date and Time, and Boot Device.

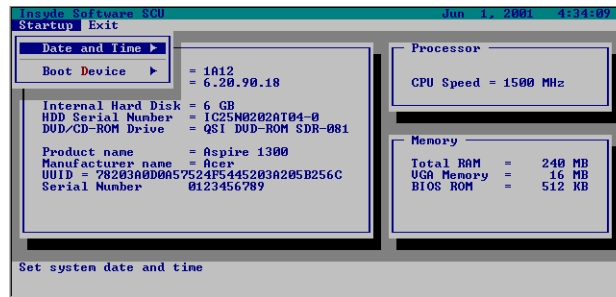

Date and Time

This menu item allows you to change the date and time settings for your computer's built-in clock.

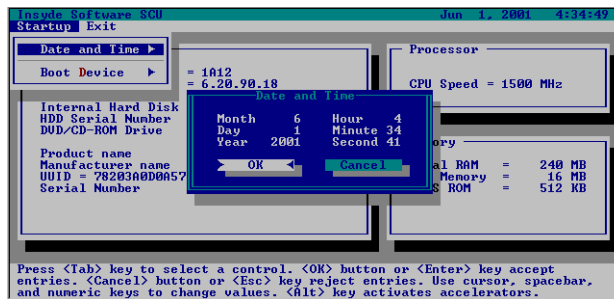

- Turn on your computer, and then press the F2 key to enter the BIOS setup utility.
- Select the startup menu, and the select Date and Time.
- Use the Tab key to scroll through the items until you arrive at a setting that you want to change.
- Use the cursor control keys to increase or decrease the value of a setting. Alternatively, you can type a value.
- Press the Enter key to accept the new settings. Select Cancel or press the Esc key to keep the original settings.



Note: you can change the date and time settings from within Windows by clicking on the Date/Time icon in Control Panel. Alternatively, you can double click the time display on the taskbar.

Boot Device

This menu item allows you to set the order of the boot devices. After reading the BIOS at startup, your computer will search the boot devices for system files. Usually, you will want the computer to boot from the hard disk, as your system files and the Windows operating system are stored there.

If your system files or operating system become corrupted, however, you will need to boot from a floppy disk or CD.

- Turn on your computer, and then press the F2 key to enter the BIOS setup utility.
- Select the startup menu, and then select Boot Device.

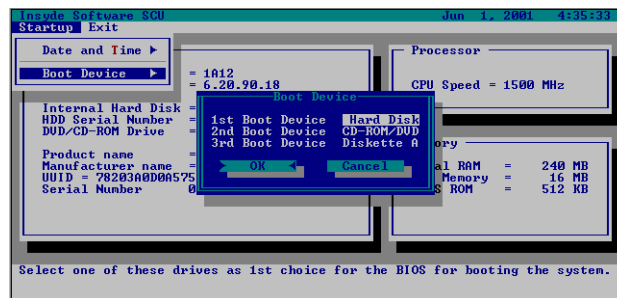

- Use the cursor control keys to change the order of the boot devices. The drive in which you will load a bootable diskette or CD should be set as the first boot device.
- Press the Enter key to accept the new settings. Select Cancel or press the Esc key to keep the original settings.
- Next, load the disk in the appropriate drive, and then exit the BIOS setup utility (see "Save and Reboot" below).
- Your computer will restart and boot from the startup disk.

Exit menu

The Exit menu provides three items: Save and Reboot, Exit (No Save), and Default Settings.

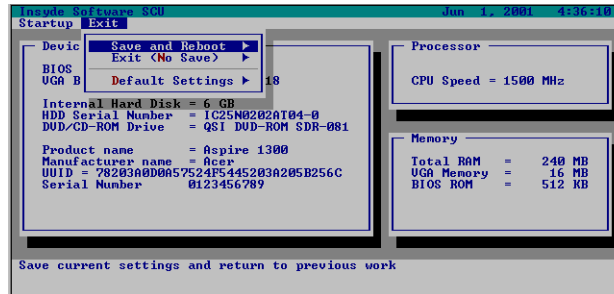

Save and Reboot

This menu item allows you to save the new BIOS settings, before closing the BIOS setup utility and rebooting the computer.

- After making changes to items on the Startup menu, select the Exit menu.
- Select Save and Reboot.



- Press the Enter key to accept the new settings. The BIOS setup utility will close, and the computer will reboot with the new BIOS settings.
- Alternatively, you can select Cancel or press the Esc key to keep the original settings. In this case, the BIOS setup utility will remain open.

Exit (No Save)

This menu item allows you to close the BIOS setup utility without saving any changes.

- Select Exit (No Save) on the Exit menu.



- Press the Enter key to close the BIOS setup utility without saving any changes.
- Alternatively, you can select Cancel or press the Esc key to keep the BIOS setup utility open.

Retype the password in the Confirm new password field.

Default Settings

This menu item allows you to restore the default BIOS settings, before closing the BIOS setup utility and rebooting the computer. The default settings are the configuration that was set in the factory.

- Select Default Settings on the Exit menu.:

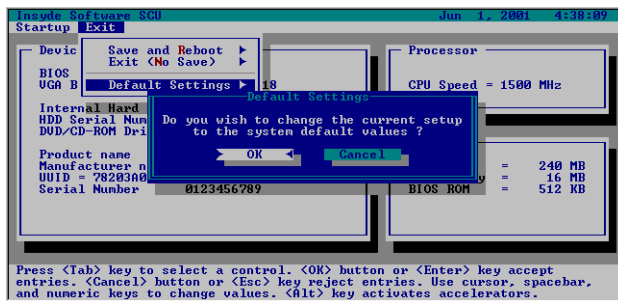

- Press the Enter key to load the default settings. The BIOS setup utility will close, and the computer will reboot with the default BIOS settings.
- Alternatively, you can select Cancel or press the Esc key to keep the original settings. In this case, the BIOS setup utility will remain open.

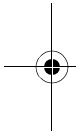
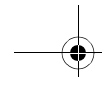

Troubleshooting

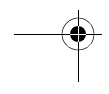
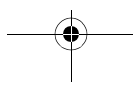
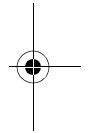

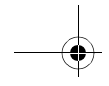

This chapter instructs you on how to deal with common system problems. Please read it before calling a technician.

Solutions to more serious problems may require opening the computer. Do not attempt to open and service the computer by yourself. Contact your dealer or an authorized service center for assistance.

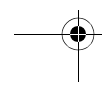
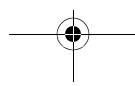
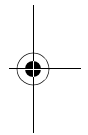
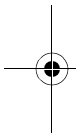



Frequently asked questions

This section suggests solutions to commonly encountered problems.

I press the power switch, but my computer does not start or boot-up.

Look at the Power status indicator:

- If it is not lit, no power is being delivered to the computer. Check the following:
 - If you are running on battery power, the battery may be low and unable to power the computer. Connect the AC adapter to recharge the battery pack.
 - If you are running on mains power, make sure that the AC adapter is properly plugged in to the computer and to the power outlet.
- If it is lit, check the following:
 - Make sure that there is not a non-bootable (non-system) diskette in the floppy disk drive. If so, remove the diskette or replace it with a system diskette, and then press Ctrl-Alt-Del to restart the system.
 - The operating system files may be damaged or missing. Insert the Windows startup disk, and then press Ctrl-Alt-Del to restart the system. Windows will diagnose your system and make necessary fixes.

Nothing appears on the screen.

The computer's power management system automatically blanks the screen to save power. Press any key to turn the display back on.

If pressing a key does not turn the display back on, check the following:

- The brightness level might be too low. Press Fn + F2 hot key to increase the screen brightness level.
- The display device might be set to an external monitor. Press the Fn + F5 hot key to toggle the display setting.
- The system may be in standby mode. Try pressing the power switch to resume.

The image is not full-screen.

Make sure that the resolution is set to a resolution your system supports:

- Right click on your Windows desktop and select Properties to bring up the Display Properties dialog box. Alternatively, click on the Display icon in Control Panel.
- Click on the Settings tab to check the resolution setting. Resolutions lower than the specified resolution result in a display that is less than full-screen.

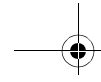

English

There is no audio coming from my computer.

Check the following:

- The volume may be muted. In Windows, look at the volume control icon on the taskbar. If it is crossed-out, click on the icon and deselect the Mute option.
- The volume level may be too low. In Windows, click on the volume control icon on the taskbar, and then use the slider control to increase the volume level.
- If headphones are connected to the headphone jack on the computer, your computer's built-in speakers will be turned off.

My external microphone does not work.

Check the following:

- Make sure that the external microphone is properly plugged into the microphone-in jack on the computer.
- Make sure that the volume is not muted or set too low (see the problem, "There is no audio coming from my computer").

I can't eject the optical drive tray with my computer turned off.

The computer needs to be turned on for the optical drive eject button to function. If you need to eject the optical drive tray when the computer is turned off, push a straightened paper clip into the optical drive emergency eject hole. See "Emergency ejection of the optical drive tray" for more information.

The keyboard does not respond.

Try attaching an external USB keyboard to one of your computer's USB ports. If it works, the internal keyboard might have become disconnected. Contact your dealer or an authorized service center.

The floppy disk drive cannot read a diskette.

Check the following:

- Make sure that the diskette is properly inserted in the floppy disk drive.
- Make sure that the diskette is formatted.
- Try to read a second diskette. If this works, then the first diskette might have a problem.
- If the diskette is not the cause of the problem, then the drive head might be dirty. Clean it using a drive head cleaning kit.

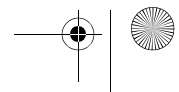
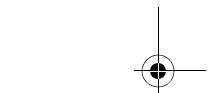
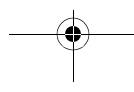
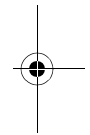
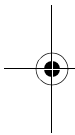

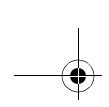

The optical drive cannot read a disc.

Check the following:

- Make sure that the disc is supported by the drive. If your computer has a CD-ROM drive, it can read CDs but cannot read DVDs. If your computer has a DVD drive, it can read CDs and DVDs.
- When placing a disc in the drive tray, make sure that it is secure on the spindle of the drive tray.
- Make sure that the disc is free from scratches or smudges. If the disc is dirty, clean it using a disc cleaning kit.
- If the disc is OK, the drive head might be dirty. Clean it using a drive head cleaning kit.

The printer does not work.

Check the following:

- Make sure that the printer is connected to a power outlet and it is turned on.
- Check that the cable is properly connected to the appropriate ports on both the computer and the printer.
- If you are using a printer connected to your computer's parallel port, restart the computer. Windows needs to find the new hardware and install the necessary drivers.

I want to set up my location to use the internal modem.

Follow these steps:

- Click on Start, and then click on Control Panel.
- Double-click on Phone and Modem Options.
- In the Dialing Rules tab, begin setting up your location.

Refer to Windows Help for more information.

When the battery is 95-99% full, it won't charge to 100% capacity.

To preserve the life of the battery, the system only lets you charge the battery when its capacity falls below 95%. It is recommended that you run down the battery, and then fully recharge it.

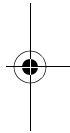
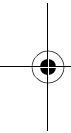



English

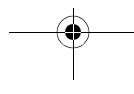
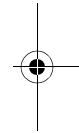
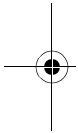
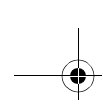



Appendix A Specifications

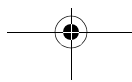
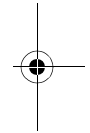
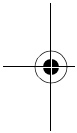

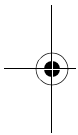
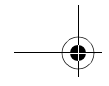

This appendix lists the general specifications of your computer.

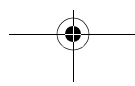
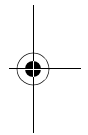

Microprocessor

- Mobile AMD Athlon XP1400+, XP1600+, or higher processor.

Memory

- Standard 128 or 256 MB main memory using Synchronous Dynamic Random Access Memory (SDRAM).
- Two user-upgradeable 144-pin industry-standard soDIMM slots (PC-133).
- Maximum of 1GB.
- 512 KB Flash ROM BIOS.

Data storage

- One internal floppy disk drive (3.5", 1.44 MB).
- One E-IDE hard disk (2.5", 9.5mm, UltraDMA-100).
- One internal optical drive.

Display and video

- 14.1" or 15.0" Thin-Film Transistor (TFT) liquid-crystal display (LCD), displaying 16.7 million colors at 1024 x 768 Extended Graphics Array (XGA) resolution.
- Simultaneous LCD and CRT display.

Audio

- 16-bit stereo audio (AC'97).
- Two built-in stereo speakers.
- Audio ports for microphone-in and headphones.

Keyboard and pointing device

- 88-/90-key Windows keyboard.
- Ergonomically-centered touchpad pointing device.

I/O ports

- One type III or type II PC Card slot (PCMCIA and CardBus).
- One RJ-11 modem jack (V.90, 56K).
- One RJ-45 network jack (Ethernet 10/100).
- One DC-in jack.
- One parallel port (ECP/EPP).
- One external monitor port.
- One microphone-in jack (3.5mm mini jack).



English

- One headphone jack (3.5mm mini jack).
- Two Universal Serial Bus (USB) ports.

Weight and dimensions

- 14.1"-display model:
 - 2.9 kg (6.4 lbs).
 - 320(W) x 262(D) x 34(H) mm
- 15.0"-display model:
 - 3.1kg (6.8 lbs).
 - 330(W) x 267(D) x 35(H) mm

Environment

- Temperature:
 - Operating: 5°C ~ 35°C.
 - Non-operating: -20°C ~ 65°C.
- Humidity (non-condensing):
 - Operating: 20% ~ 80% RH.
 - Non-operating: 10% ~ 90% RH.

Operating system

- Microsoft Windows XP.

Power

- 38.4W 8-cell Ni-Mh or 57W 8-cell Li-ion smart battery pack.
- 75-Watt AC adapter, auto sensing 100~240Vac, 50~60Hz.

Options

- 256/512 MB SDRAM memory upgrade module.
- Additional AC adapter.
- Additional battery pack.

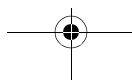
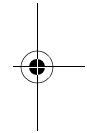
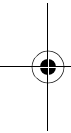

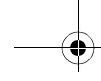

Appendix B

Notices

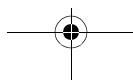
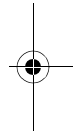
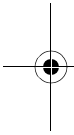

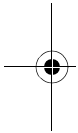
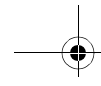

This appendix lists the general notices for your computer.

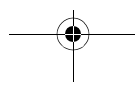
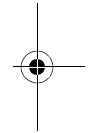

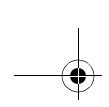

FCC notice

This device has been tested and found to comply with the limits for a Class B digital device pursuant to Part 15 of the FCC Rules. These limits are designed to provide reasonable protection against harmful interference in a residential installation. This device generates, uses, and can radiate radio frequency energy and, if not installed and used in accordance with the instructions, may cause harmful interference to radio communications.

However, there is no guarantee that interference will not occur in a particular installation. If this device does cause harmful interference to radio or television reception, which can be determined by turning the device off and on, the user is encouraged to try to correct the interference by one or more of the following measures:

- Reorient or relocate the receiving antenna.
- Increase the separation between the device and receiver.
- Connect the device into an outlet on a circuit different from that to which the receiver is connected.
- Consult the dealer or an experienced radio/television technician for help.

Notice: Shielded cables

All connections to other computing devices must be made using shielded cables to maintain compliance with FCC regulations.

Notice: Peripheral devices

Only peripherals (input/output devices, terminals, printers, etc.) certified to comply with the Class B limits may be attached to this equipment. Operation with non-certified peripherals is likely to result in interference to radio and TV reception.

Caution

Changes or modifications not expressly approved by the manufacturer could void the user's authority, which is granted by the Federal Communications Commission, to operate this computer.

Use conditions

This part complies with Part 15 of the FCC Rules. Operation is subject to the following two conditions: (1) this device may not cause harmful interference, and (2) this device must accept any interference received, including interference that may cause undesired operation.

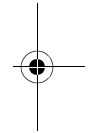
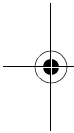



English

Notice: Canadian users

This Class B digital apparatus meets all requirements of the Canadian Interference-Causing Equipment Regulations.

Remarque à l'intention des utilisateurs canadiens

Cet appareil numérique de la classe B respecte toutes les exigences du Règlement sur le matériel brouilleur du Canada.

Modem notices

FCC

This equipment complies with Part 68 of the FCC rules. Located on the bottom side of the modem is a label that contains, among other information, the FCC Registration Number and Ringer Equivalence Number (REN) for this equipment. Upon request, you must provide this information to your telephone company.

If your telephone equipment causes harm to the telephone network, the telephone company may discontinue your service temporarily. If possible, they will notify you in advance. But, if advance notice is not practical, you will be notified as soon as possible. You will also be informed of your right to file a complaint with the FCC.

Your telephone company may make changes in its facilities, equipment, operations, or procedures that could affect the proper functioning of your equipment. If they do, you will be notified in advance to give you an opportunity to maintain uninterrupted telephone service.

If this equipment should fail to operate properly, disconnect the equipment from the phone line to determine if it is causing the problem. If the problem is with the equipment, discontinue use and contact your dealer or vendor.

TBR 21

This equipment has been approved [Council Decision 98/482/EC - "TBR 21"] for pan-European single terminal connection to the Public Switched Telephone Network (PSTN). However, due to differences between the individual PSTNs provided in different countries, the approval does not, of itself, give an unconditional assurance of successful operation on every PSTN termination point. In the event of problems, you should contact your equipment supplier in the first instance.

Telecommunications notices

A-Tick notice

For safety reasons, only connect headsets with a telecommunications compliance label. This includes customer equipment previously labelled permitted or certified.

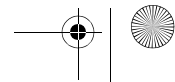
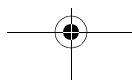
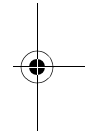
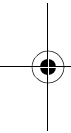

Important safety instructions

Read these instructions carefully. Save them for future reference.

- 1 Follow all warnings and instructions marked on the product.
- 2 Unplug this product from the wall outlet before cleaning. Do not use liquid cleaners or aerosol cleaners. Use a damp cloth for cleaning.
- 3 Do not use this product near water.
- 4 Do not place this product on an unstable cart, stand, or table. The product may fall, causing serious damage to the product.
- 5 Slots and openings are provided for ventilation; to ensure reliable operation of the product and to protect it from overheating. These openings must not be blocked or covered. The openings should never be blocked by placing the product on a bed, sofa, rug, or other similar surface. This product should never be placed near or over a radiator or heat register, or in a built-in installation unless proper ventilation is provided.
- 6 This product should be operated from the type of power indicated on the marking label. If you are not sure of the type of power available, consult your dealer or local power company.
- 7 Do not allow anything to rest on the power cord. Do not locate this product where persons will walk on the cord.
- 8 If an extension cord is used with this product, make sure that the total ampere rating of the equipment plugged into the extension cord does not exceed the extension cord ampere rating. Also, make sure that the total rating of all products plugged into the wall outlet does not exceed the fuse rating.
- 9 Never push objects of any kind into this product through cabinet slots as they may touch dangerous voltage points or short out parts that could result in a fire or electric shock. Never spill liquid of any kind on the product.
- 10 Do not attempt to service this product yourself, as opening or removing covers may expose you to dangerous voltage points or other risks. Refer all servicing to qualified service personnel.
- 11 Unplug this product from the wall outlet and refer servicing to qualified service personnel under the following conditions:
 - a When the power cord or plug is damaged or frayed.
 - b If liquid has been spilled into the product.
 - c If the product has been exposed to rain or water.
 - d If the product does not operate normally when the operating instructions are followed. Adjust only those controls that are covered by the operating instructions since improper adjustment of other controls may result in damage and will often require extensive work by a qualified technician to restore the product to normal condition.
 - e If the product has been dropped or the case has been damaged.
 - f If the product exhibits a distinct change in performance, indicating a need for service.



English

- 12 Replace the battery with the same type as the product's battery we recommend. Use of another battery may present a risk of fire or explosion.
- 13 Warning! Batteries may explode if not handled properly. Do not disassemble or dispose of them in fire. Keep them away from children and dispose of used batteries promptly.
- 14 Use only the proper type of power supply cord set (provided in your accessories box) for this unit. It should be a detachable type: UL listed/CSA certified, type SPT-2, rated 7A 125V minimum, VDE approved or its equivalent. Maximum length is 15 feet (4.6 meters).

Laser compliance statement

The CD or DVD drive used with this computer is a laser product. The CD or DVD drive's classification label (shown below) is located on the drive.

CLASS 1 LASER PRODUCT

CAUTION: INVISIBLE LASER RADIATION WHEN OPEN. AVOID EXPOSURE TO BEAM.

APPAREIL A LASER DE CLASSE 1 PRODUIT

LASERATTENTION: RADIATION DU FAISCEAU LASER INVISIBLE EN CAS D'OUVERTURE.

EVITTER TOUTE EXPOSITION AUX RAYONS.

LUOKAN 1 LASERLAITE LASER KLASSE 1

VORSICHT: UNSICHTBARE LASERSTRAHLUNG, WENN ABDECKUNG GEÖFFNET NICHT DEM STRAHL AUSSETZEN

PRODUCTO LÁSER DE LA CLASE I

ADVERTENCIA: RADIACIÓN LÁSER INVISIBLE AL SER ABIERTO. EVITE EXPONERSE A LOS RAYOS.

ADVARSEL: LASERSTRÅLING VED ÅBNING SE IKKE IND I STRÅLEN.

VARO! LAVATTAESSA OLET ALLTINA LASERSÄTEILYLLE.

WARNING: LASERSTRÅLNING NÅR DENNA DEL ÅR ÖPPNAD ÅLÅ TUIJOTA SÄTEESEENSTIRRA EJ IN I STRÅLEN

WARNING: LASERSTRÅLNING NAR DENNA DEL ÅR ÖPPNADSTIRRA EJ IN I STRÅLEN

ADVARSEL: LASERSTRÅLING NAR DEKSEL ÅPNESSTIRR IKKE INN I STRÅLEN

Lithium battery statement

CAUTION

Danger of explosion if battery is incorrectly replaced. Replace only with the same or equivalent type recommended by the manufacturer. Discard used batteries according to the manufacturer's instructions.

ADVARSEL!

Lithiumbatteri - Eksplosionsfare ved fejlagtig håndtering. Udskiftning må kun ske med batteri af samme fabrikat og type. Léver det brugte batteri tilbage til leverandøren.

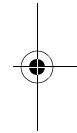
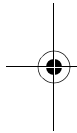

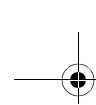

ADVARSEL

Eksplosjonsfare ved feilaktig skifte av batteri. Benytt samme batteritype eller en tilsvarende type anbefalt av apparatfabrikanten. Brukte batterier kasseres i henhold til fabrikantens instruksjoner.

VARNING

Explosionsfara vid felaktigt batteribyte. Använd samma batterityp eller en ekvivalent typ som rekommenderas av apparattillverkaren. Kassera använt batteri enligt fabrikantens instruktion.

VAROITUS

Päristo voi räjähtää, jos se on virheellisesti asennettu. Vaihda paristo ainoastaan laitevalmistajan suosittelemaan tyyppiin. Hävitä käytetty paristo valmistajan ohjeiden mukaisesti.

VORSICHT!

Explosionsgefahr bei unsachgemäßen Austausch der Batterie Ersatz nur durch denselben oder einem vom Hersteller empfohlenem ähnlichen Typ. Entsorgung gebrauchter Batterien nach Angaben des Herstellers.

LCD pixel statement

The LCD unit is produced with high-precision manufacturing techniques. Nevertheless, some pixels may occasionally misfire or appear as black or red dots. This has no effect on the recorded image and does not constitute a malfunction.

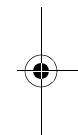
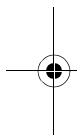



English

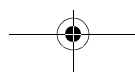
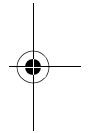
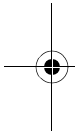
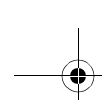

Index

A

ACPI 33
 audio 25
 connecting externally 41
 controlling volume 25
 troubleshooting 68

B

battery bay 8
 battery pack
 battery-low warning 31
 caring for viii
 characteristics 29
 charging 31
 checking charge level 31
 installing 30
 low conditions 32
 maximizing life 29
 optimizing 31
 removing 30, 31
 using the first time 29
 battery release latch 8
 BIOS Setup Utility 60–64
 Advanced menu 63
 entering 60
 navigating 60
 setup menu 61
 boot device
 setting in BIOS Utility 62
 brightness
 hotkeys 16

C

caps lock 13
 on indicator 11
 care
 battery pack viii
 computer viii
 CD
 troubleshooting 69
 charging
 checking level 31
 cleaning
 computer ix

computer

bringing to meetings 52
 caring for viii
 cleaning ix
 disconnecting 51
 features 9
 moving around 52
 security 26
 setting up a home office 54
 taking home 53
 traveling internationally 56
 traveling on local trips 55
 turning off vii

connections

audio 41
 external display devices 37
 external input devices 38
 keyboard, external 38
 keypad, external 38
 mouse 39
 printer 40
 USB 44

connectivity options 23
 Ethernet 23

D

date
 setting in BIOS Utility 61
 diskette drive 21
 display 10
 hotkeys 16
 performance 10
 simultaneous 10
 troubleshooting 67
 DVD
 troubleshooting 69

E

Ethernet connection 23

F

FAQ. See frequently-asked questions
 floppy drive 21
 troubleshooting 68
 frequently-asked questions 67
 front view 3

G

guide vii

84

H

hard disk 21
 upgrading 47
 help vii
 hotkeys 16

K

keyboard 13
 connecting externally 38
 embedded numeric keypad 14
 hotkeys 16
 lock keys 13
 troubleshooting 68
 Windows keys 15
 keypad
 connecting externally 38

L

launch keys 20
 left view 5

M

memory
 compartment 8
 installing 46– 47
 upgrade slot 8
 upgrading 46
 microphone
 troubleshooting 68
 modem
 setting location 69
 mouse
 connecting externally 39
 mute
 hotkeys 16

N

notice
 DVD copyright protection 81
 num lock 13
 on indicator 11
 numeric keypad
 embedded 14

O

optical drive 21
 options
 hard disk upgrade 47
 memory upgrade 46

PC Cards 42
 spare AC adapter 45
 spare battery 45

P

palm rest 17
 password 26
 PC Card
 inserting 42
 removing 43
 ports
 external display 7
 parallel 7
 USB 7
 power management 33
 printer
 connecting 40
 troubleshooting 69
 problems 67
 audio 68
 CD 69
 diskette 68
 display 67
 DVD 69
 floppy drive 68
 keyboard 68
 printer 69
 startup 67

R

rear view 7
 right view 6

S

safety
 CD or DVD 80
 FCC notice 77
 general instructions 79
 lithium battery 80
 modem notices 78
 scroll lock
 on indicator 11
 security
 password 26
 slot 26
 service
 when to call ix
 software
 bundled 59

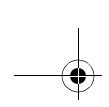

speakers
 troubleshooting 68
status indicators 11
status LCD 11
storage 21
 floppy drive 21
 hard disk 21
 optical drive 21
I
time
 setting in BIOS Utility 61
touchpad 18
 using 18– 19
travel
 international flights 56

local trips 55
U
USB
 connecting 44
utility
 BIOS Setup 60– 64
V
volume
 adjusting 25
 hotkeys 16
W
Windows keys 15

