

# Aspire 3680/5570/5580 Series

## User's Guide

Copyright © 2006. Acer Incorporated.  
All Rights Reserved.

Aspire 3680/5570/5580 Series User's Guide  
Original Issue: 08/2006

Changes may be made periodically to the information in this publication without obligation to notify any person of such revisions or changes. Such changes will be incorporated in new editions of this manual or supplementary documents and publications. This company makes no representations or warranties, either expressed or implied, with respect to the contents hereof and specifically disclaims the implied warranties of merchantability or fitness for a particular purpose.

Record the model number, serial number, purchase date and place of purchase information in the space provided below. The serial number and model number are recorded on the label affixed to your computer. All correspondence concerning your unit should include the serial number, model number and purchase information.

No part of this publication may be reproduced, stored in a retrieval system, or transmitted, in any form or by any means, electronically, mechanically, by photocopy, recording or otherwise, without the prior written permission of Acer Incorporated.

Aspire 3680/5570/5580 Series Notebook PC

Model number: \_\_\_\_\_

Serial number: \_\_\_\_\_

Date of purchase: \_\_\_\_\_

Place of purchase: \_\_\_\_\_

Acer and the Acer logo are registered trademarks of Acer Incorporated. Other companies' product names or trademarks are used herein for identification purposes only and belong to their respective companies.

# Information for your safety and comfort

## Safety instructions

Read these instructions carefully. Keep this document for future reference. Follow all warnings and instructions marked on the product.

### Turning the product off before cleaning

Unplug this product from the wall outlet before cleaning. Do not use liquid cleaners or aerosol cleaners. Use a damp cloth for cleaning.

### Warnings

- Do not use this product near water.
- Do not place this product on an unstable cart, stand or table. If the product falls, it could be seriously damaged.
- Slots and openings are provided for ventilation to ensure reliable operation of the product and to protect it from overheating. These openings must not be blocked or covered. The openings should never be blocked by placing the product on a bed, sofa, rug or other similar surface. This product should never be placed near or over a radiator or heat register, or in a built-in installation unless proper ventilation is provided.
- Never push objects of any kind into this product through cabinet slots as they may touch dangerous voltage points or short-out parts that could result in a fire or electric shock. Never spill liquid of any kind onto or into the product.
- To avoid damage of internal components and to prevent battery leakage, do not place the product on a vibrating surface.

### Using electrical power

- This product should be operated from the type of power indicated on the marking label. If you are not sure of the type of power available, consult your dealer or local power company.
- Do not allow anything to rest on the power cord. Do not locate this product where people will walk on the cord.
- If an extension cord is used with this product, make sure that the total ampere rating of the equipment plugged into the extension cord does not exceed the extension cord ampere rating. Also, make sure that the total rating of all products plugged into the wall outlet does not exceed the fuse rating.
- Do not overload a power outlet, strip or receptacle by plugging in too many devices. The overall system load must not exceed 80% of the branch circuit rating. If power strips are used, the load should not exceed 80% of the power strip's input rating.

- This product's AC adapter is equipped with a three-wire grounded plug. The plug only fits in a grounded power outlet. Make sure the power outlet is properly grounded before inserting the AC adapter plug. Do not insert the plug into a non-grounded power outlet. Contact your electrician for details.



.....

**Warning!** The grounding pin is a safety feature. Using a power outlet that is not properly grounded may result in electric shock and/or injury.



.....

**Note:** The grounding pin also provides good protection from unexpected noise produced by other nearby electrical devices that may interfere with the performance of this product.

- Use the product only with the supplied power supply cord set. If you need to replace the power cord set, make sure that the new power cord meets the following requirements: detachable type, UL listed/CSA certified, type SPT-2, rated 7 A 125 V minimum, VDE approved or its equivalent, 4.6 meters (15 feet) maximum length.

## Product servicing

Do not attempt to service this product yourself, as opening or removing covers may expose you to dangerous voltage points or other risks. Refer all servicing to qualified service personnel.

Unplug this product from the wall outlet and refer servicing to qualified service personnel when:

- the power cord or plug is damaged, cut or frayed
- liquid was spilled into the product
- the product was exposed to rain or water
- the product has been dropped or the case has been damaged
- the product exhibits a distinct change in performance, indicating a need for service
- the product does not operate normally after following the operating instructions



.....

**Note:** Adjust only those controls that are covered by the operating instructions, since improper adjustment of other controls may result in damage and will often require extensive work by a qualified technician to restore the product to normal condition.

## Replacing the battery pack

The notebook uses lithium batteries. Replace the battery with the same type as that which came bundled with your product. Use of another battery may present a risk of fire or explosion.



.....

**Warning! Batteries may explode if not handled properly. Do not disassemble or dispose of them in fire. Keep them away from children. Follow local regulations when disposing of used batteries.**

## Telephone line safety

- Disconnect all telephone lines from the equipment when not in use and/or before servicing.
- To avoid the remote risk of electric shock from lightning, do not connect the telephone line to this equipment during lightning or thunderstorms.



.....

**Warning! For safety reasons, do not use non-compliant parts when adding or changing components. Consult your reseller for purchase options.**

## Disposal instructions

Do not throw this electronic device into the trash when discarding. To minimize pollution and ensure utmost protection of the global environment, please recycle. For more information on the Waste from Electrical and Electronics Equipment (WEEE) regulations, visit <http://global.acer.com/about/sustainability.htm>.



## Mercury advisory

For projectors or electronic products containing an LCD/CRT monitor or display: Lamp(s) inside this product contain mercury and must be recycled or disposed of according to local, state or federal laws. For more information, contact the Electronic Industries Alliance at [www.eiae.org](http://www.eiae.org). For lamp-specific disposal information, check [www.lamprecycle.org](http://www.lamprecycle.org).





ENERGY STAR is a government program (public/private partnership) that gives people the power to protect the environment in a cost effective way and without sacrificing quality or product features. Products that earn the ENERGY STAR prevent greenhouse gas emissions by meeting strict energy efficiency guidelines set by the US Environmental Protection Agency (EPA) and the US Department of Energy (DOE). In the average home, 75% of all electricity used to power home electronics is consumed while the products are turned off. ENERGY STAR qualified home electronic products in the off position use up to 50% less energy than conventional equipment. More information refers to <http://www.energystar.gov> and <http://www.energystar.gov/powermanagement>.

As an ENERGY STAR partner, Acer Inc. has determined that this product meets the ENERGY STAR guidelines for energy efficiency.

This product has been shipped enabled for power management:

- Activate display' Sleep mode within 15 minutes of user inactivity.
- Activate computer's Sleep mode within 30 minutes of user inactivity.
- Wake the computer from Sleep mode by pushing power button.

More power management settings can be done through Acer ePower Management.

## Tips and information for comfortable use

Computer users may complain of eyestrain and headaches after prolonged use. Users are also at risk of physical injury after long hours of working in front of a computer. Long work periods, bad posture, poor work habits, stress, inadequate working conditions, personal health and other factors greatly increase the risk of physical injury.

Incorrect computer usage may lead to carpal tunnel syndrome, tendonitis, tenosynovitis or other musculoskeletal disorders. The following symptoms may appear in the hands, wrists, arms, shoulders, neck or back:

- numbness, or a burning or tingling sensation
- aching, soreness or tenderness
- pain, swelling or throbbing
- stiffness or tightness
- coldness or weakness

If you have these symptoms, or any other recurring or persistent discomfort and/or pain related to computer use, consult a physician immediately and inform your company's health and safety department.

The following section provides tips for more comfortable computer use.

## Finding your comfort zone

Find your comfort zone by adjusting the viewing angle of the monitor, using a footrest, or raising your sitting height to achieve maximum comfort. Observe the following tips:

- refrain from staying too long in one fixed posture
- avoid slouching forward and/or leaning backward
- stand up and walk around regularly to remove the strain on your leg muscles
- take short rests to relax your neck and shoulders
- avoid tensing your muscles or shrugging your shoulders
- install the external display, keyboard and mouse properly and within comfortable reach
- if you view your monitor more than your documents, place the display at the center of your desk to minimize neck strain

## Taking care of your vision

Long viewing hours, wearing incorrect glasses or contact lenses, glare, excessive room lighting, poorly focused screens, very small typefaces and low-contrast displays could stress your eyes. The following sections provide suggestions on how to reduce eyestrain.

### Eyes

- Rest your eyes frequently.
- Give your eyes regular breaks by looking away from the monitor and focusing on a distant point.
- Blink frequently to keep your eyes from drying out.

### Display

- Keep your display clean.
- Keep your head at a higher level than the top edge of the display so your eyes point downward when looking at the middle of the display.
- Adjust the display brightness and/or contrast to a comfortable level for enhanced text readability and graphics clarity.
- Eliminate glare and reflections by:
  - placing your display in such a way that the side faces the window or any light source
  - minimizing room light by using drapes, shades or blinds
  - using a task light
  - changing the display's viewing angle
  - using a glare-reduction filter
  - using a display visor, such as a piece of cardboard extended from the display's top front edge
- Avoid adjusting your display to an awkward viewing angle.
- Avoid looking at bright light sources, such as open windows, for extended periods of time.

## Developing good work habits

Develop the following work habits to make your computer use more relaxing and productive:

- Take short breaks regularly and often.
- Perform some stretching exercises.
- Breathe fresh air as often as possible.
- Exercise regularly and maintain a healthy body.



.....  
**Warning!** We do not recommend using the computer on a couch or bed. If this is unavoidable, work for only short periods, take breaks regularly, and do some stretching exercises.



.....  
**Note:** For more information, please refer to "Regulations and safety notices" on page 90 in the AcerSystem User's Guide.



# First things first

We would like to thank you for making an Acer notebook your choice for meeting your mobile computing needs.

## Your guides

To help you use your Acer notebook, we have designed a set of guides:



First off, the **Just for Starters...** poster helps you get started with setting up your computer.



The printed **User's Guide** introduces you to the basic features and functions of your new computer. For more on how your computer can help you to be more productive, please refer to the **AcerSystem User's Guide**. This guide contains detailed information on such subjects as system utilities, data recovery, expansion options and troubleshooting. In addition it contains warranty information and the general regulations and safety notices for your notebook. It is available in Portable Document Format (PDF) and comes preloaded on your notebook. Follow these steps to access it:

- 1 Click on **Start, All Programs, AcerSystem**.
- 2 Click on **AcerSystem User's Guide**.

**Note:** Viewing the file requires Adobe Reader. If Adobe Reader is not installed on your computer, clicking on **AcerSystem User's Guide** will run the Adobe Reader setup program first. Follow the instructions on the screen to complete the installation. For instructions on how to use Adobe Reader, access the **Help and Support** menu.

---

## Basic care and tips for using your computer

### Turning your computer on and off

To turn on the computer, simply press and release the power button below the LCD screen beside the easy-launch buttons. See "**Front view**" on **page 15** for the location of the power button.

To turn the power off, do any of the following:

- Use the Windows shutdown command  
Click on **Start, Turn Off Computer**, then click on **Turn Off**.
- Use the power button  
You can also shut down the computer by closing the display cover, or by pressing the sleep hotkey **<Fn> + <F4>**.



.....

**Note:** If you cannot power off the computer normally, press and hold the power button for more than four seconds to shut down the computer. If you turn off the computer and want to turn it on again, wait at least two seconds before powering up.

## Taking care of your computer

Your computer will serve you well if you take care of it.

- Do not expose the computer to direct sunlight. Do not place it near sources of heat, such as a radiator.
- Do not expose the computer to temperatures below 0 °C (32 °F) or above 50 °C (122 °F).
- Do not subject the computer to magnetic fields.
- Do not expose the computer to rain or moisture.
- Do not spill water or any liquid on the computer.
- Do not subject the computer to heavy shock or vibration.
- Do not expose the computer to dust or dirt.
- Never place objects on top of the computer.
- Do not slam the computer display when you close it.
- Never place the computer on uneven surfaces.

## Taking care of your AC adapter

Here are some ways to take care of your AC adapter:

- Do not connect the adapter to any other device.
- Do not step on the power cord or place heavy objects on top of it. Carefully route the power cord and any cables away from foot traffic.
- When unplugging the power cord, do not pull on the cord itself but pull on the plug.
- The total ampere ratings of the equipment plugged in should not exceed the ampere rating of the cord if you are using an extension cord. Also, the total current rating of all equipment plugged into a single wall outlet should not exceed the fuse rating.

## Taking care of your battery pack

Here are some ways to take care of your battery pack:

- Use only batteries of the same kind as replacements. Turn the power off before removing or replacing batteries.
- Do not tamper with batteries. Keep them away from children.
- Dispose of used batteries according to local regulations. Recycle if possible.

## Cleaning and servicing

When cleaning the computer, follow these steps:

- 1 Turn off the computer and remove the battery pack.
- 2 Disconnect the AC adapter.
- 3 Use a soft, moist cloth. Do not use liquid or aerosol cleaners.

If either of the following occurs:

- the computer has been dropped or the body has been damaged;
- the computer does not operate normally

please refer to **"Frequently asked questions" on page 53.**



Information for your safety and comfort	iii
Safety instructions	iii
Disposal instructions	v
Tips and information for comfortable use	vi
First things first	ix
Your guides	ix
Basic care and tips for using your computer	ix
Turning your computer on and off	ix
Taking care of your computer	x
Taking care of your AC adapter	x
Taking care of your battery pack	xi
Cleaning and servicing	xi
Acer Empowering Technology	1
Empowering Technology password	1
Acer eNet Management (for selected models)	2
Acer ePower Management	4
Acer ePresentation Management	7
Acer eDataSecurity Management (for selected models)	8
Acer eLock Management (for selected models)	9
Acer eRecovery Management	11
Acer eSettings Management	13
Acer ePerformance Management	14
Your Acer notebook tour	15
Front view	15
Closed front view	16
Left view	17
Right view	18
Rear view	19
Base view	20
Specifications	21
Indicators	27
Easy-launch buttons	28
Touchpad	29
Touchpad basics	29
Using the keyboard	31
Lock keys and embedded numeric keypad	31
Windows keys	32
Hotkeys	32
Special keys	34

# Contents

Ejecting the optical (CD or DVD) drive tray	35
Using a computer security lock	35
<b>Audio</b>	<b>36</b>
Adjusting the volume	36
<b>Using Acer Bluetooth® VoIP Phone</b>	<b>37</b>
1. Getting to know your VoIP phone	37
1.1 Package contents	37
1.2 Layout	37
1.3 LED indicators	38
1.4 Charging the phone	38
2. Connecting the phone to your notebook	39
3. Using the phone	41
<b>Acer OrbiCam</b>	
<b>(for selected models)</b>	<b>42</b>
Launching the Acer OrbiCam	43
Changing the Acer OrbiCam settings	43
Capturing photos/videos	46
Using the Acer OrbiCam as webcam	46
Enabling the Acer VisageON	
(for selected models)	46
<b>Using the system utilities</b>	<b>50</b>
Acer GridVista (dual-display compatible)	50
Launch Manager	51
Norton AntiVirus	52
<b>Frequently asked questions</b>	<b>53</b>
Requesting service	56
International Travelers Warranty (ITW)	56
Before you call	56
<b>Acer Arcade</b>	<b>57</b>
48-button remote control	58
Remote functions	59
Finding and playing content	60
Settings	60
Arcade controls	61
Navigation controls	61
Player controls	61
Virtual keyboard	62
Background mode	62
Cinema	63
Settings	63
Album	64
Editing Pictures	64

Slide Show settings	64
Video	65
Playing a video file	65
Capturing video (TV models only)	65
Snapshot	65
Editing video	66
Music	66
TV (for selected models)	67
Time-shift functionality	67
Recorded TV	68
Scheduling recordings	68
Program guide	68
Find program	68
TV settings	68
Using TeleText functions	69
Make DVDs	70
Authoring CD/DVDs	70
<b>Taking your notebook PC with you</b>	<b>71</b>
Disconnecting from the desktop	71
Moving around	71
Preparing the computer	71
What to bring to meetings	72
Taking the computer home	72
Preparing the computer	72
What to take with you	72
Special considerations	73
Setting up a home office	73
Traveling with the computer	73
Preparing the computer	73
What to take with you	73
Special considerations	74
Traveling internationally with the computer	74
Preparing the computer	74
What to bring with you	74
Special considerations	74
<b>Securing your computer</b>	<b>75</b>
Using a computer security lock	75
Using passwords	75
Entering passwords	76
Setting passwords	76
<b>Expanding through options</b>	<b>77</b>
Connectivity options	77
Fax/data modem	77

Built-in network feature	78
Fast Infrared (FIR)	
(for selected models)	78
Universal Serial Bus (USB)	79
IEEE 1394 port	
(for selected models)	79
PC Card slot	80
Installing memory	80
BIOS utility	81
Boot sequence	81
Enable disk-to-disk recovery	82
Password	82
Using software	83
Playing DVD movies	83
<b>Acer eRecovery Management</b>	<b>83</b>
Create backup	85
Restore from backup	85
Create factory default image CD	86
Re-install bundled software without CD	86
Change password	87
<b>Troubleshooting</b>	<b>88</b>
Troubleshooting tips	88
Error messages	88
<b>Regulations and safety notices</b>	<b>90</b>
FCC notice	90
Modem notices	91
Laser compliance statement	94
LCD pixel statement	94
Macrovision copyright protection notice	94
Radio device regulatory notice	95
General	95
European Union (EU)	95
The FCC RF safety requirement	96
Canada — Low-power license-exempt radio communication devices (RSS-210)	97
Federal Communications Commission	
Declaration of Conformity	98
Declaration of Conformity for CE Marking	99
LCD panel ergonomic specifications	100
<b>Index</b>	<b>104</b>



# Acer Empowering Technology

Acer's innovative Empowering Technology toolbar makes it easy for you to access frequently used functions and manage your new Acer computer. Displayed by default in the upper-right corner of your screen, it features the following handy utilities:

- **Acer eNet Management (for selected models)** hooks up to location-based networks intelligently.
- **Acer ePower Management** extends battery power via versatile usage profiles.
- **Acer ePresentation Management** connects to a projector and adjusts display settings conveniently.
- **Acer eDataSecurity Management (for selected models)** protects data with passwords and advanced encryption algorithms.
- **Acer eLock Management (for selected models)** limits access to external storage media and interfaces.
- **Acer eRecovery Management** backs up and recovers data flexibly, reliably and completely.
- **Acer eSettings Management** accesses system information and adjusts settings easily
- **Acer ePerformance Management** improves system performance by optimizing disk space, memory and registry settings..



For more information, right click on the Empowering Technology toolbar, then select the Help or Tutorial function.

## Empowering Technology password

Before using Acer eLock Management and Acer eRecovery Management, you must initialize the Empowering Technology password. Right-click on the Empowering Technology toolbar and select "**Password Setup**" to do so. If you do not initialize the Empowering Technology password, you will be prompted to do so when running Acer eLock Management or Acer eRecovery Management for the first time.



.....

If you lose your password, there is no method to reset it except by reformatting your notebook or taking your notebook to an Acer Customer Service Center. Be sure to remember or write down your password.

## Acer eNet Management

(for selected models)

Acer eNet Management helps you to quickly and easily connect to both wired and wireless networks in a variety of locations. To access this utility, either click on the **"Acer eNet Management"** icon on your notebook, or start the program from the Start menu. You also have the option to set Acer eNet Management to start automatically when you boot up your PC.

Acer eNet Management automatically detects the best settings for a new location, while offering you the freedom to manually adjust the settings to match your needs.



Acer eNet Management can save network settings for a location to a profile, and automatically switch to the appropriate profile when you move from one location to another. Settings stored include network connection settings (IP and DNS settings, wireless AP details, etc.), as well as default printer settings.

Security and safety concerns mean that Acer eNet Management does not store username and password information.

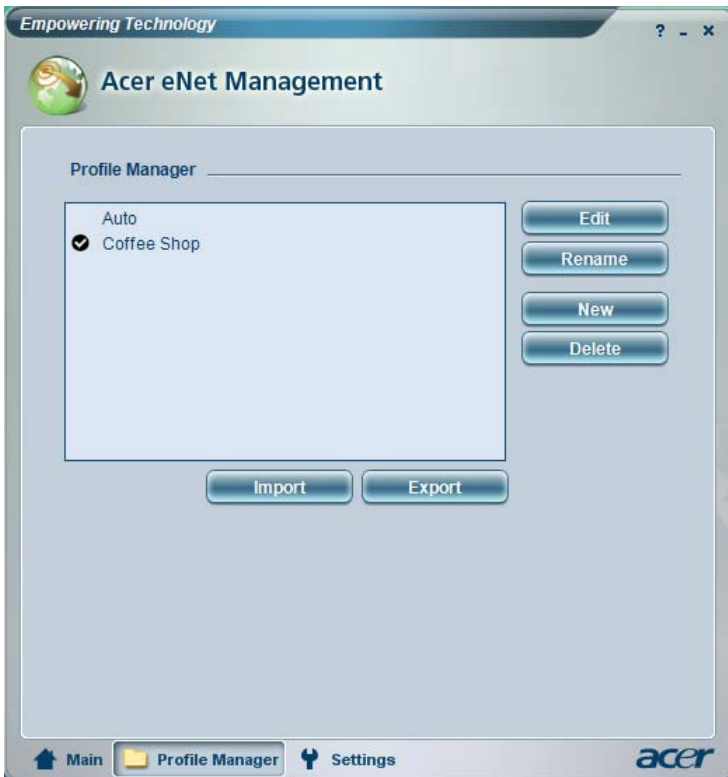

## Acer ePower Management

Acer ePower Management features a straightforward user interface. To launch it, select Acer ePower Management from the Empowering Technology interface.

### AC mode (Adapter mode)

The default setting is "Maximum Performance." You can adjust CPU speed, LCD brightness and other settings, or click on buttons to turn the following functions on/off: Wireless LAN, Bluetooth, CardBus, FireWire(1394), Wired LAN and Optical Device if supported.

### DC mode (Battery mode)

There are four pre-defined profiles — Entertainment, Presentation, Word Processing, and Battery Life. You can also define up to three of your own.

### To create a new power profile:

- 1 Change power settings as desired.
- 2 Click "**Save as ...**" to save to a new power profile.
- 3 Name the newly created profile.
- 4 Select whether this profile is for Adapter or Battery mode, then click **OK**.
- 5 The new profile will appear in the profile list.

## Battery status

For real-time battery life estimates based on current usage, refer to the panel in the upper half of the window.



For additional options, click **"Settings"** to:

- Set alarms.
- Re-load factory defaults.
- Select what actions to be taken when the cover is closed or the power button is pressed.
- Set passwords for accessing the system after Hibernation or Standby.
- View information about Acer ePower Management.

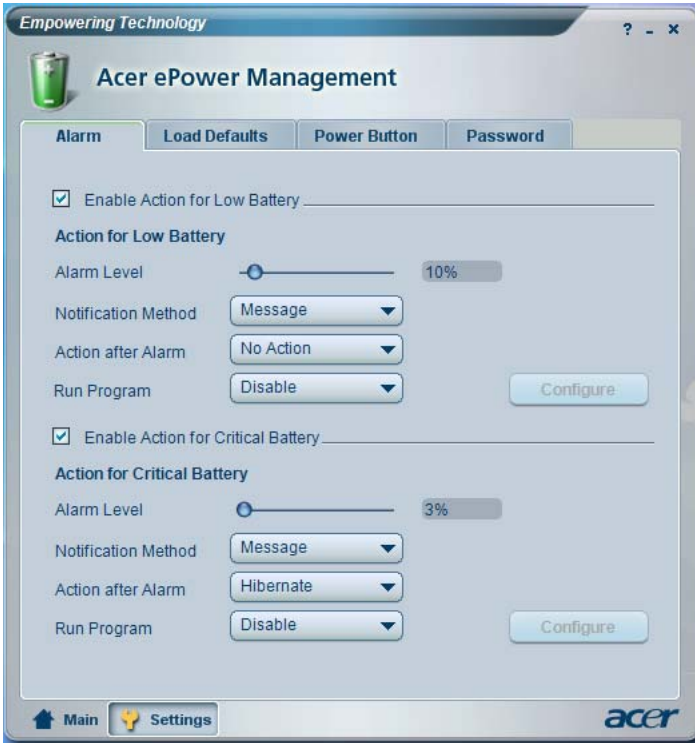

## Acer ePresentation Management

Acer ePresentation Management lets you project your computer's display to an external device or projector using the hot key: Fn + F5. If auto-detection hardware is implemented in the system and the external display supports it, your system display will be automatically switched out when an external display is connected to the system. For projectors and external devices that are not auto-detected, launch Acer ePresentation Management to choose an appropriate display setting.

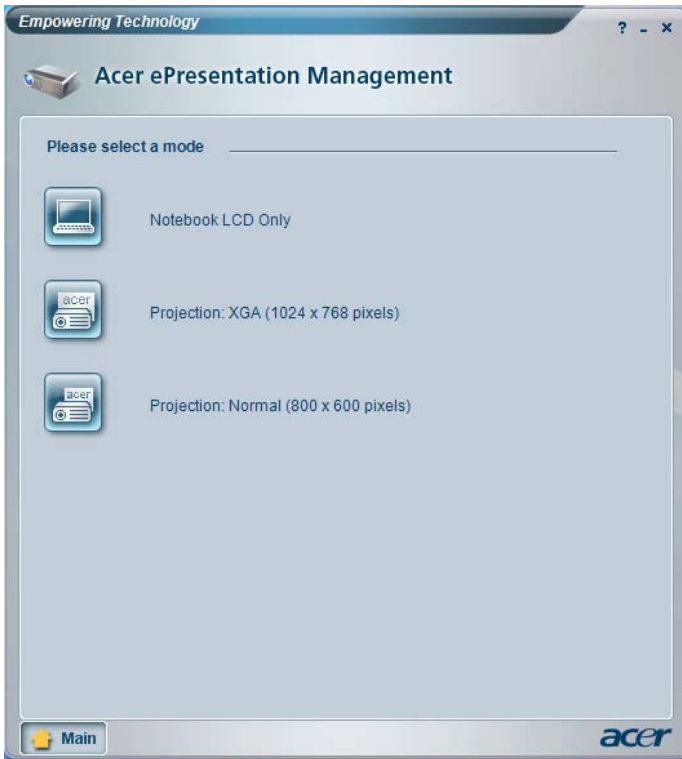

.....

If the restored resolution is not correct after disconnecting a projector, or you need to use an external resolution that is not supported by Acer ePresentation Management, adjust your display settings using Display Properties or the utility provided by the graphics vendor.

# Acer eDataSecurity Management

(for selected models)

Acer eDataSecurity Management is a handy file encryption utility that protects your files from being accessed by unauthorized persons. It is conveniently integrated with Windows Explorer as a shell extension for quick and easy data encryption/decryption and also supports on-the-fly file encryption for MSN Messenger and Microsoft Outlook.

The Acer eDataSecurity Management setup wizard will prompt you for a supervisor password and default encryption. This encryption will be used to encrypt files by default, or you can choose to enter your own file-specific password when encrypting a file.



**Note:** The password used to encrypt a file is the unique key that the system needs to decrypt it. If you lose the password, the supervisor password is the only other key capable of decrypting the file. If you lose both passwords, there will be no way to decrypt your encrypted file! **Be sure to safeguard all related passwords!**



The screenshot shows a dialog box titled "Acer eDataSecurity Management" with a close button (X) in the top right corner. The main heading is "Initialize Supervisor Password". Below this, it explains the purpose of the password: "The Supervisor Password serves two purposes: (1) To grant accesses to the Personal Secure Disk. (2) To provide you a 'last resort' to decrypt any files encrypted before by eDataSecurity." It then instructs the user: "Please record and keep it in a secure place, and never disclose it to anyone." There are two input fields: "Enter Supervisor Password:" and "Enter it again to confirm:", both containing four asterisks (\*\*\*\*). A "Next" button is located at the bottom right, with a mouse cursor pointing to it.



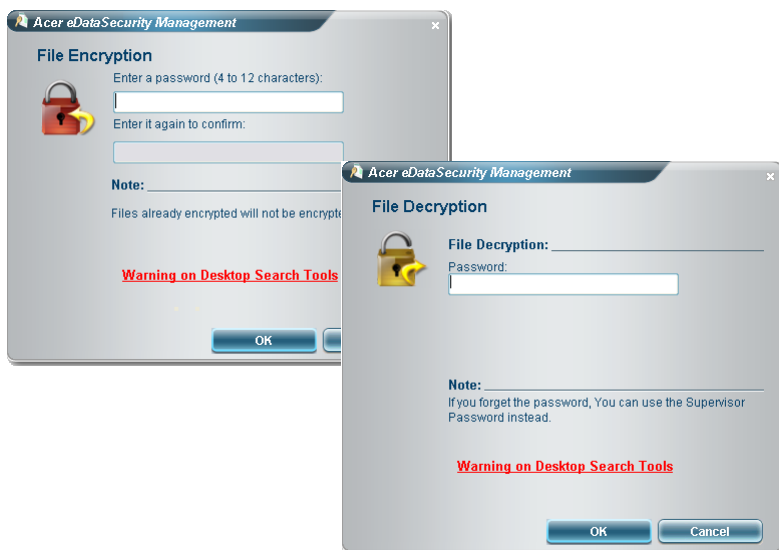

## Acer eLock Management

(for selected models)

Acer eLock Management is a security utility that allows you to lock your removable data, optical and floppy drives to ensure that data can't be stolen while your notebook is unattended.

- Removable data devices — includes USB disk drives, USB pen drives, USB flash drives, USB MP3 drives, USB memory card readers, IEEE 1394 disk drives and any other removable disk drives that can be mounted as a file system when plugged into the system.
- Optical drive devices — includes any kind of CD-ROM or DVD-ROM drives.
- Floppy disk drives — 3.5-inch disks only.
- Interfaces — includes serial port, parallel port, infrared (IR), and Bluetooth.

To activate Acer eLock Management, a password must be set first. Once set, you can apply locks to any of the devices types. Lock(s) will immediately be set without any reboot necessary, and will remain locked after rebooting, until unlocked.



**Note:** If you lose your password, there is no method to reset it except by reformatting your notebook or taking your notebook to an Acer Customer Service Center. Be sure to remember or write down your password.

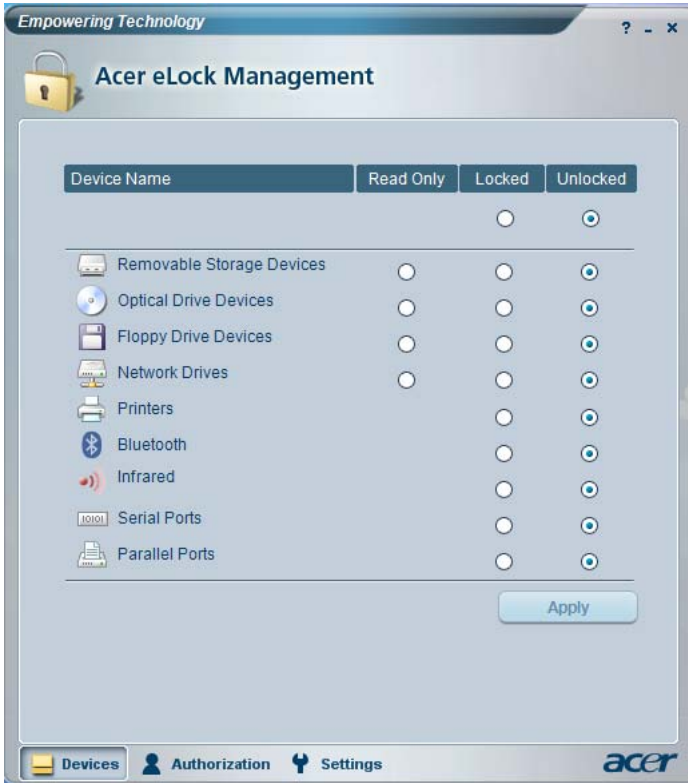

## Acer eRecovery Management

Acer eRecovery Management is a powerful utility that does away with the need for recovery disks provided by the manufacturer. The Acer eRecovery Management utility occupies space in a hidden partition on your system's hard drive. By default, user-created backups are stored on the D:\ drive.

Acer eRecovery Management provides you with:

- Password protection.
- Recovery of applications and drivers.
- Image/data backup:
  - Back up to HDD (set recovery point).
  - Back up to CD/DVD.
- Image/data recovery tools:
  - Recover from a hidden partition (factory defaults).
  - Recover from the HDD (most recent user-defined recovery point).
  - Recover from CD/DVD.

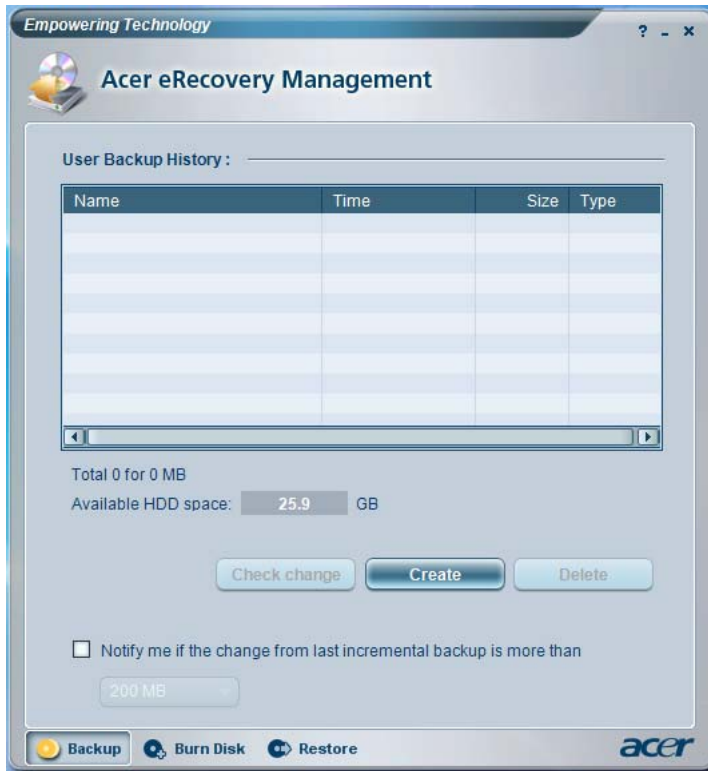

For more information, please refer to "**Acer eRecovery Management**" on page **83** in the **AcerSystem User's Guide**.



**Note:** If your computer did not come with a Recovery CD or System CD, please use Acer eRecovery Management's "System backup to optical disk" feature to burn a backup image to CD or DVD. To ensure the best results when recovering your system using a CD or Acer eRecovery Management, detach all peripherals (except the external Acer ODD, if your computer has one), including your Acer ezDock.

## Acer eSettings Management

Acer eSettings Management allows you to inspect hardware specifications, change BIOS passwords or other Windows settings, and to monitor the system health status.

Acer eSettings Management also:

- Provides a simple graphical user interface for navigation.
- Displays general system status and advanced monitoring for power users on Acer computer.



The screenshot shows the Acer eSettings Management application window. The window title is "Empowering Technology" and the main title is "Acer eSettings Management". The interface includes a navigation bar with tabs for "Summary", "Processor", "Memory", and "MB and BIOS". The "Summary" tab is selected, displaying a table of system information. Below the table is an "Asset tag" field with an "Add Asset Tag" button. At the bottom, there are icons for "System Information", "Boot Options", and "BIOS Passwords", along with the Acer logo.

Item	Value
Manufacturer	Acer, inc.
Product name	xxxxxxxxxx
Operating system	xxxxxxxxxxxxxxxxxxxxxxxxxxxxxxxx
Processor	xxxxxxxxxxxxxxxx
Chipset	xxxxxxxxxxxxxxxx
Wireless LAN card	xxxxxxxxxxxxxxxx
Ethernet card	xxxxxxxxxxxxxxxx
System Memory	xxxxxxxxxx
Video memory	xxxxxxxxxxxxxxxx
Hard drive 1	xxxxxxxxxxxxxxxx
CD/DVD 1	xxxxxxxxxxxxxxxx
Serial port	xxxxxxxxxxxxxx
Infrared	xxxxxxxxxxxxxx
Parallel port	xxxxxxxxxxxxxx
Video	xxxxxxxxxxxxxxxxxxxxxxxxxxxxxxxx

Asset tag:

System Information | Boot Options | BIOS Passwords | acer

## Acer ePerformance Management

Acer ePerformance Management is a system optimization tool that boosts the performance of your Acer computer. It provides an express optimization method to release unused memory and disk space quickly. The user can also enable advanced options for full control over the following options:

- Memory optimization — releases unused memory and check usage.
- Disk optimization — removes unneeded items and files.
- Speed optimization — improves the usability and performance of your Windows XP system.



# Your Acer notebook tour

After setting up your computer as illustrated in the **Just for Starters...** poster, let us show you around your new Acer notebook.

## Front view

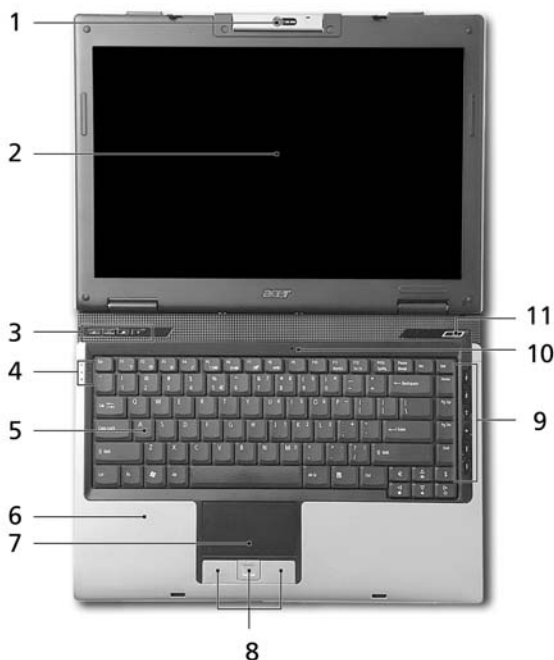





#	Item	Description
1	Built-in camera	1.3 megapixel/310,000 pixel web camera for video communication. (for selected models)
2	Display screen	Also called Liquid-Crystal Display (LCD), displays computer output.
3	Easy-launch buttons	Buttons for launching frequently used programs. See <b>"Easy-launch buttons"</b> on page 28 for more details.
4	Status indicators	Light-Emitting Diodes (LEDs) that light up to show the status of the computer's functions and components.

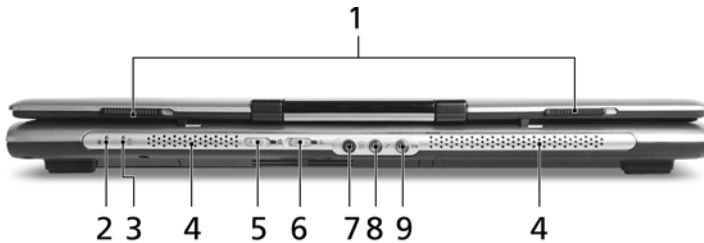

#	Item	Description
5	Keyboard	For entering data into your computer.
6	Palmrest	Comfortable support area for your hands when you use the computer.
7	Touchpad	Touch-sensitive pointing device which functions like a computer mouse.
8	Click buttons (left, center and right)	The left and right buttons function like the left and right mouse buttons; the center button serves as a 4-way scroll button.
9	Arcade/media/volume buttons	For use with Acer Arcade and other media playing programs (for selected models).
10	Microphone	Internal microphone for sound recording.
11	Power button	Turns the computer on and off.

## Closed front view









#	Icon	Item	Description
1		Latch	Locks and releases the lid.
2		Power indicator	Indicates the computer's power status.
3		Battery indicator	Indicates the computer's battery status.
4		Speakers	Left and right speakers deliver stereo audio output.
5		Bluetooth communication switch/indicator	Enable/disables the Bluetooth function. Indicates the status of Bluetooth communication (optional).
6		Wireless communication switch/indicator	Enable/disables the wireless function. Indicates the status of wireless LAN communication (optional).
7		Headphones/speaker/line-out jack with S/PDIF support	Connects to audio line-out devices (e.g., speakers, headphones).



#	Icon	Item	Description
8		Microphone-in jack	Accepts input from external microphones.
9		Line-in jack	Accepts audio line-in devices (e.g., audio CD player, stereo walkman).



## Left view



#	Icon	Item	Description
1		External display (VGA) port	Connects to a display device (e.g., external monitor, LCD projector).
2		Ventilation slots	Enable the computer to stay cool, even after prolonged use.
3		S-video/TV-out (NTSC/PAL) port	Connects to a television or display device with S-video input.
4		USB 2.0 port	Connects to USB 2.0 devices (e.g., USB mouse, USB camera).
5		4-pin IEEE 1394 port	Connects to IEEE 1394 devices. (for selected models)
6		Infrared port	Interfaces with infrared devices (e.g., infrared printer and IR-aware computer). (for selected models)
7		5-in-1 card reader	Accepts Memory Stick (MS), Memory Stick PRO (MS PRO), MultiMediaCard (MMC), Secure Digital (SD) and xD-Picture Card (xD) . <b>Note:</b> Only one card can operate at any given time.
8		PC Card slot	Accepts one Type II PC Card.
9		PC Card slot eject button	Ejects the PC Card from the slot.



## Right view

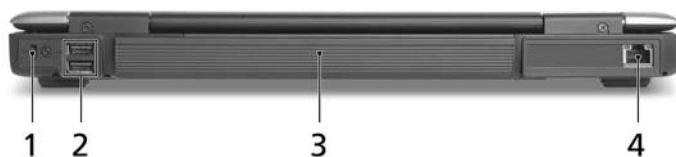

#	Icon	Item	Description
1		Optical drive	Internal optical drive; accepts CDs or DVDs (slot-load or tray-load depending on model).
2		Optical disk access indicator	Lights up when the optical drive is active (location depends on model).
3		Optical drive eject button	Ejects the optical disk from the drive (location depends on model).
4		Emergency eject hole	Ejects the optical drive tray when the computer is turned off (location depends on model).
5		Modem (RJ-11) port	Connects to a phone line.
6		DC-in jack	Connects to an AC adapter.

## Rear view



#	Icon	Item	Description
1		Kensington lock slot	Connects to a Kensington-compatible computer security lock.
2		USB 2.0 ports	Connect to USB 2.0 devices (e.g., USB mouse, USB camera).
3		Battery	Powers the computer.
4		Ethernet (RJ-45) port	Connects to an Ethernet 10/100/1000-based network (for selected models).

## Base view

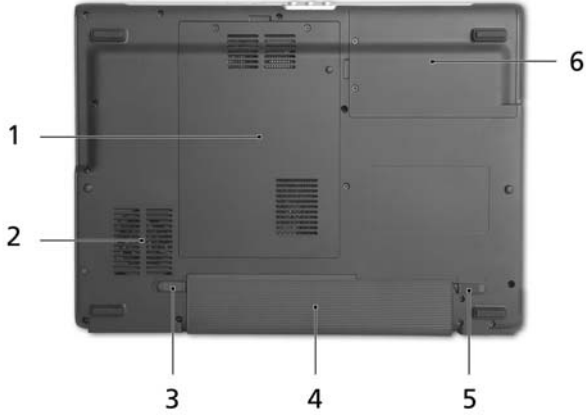

#	Item	Description
1	Memory compartment	Houses the computer's main memory.
2	Cooling fan	Helps keep the computer cool. <b>Note:</b> Do not cover or obstruct the opening of the fan.
3	Battery release latch	Releases the battery for removal.
4	Battery bay	Houses the computer's battery pack.
5	Battery lock	Locks the battery in position.
6	Hard disk bay	Houses the computer's hard disk (secured with screws).

# Specifications

Operating system	<ul style="list-style-type: none"> <li>• Genuine Windows® XP Home Edition (Service Pack 2)</li> <li>• Genuine Windows® XP Starter Edition (for Aspire 3680)</li> <li>• Genuine Windows® XP Media Center Edition 2005 (Rollup 2) (for selected models)</li> </ul>
Platform	<ul style="list-style-type: none"> <li>• Intel® Centrino® Duo mobile technology, featuring:             <ul style="list-style-type: none"> <li>• Intel® Core™ 2 Duo processor T5500/T5600 (2 MB L2 cache, 1.66/1.83 GHz, 667 MHz FSB) and T7200/ T7400/ T7600 (4 MB L2 cache, 2/2.16/2.33 GHz, 667 MHz FSB) (for Aspire 5580)</li> <li>• Intel® Core™ Duo processor T2300/T2400/T2500/ T2600 (2 MB L2 cache, 1.66/1.83/2/2.16 GHz, 667 MHz FSB) (for Aspire 5570)</li> <li>• Mobile Intel® 945GM/PM Express chipset</li> <li>• Intel® PRO/Wireless 3945ABG network connection (dual-band tri-mode 802.11a/b/g) or Intel® PRO/Wireless 3945BG network connection (dual-mode 802.11b/g) Wi-Fi CERTIFIED™ solution, supporting Acer SignalUp™ wireless technology</li> </ul> </li> <li>• Intel® Celeron® M processor 410/420/430 (1 MB L2 cache, 1.46/1.60/1.73 GHz, 533 MHz FSB) or higher (for Aspire 3680)</li> <li>• Mobile Intel® 940GML Express chipset (for Aspire 3680)</li> </ul>
System memory	<p>Up to 2 GB of DDR2 533/667 MHz system memory, upgradeable to 4 GB using two soDIMM modules (dual-channel support)</p> <p>256/512 MB of DDR2 533 MHz memory, upgradeable to 2 GB using two soDIMM modules (dual-channel support) (for Aspire 3680)</p>

Display and graphics	<ul style="list-style-type: none"> <li>• 14.1" WXGA Acer CrystalBrite™ TFT LCD, 1280 x 800 pixel resolution, supporting simultaneous multi-window viewing on dual displays via Acer GridVista™ (for selected models)</li> <li>• NVIDIA® GeForce® Go 7300 up to 256 MB TurboCache™ (128 MB of dedicated GDDR2 VRAM, up to 128 MB of shared system memory), supporting Microsoft® DirectX® 9.0, Shader Model 3.0, OpenEXR High Dynamic Range (HDR) technology, NVIDIA® PowerMizer™ 6.0, PCI Express® (for selected models)</li> <li>• Mobile Intel® 945GM Express chipset with integrated 3D graphics, featuring Intel® Graphics Media Accelerator 950, up to 224 MB of shared memory, supporting Microsoft® DirectX® 9.0 and PCI Express®</li> <li>• Mobile Intel® 940GML Express chipset with integrated 3D graphics, featuring Intel® Graphics Media Accelerator (GMA) 950, up to 224 MB of shared system memory, supporting Microsoft® DirectX® 9.0, dual independent display (for Aspire 3680)</li> <li>• Dual independent displays supported (for selected models)</li> <li>• 16.7 million colors</li> <li>• Simultaneous LCD and CRT display, with LCD panel refresh rate at 70 Hz</li> <li>• Up to 2048 x 1536 resolution via non-interlaced CRT display</li> <li>• MPEG-2/DVD hardware-assisted capability</li> <li>• Acer CinemaVision™ video technology (Acer Arcade)</li> <li>• Acer ClearVision™ video optimization (Acer Arcade)</li> </ul>
Storage subsystem	<ul style="list-style-type: none"> <li>• 40/60/80/100/120/160 GB hard disk drive</li> <li>• Optical drive options: <ul style="list-style-type: none"> <li>• 8X DVD-Super Multi double-layer</li> <li>• DVD/CD-RW combo (for selected models)</li> </ul> </li> <li>• 5-in-1 card reader, supporting Memory Stick® (MS), Memory Stick PRO™ (MS PRO), MultiMediaCard (MMC), Secure Digital (SD) and xD-Picture Card™ (xD)</li> </ul>
Dimensions and weight	<ul style="list-style-type: none"> <li>• 341 (W) x 251 (D) x 28/35 (H) mm (13.4 x 9.88 x 1.10/1.37 inches)</li> <li>• 2.4 kg (5.28 lbs.)</li> </ul>

---

Power subsystem	<ul style="list-style-type: none"><li>• ACPI 2.0 CPU power management standard: supports Standby and Hibernation power-saving modes</li><li>• 44 .4W 4000 mAh (6-cell) Li-ion battery pack</li><li>• Acer QuicCharge™ technology: (for selected models)<ul style="list-style-type: none"><li>• 80% charge in 1 hour</li><li>• 2-hour rapid charge system-off</li><li>• 2.5-hour charge-in-use</li></ul></li><li>• 90 W AC adapter (for selected models)</li><li>• 65 W AC adapter</li></ul>
Input devices	<ul style="list-style-type: none"><li>• 88-/89-key keyboard</li><li>• Touchpad with 4-way scroll button</li><li>• Four easy-launch buttons</li><li>• Six media keys: volume up/down, play/pause, stop, next, previous (for selected models)</li><li>• Two front-access LED-switches: WLAN, Bluetooth®</li></ul>
Audio	<ul style="list-style-type: none"><li>• Audio system with two built-in speakers</li><li>• Intel® High-Definition audio support</li><li>• Sound Blaster Pro™ and MS Sound compatible</li><li>• S/PDIF (Sony/Philips Digital Interface) support for digital speakers</li><li>• Built-in microphone</li></ul>

---

Communication	<ul style="list-style-type: none"> <li>• Modem: 56K ITU V.92 with PTT approval; Wake-on-Ring ready</li> <li>• LAN: <ul style="list-style-type: none"> <li>• gigabit Ethernet; Wake-on-LAN ready (for selected models)</li> <li>• Fast Ethernet; Wake-on-LAN ready</li> </ul> </li> <li>• WLAN: <ul style="list-style-type: none"> <li>• Intel® PRO/Wireless 3945ABG network connection (dual-band tri-mode 802.11a/b/g) or Intel® PRO/Wireless 3945BG network connection (dual-mode 802.11b/g) Wi-Fi CERTIFIED™ solution, supporting Acer SignalUp™ wireless technology</li> <li>• Acer InviLink™ 802.11b/g Wi-Fi CERTIFIED™ solution, supporting Acer SignalUp™ wireless technology (for Aspire 3680)</li> </ul> </li> <li>• WPAN: Bluetooth® 2.0+EDR (Enhanced Data Rate)</li> <li>• Acer Video Conference featuring Voice and Video over Internet Protocol (VVoIP) support via Acer OrbiCam and optional Acer Bluetooth® VoIP phone</li> <li>• Acer Orbicam 1.3 megapixel/310,000 pixel CMOS camera (LCD panel-mounted) featuring : <ul style="list-style-type: none"> <li>• 225-degree ergonomic rotation</li> <li>• Acer VisageOn™ technology</li> <li>• Acer PrimaLite™ technology</li> </ul> </li> </ul>
I/O interface	<ul style="list-style-type: none"> <li>• PC Card slot (one Type II)</li> <li>• 5-in-1 card reader (MS/MS PRO/MMC/SD/xD)</li> <li>• Three USB 2.0 ports</li> <li>• IEEE 1394 port (4-pin) (for selected models)</li> <li>• Infrared port (for selected models)</li> <li>• External display (VGA) port</li> <li>• S-video/TV-out (NTSC/PAL) port</li> <li>• Headphones/speaker/line-out jack with S/PDIF support</li> <li>• Microphone-in jack</li> <li>• Line-in jack</li> <li>• Ethernet (RJ-45) port</li> <li>• Modem (RJ-11) port</li> <li>• DC-in jack for AC adapter</li> </ul>
Security	<ul style="list-style-type: none"> <li>• Kensington lock slot</li> <li>• BIOS user and supervisor passwords</li> </ul>



Software	<ul style="list-style-type: none"> <li>• Acer Empowering Technology <ul style="list-style-type: none"> <li>• Acer eDataSecurity Management (for selected models)</li> <li>• Acer eLock Management (for selected models)</li> <li>• Acer ePerformance Management</li> <li>• Acer eRecovery Management</li> <li>• Acer eSettings Management</li> <li>• Acer eNet Management (for selected models)</li> <li>• Acer ePower Management</li> <li>• Acer ePresentation Management</li> </ul> </li> <li>• Acer Arcade™</li> <li>• Acer GridVista™</li> <li>• Acer Launch Manager</li> <li>• Adobe® Reader®</li> <li>• CyberLink® PowerProducer™</li> <li>• Norton AntiVirus™</li> <li>• NTI CD-Maker™</li> </ul>
Options and accessories	<ul style="list-style-type: none"> <li>• Acer Bluetooth® VoIP phone</li> <li>• 9-cell Li-ion battery pack</li> <li>• 6-cell Li-ion 2nd battery pack</li> <li>• 90 W AC adapter (for selected models)</li> <li>• 512 MB, 1 or 2 GB DDR2 533/667 MHz soDIMM modules</li> <li>• External USB floppy disk drive</li> </ul>
Environment	<ul style="list-style-type: none"> <li>• Temperature: <ul style="list-style-type: none"> <li>• Operating: 5 °C to 35 °C</li> <li>• Non-operating: -20 °C to 65 °C</li> </ul> </li> <li>• Humidity (non-condensing): <ul style="list-style-type: none"> <li>• Operating: 20% to 80%</li> <li>• Non-operating: 20% to 80%</li> </ul> </li> </ul>
System compliance	<ul style="list-style-type: none"> <li>• ACPI 2.0</li> <li>• DMI 2.0</li> <li>• Mobile PC 2002</li> <li>• Wi-Fi®</li> </ul>
Warranty	One-year International Travelers Warranty (ITW)



**Note:** The specifications listed above are for reference only. The exact configuration of your PC depends on the model purchased.



.....

**Warning!** For safety reasons, do not use non-compliant parts when adding or changing components. Consult your reseller for purchase options.

# Indicators

The computer has several easy-to-read status indicators:



The front panel indicators are visible even when the computer cover is closed up.

Icon	Function	Description
	Caps Lock	Lights up when Caps Lock is activated.
	Num Lock	Lights up when Num Lock is activated.
	HDD	Indicates when the hard disk drive is active.
	Bluetooth	Indicates the status of Bluetooth communication.
	Wireless LAN	Indicates the status of wireless LAN communication.
	Power	Indicates the computer's power status.
	Battery	Indicates the computer's battery status.



1. **Charging:** The light shows amber when the battery is charging.
2. **Fully charged:** The light shows green when in AC mode.

## Easy-launch buttons

There are several conveniently located easy-launch buttons. They are: mail, Web browser, Empowering Key < *e* > and one user-programmable button.

Press < *e* > to run the Acer Empowering Technology. Please see "**Acer Empowering Technology**" on page 1. The mail and Web browser buttons are pre-set to email and Internet programs, but can be reset by users. To set the Web browser, mail and programmable buttons, run the Acer Launch Manager. See "**Launch Manager**" on page 51.



Easy-launch button	Default application
<i>e</i>	Acer Empowering Technology (user-programmable)
✉	Email application (user-programmable)
🌐	Internet browser (user-programmable)
P	User-programmable

# Touchpad

The built-in touchpad is a pointing device that senses movement on its surface. This means the cursor responds as you move your finger across the surface of the touchpad. The central location on the palmrest provides optimum comfort and support.



## Touchpad basics

The following items show you how to use the touchpad:

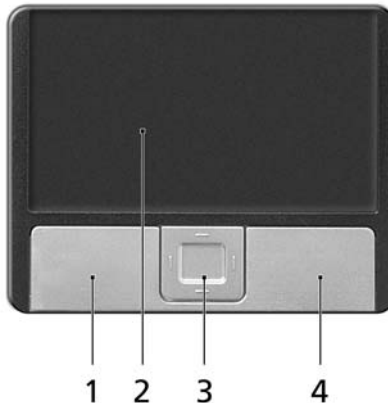

- Move your finger across the touchpad **(2)** to move the cursor.
- Press the left **(1)** and right **(4)** buttons located beneath the touchpad to perform selection and execution functions. These two buttons are similar to the left and right buttons on a mouse. Tapping on the touchpad is the same as clicking the left button.
- Use the 4-way scroll **(3)** button to scroll up or down and move left or right

a page. This button mimics your cursor pressing on the right scroll bar of Windows applications.

Function	Left button (1)	Right button (4)	Main touchpad (2)	Center button (3)
Execute	Quickly click twice.		Tap twice (at the same speed as double-clicking a mouse button).	
Select	Click once.		Tap once.	
Drag	Click and hold, then use finger on the touchpad to drag the cursor.		Tap twice (at the same speed as double-clicking a mouse button); rest your finger on the touchpad on the second tap and drag the cursor.	
Access context menu		Click once.		
Scroll				Click and hold to move up/down/left/right.



.....

**Note:** When using the touchpad, keep it — and your fingers — dry and clean. The touchpad is sensitive to finger movement; hence, the lighter the touch, the better the response. Tapping harder will not increase the touchpad's responsiveness.



.....

**Note:** By default, vertical and horizontal scrolling is enabled on your touchpad. It can be disabled under Mouse settings in Windows Control Panel.

# Using the keyboard

The keyboard has full-sized keys and an embedded numeric keypad, separate cursor, lock, Windows, function and special keys.

## Lock keys and embedded numeric keypad

The keyboard has three lock keys which you can toggle on and off.





Lock key	Description
Caps Lock	When Caps Lock is on, all alphabetic characters typed are in uppercase.
Num Lock <Fn> + <F11>	When Num Lock is on, the embedded keypad is in numeric mode. The keys function as a calculator (complete with the arithmetic operators +, -, *, and /). Use this mode when you need to do a lot of numeric data entry. A better solution would be to connect an external keypad.
Scroll Lock <Fn> + <F12>	When Scroll Lock is on, the screen moves one line up or down when you press the up or down arrow keys respectively. Scroll Lock does not work with some applications.

The embedded numeric keypad functions like a desktop numeric keypad. It is indicated by small characters located on the upper right corner of the keycaps. To simplify the keyboard legend, cursor-control key symbols are not printed on the keys.

Desired access	Num Lock on	Num Lock off
Number keys on embedded keypad	Type numbers in a normal manner.	
Cursor-control keys on embedded keypad	Hold <Shift> while using cursor-control keys.	Hold <Fn> while using cursor-control keys.
Main keyboard keys	Hold <Fn> while typing letters on embedded keypad.	Type the letters in a normal manner.

## Windows keys

The keyboard has two keys that perform Windows-specific functions.

Key	Description
 Windows key	<p>Pressed alone, this key has the same effect as clicking on the Windows Start button; it launches the Start menu. It can also be used with other keys to provide a variety of functions:</p> <ul style="list-style-type: none"> <li>&lt;Windows&gt; + &lt;Tab&gt;: Activates the next Taskbar button.</li> <li>&lt;Windows&gt; + &lt;E&gt;: Opens the My Computer window.</li> <li>&lt;Windows&gt; + &lt;F1&gt;: Opens Help and Support Center.</li> <li>&lt;Windows&gt; + &lt;F&gt;: Opens the Search Results window.</li> <li>&lt;Windows&gt; + &lt;R&gt;: Opens the Run dialog box.</li> <li>&lt;Windows&gt; + &lt;M&gt;: Minimizes all windows.</li> <li>&lt;Shift&gt; + &lt;Windows&gt; + &lt;M&gt;: Undoes the minimize all windows action.</li> </ul>
 Application key	This key has the same effect as clicking the right mouse button; it opens the application's context menu.













## Hotkeys

The computer employs hotkeys or key combinations to access most of the computer's controls like screen brightness, volume output and the BIOS utility.

To activate hotkeys, press and hold the <Fn> key before pressing the other key in the hotkey combination.





Hotkey	Icon	Function	Description
<Fn> + <F1>		Hotkey help	Displays help on hotkeys.
<Fn> + <F2>		Acer eSettings	Launches Acer eSettings in Acer Empowering Technology. See <b>"Acer Empowering Technology" on page 1.</b>
<Fn> + <F3>		Acer ePower Management	Launches Acer ePower Management in Acer Empowering Technology. See <b>"Acer Empowering Technology" on page 1.</b>
<Fn> + <F4>		Sleep	Puts the computer in Sleep mode.
<Fn> + <F5>		Display toggle	Switches display output between the display screen, external monitor (if connected) and both.
<Fn> + <F6>		Screen blank	Turns the display screen backlight off to save power. Press any key to return.
<Fn> + <F7>		Touchpad toggle	Turns the internal touchpad on and off.
<Fn> + <F8>		Speaker toggle	Turns the speakers on and off.
<Fn> + <↑>		Volume up	Increases the sound volume.
<Fn> + <↓>		Volume down	Decreases the sound volume.
<Fn> + <→>		Brightness up	Increases the screen brightness.
<Fn> + <←>		Brightness down	Decreases the screen brightness.

## Special keys

You can locate the Euro symbol and the US dollar sign at the upper-center and/or bottom-right of your keyboard.



### The Euro symbol

- 1 Open a text editor or word processor.
- 2 Either press < € > at the bottom-right of the keyboard, or hold <Alt Gr> and then press the <5> key at the upper-center of the keyboard.



.....

**Note:** Some fonts and software do not support the Euro symbol. Please refer to [www.microsoft.com/typography/faq/faq12.htm](http://www.microsoft.com/typography/faq/faq12.htm) for more information.

### The US dollar sign

- 1 Open a text editor or word processor.
- 2 Either press < \$ > at the bottom-right of the keyboard, or hold <Shift> and then press the <4> key at the upper-center of the keyboard.



.....

**Note:** This function varies according to the language settings.

## Ejecting the optical (CD or DVD) drive tray

Press the drive eject button to eject the optical drive tray when the computer is on.



Insert a paper clip to the emergency eject hole to eject the optical drive tray when the computer is off.

## Using a computer security lock

The notebook comes with a Kensington-compatible security slot for a security lock.



Wrap the computer security lock cable around an immovable object such as a table or handle of a locked drawer. Insert the lock into the notch and turn the key to secure the lock. Keyless models are also available.

# Audio

The computer comes with 32-bit Intel High-Definition audio, and built-in stereo speakers.



## Adjusting the volume

Use hotkeys to easily adjust the volume on your computer. See **"Hotkeys"** on **page 32** for more information on adjusting the speaker volume.

# Using Acer Bluetooth<sup>®</sup> VoIP Phone

## 1. Getting to know your VoIP phone





### 1.1 Package contents

Check the following items in your Bluetooth VoIP phone package:

1. Acer Bluetooth VoIP phone
2. Quick guide

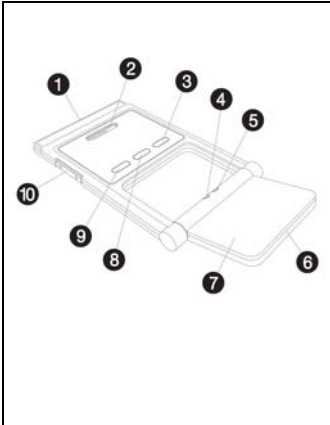
Contact your retailer immediately if any of the items is damaged or missing.

### 1.2 Layout

	1	PC Card (PCMCIA) interface connector
	2	Speaker
	3	Power button 
	4	Bluetooth connection/pairing indicator
	5	Charge/Power indicator
	6	Microphone
	7	Flip
	8	Bluetooth connection/pairing button 
	9	Speakerphone button 
	10	Volume up/down button

## 1.3 LED indicators

LED	Color	Status	Description
Bluetooth connection/ pairing indicator	Blue	Blinking fast	The phone is in pairing mode.
		Blinking slow	The phone is linking with the notebook.
		Off	The phone is not paired or linked with the notebook.
Charge/Power indicator	Amber	On	The phone is charging.
		Off	The phone is fully-charged.
		Blinking	The phone needs to be recharged.

## 1.4 Charging the phone

You need to charge the phone before initial use. It takes approximately four hours for a full charge.

To charge the phone:

1. Turn the notebook on.
2. Locate the PC Card (PCMCIA) slot.
3. Insert the phone to the slot label up. Make sure that the phone is completely pushed on the slot.

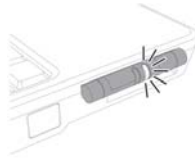



**Note:** The notebook detects the device and displays a **New Device Wizard** window. Click **No, not this time**, then close the window.

4. The power/charge indicator lights up during charge and turns off when the battery is full. Eject the phone from the PC Card slot when charging is finished.

## 2. Connecting the phone to your notebook

The Acer VCM Bluetooth Headset Connection Center is a convenient tool to connect the phone to your notebook.

To connect the phone to your notebook:

1. Eject the phone from the PC Card slot, if necessary, then press the phone power button for three seconds. The phone beeps twice and the charge/power LED flashes to indicate that the phone is on.
2. Press the Bluetooth connection/pairing button  for three seconds to put the phone in "pair-link mode". The phone beeps, and the connection/pairing and charge/power LEDs flash alternately.
3. Right-click the Acer VCM icon  on the taskbar, then select **Bluetooth Headset Connection Center...** from the pop-up menu. If you have not paired any Bluetooth headset devices with the notebook previously, Acer VCM automatically scans all Bluetooth headset devices within range, then displays them in the **Bluetooth Headset List** with a **New** status. Otherwise, any previously paired Bluetooth headset device shows **"Read to Use"**.

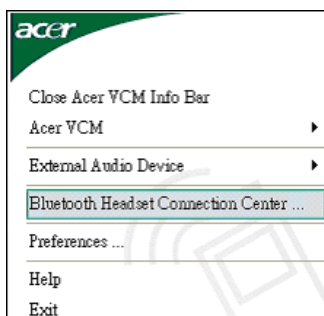

4. Click the **Acer Bluetooth VoIP Phone** from the list, then click **Connect**. Acer VCM automatically pairs the phone to the notebook, then changes the phone status to **"Default Use"**.

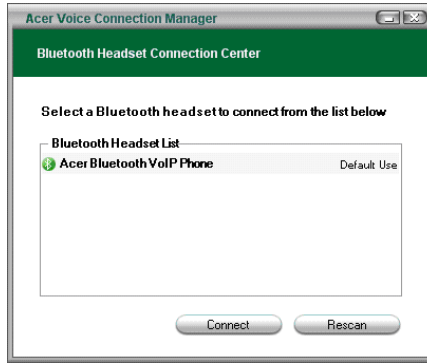

.....

**Note:** Click **Rescan** if the Acer Bluetooth VoIP Phone does not appear on the list. After pairing, Acer VCM automatically connects the phone to the notebook each time you turn the phone on. There is no need to connect the phone again.



### 3. Using the phone

You can use the phone in handheld or hands-free (speakerphone) mode. When you receive an Internet call from your Instant Messaging service (i.e. MSN<sup>®</sup> Messenger, Skype), press the Bluetooth connection/pairing button . The incoming call voice automatically diverts to the phone speaker so you can receive the call.



-----

**Note:** You can only receive/answer Internet calls through the phone when it is linked to the notebook. Every time you turn the phone on, Acer VCM automatically links it to the notebook. When linked, the Bluetooth connection/pairing indicator on the phone blinks slowly.

To switch to hands-free mode, rotate the phone flip counterclockwise, then press the speakerphone button . Refer to the illustration.



# Acer OrbiCam (for selected models)

The Acer OrbiCam is a 1.3 megapixel/310,000 pixel CMOS camera appropriately mounted on top of the LCD panel. The camera's 225-degree ergonomic rotation allows you to capture high-resolution photos or videos up front or at the back of the LCD panel. The Acer OrbiCam fully supports the Acer Video Conference technology so you transmit the best video conference quality over an Instant Messenger service.

## Getting to know your Acer OrbiCam

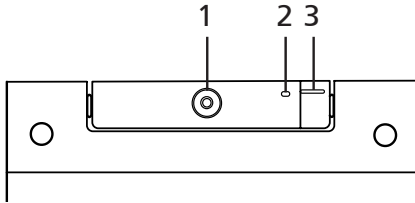

#	Item
1	Lens
2	Power indicator
3	Rubber grip (selected models only)

## Rotating the Acer OrbiCam

The Acer OrbiCam rotates 225 degrees counterclockwise to achieve the desired angle. Refer to the illustrations below.

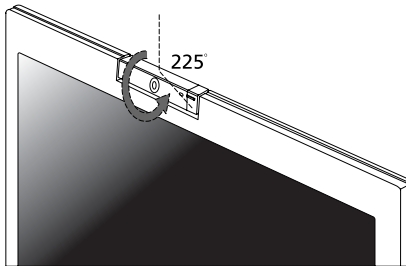

**Note:** DO NOT rotate the camera clockwise to prevent damage to the device.

For your convenience, the camera snaps to 45 degrees to match the position of your face in front or at the back of the LCD panel.

## Launching the Acer OrbiCam

To launch the Acer OrbiCam, double-click on the Acer OrbiCam logo in the desktop.

OR

Click **Start > (All) Programs > Acer > Acer OrbiCam**. The Acer OrbiCam capture window appears.

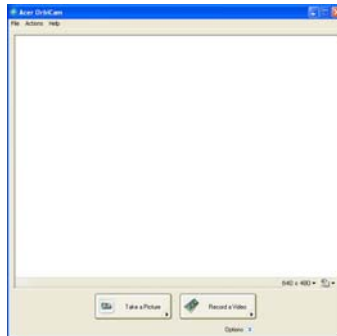

## Changing the Acer OrbiCam settings

### Resolution

To change the capture resolution, click the displayed resolution at the bottom right corner of the capture window, then select the desired resolution.



**Note:** Setting the camera resolution to 640 x 480 or larger does not change the capture window size.

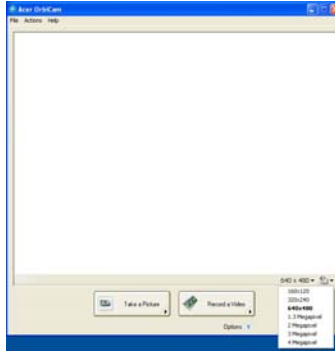

## Options

Click **Options** to display the **Window**, **Preview**, and **Folder** tabs. Use the options to change the capture window size, preview settings, and the folder for captured photos or videos.

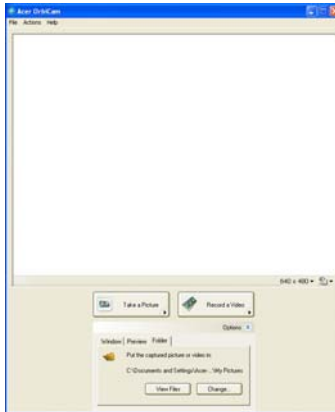

## Camera Settings

### Basic settings

Click the Camera Settings icon on the bottom right corner of the capture display, then select **Camera Settings** from the pop-up menu. You can adjust the **Video**, **Audio**, and **Zoom/Face tracking** options from this window.

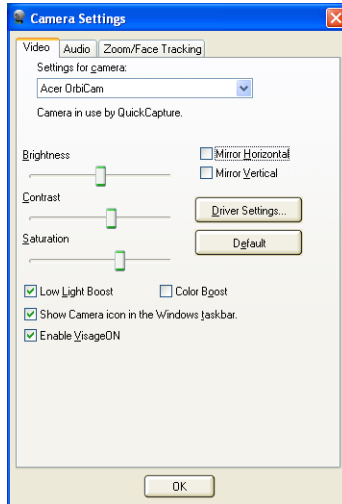

### Capture settings

From the Camera Settings window, click the **Driver Settings** button. The **Properties** window appears.

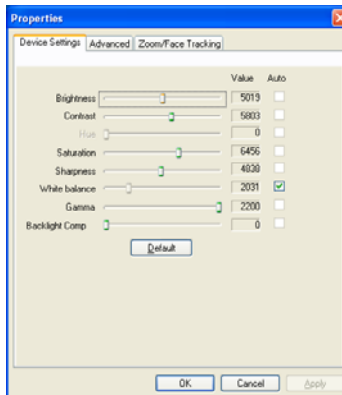

**Device Settings** allows you to change the camera brightness, contrast, hue, saturation, sharpness, etc.

**Advanced Settings** allows you to activate gain control, implement image mirror, select image enhancements and anti-flicker settings, and turn on/off the camera indicator.

**Zoom/Face Track Settings** allows you to adjust the zoom level and turn the face-tracking feature on or off.

## Capturing photos/videos

To capture a photo or a video clip, rotate the Acer OrbiCam to get the desired angle, then click the **Take a Picture** or **Record a Video** button. The **Windows Picture and Fax Viewer** or the **Windows Media Player** automatically launches to display/play a preview of the photo/video clip.



.....

**Note:** By default, all photos and videos are saved in the **My Pictures** and **My Videos** folder.

## Using the Acer OrbiCam as webcam

The Acer OrbiCam is automatically selected as the capture device of any Instant Messenger (IM) application. To use the Acer OrbiCam as a webcam, open the IM service, then select the video/webcam feature. You can now broadcast from your location to an IM partner anywhere in the world.

## Enabling the Acer VisageON (for selected models)

The **Acer VisageON** technology comes with two features: **Face tracking** and **Video effects** (selected models only). The face tracking feature tracks your head movement and automatically centers your face in the capture window. The video effects feature allows you to select and apply an effect to your video transmissions.



.....

**Note:** The face tracking feature is not capable of centering your face beyond the capture window frame. Minimal head movements are tracked more efficiently.

To enable the Acer VisageON:

- 1 Right-click on this icon, then select **VisageON** from the pop-up menu.

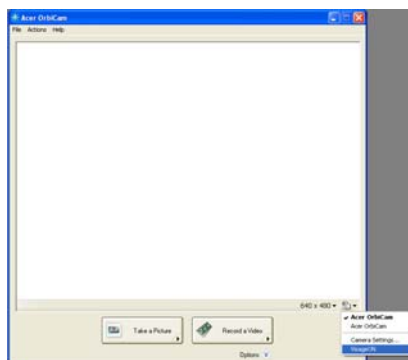

The VisageON window appears.



- 2 Select and apply a video effect from the left section of the VisageON window. Change the face tracking settings and options from the right section.

## Using the face tracking feature

To use the face tracking feature:

- 1 Click the left icon down arrow button, then select **Single User** or **Multiple Users** from the pop-up menu. For multiple users, the face tracking feature automatically centers all the users' face in the capture window, otherwise the utility centers the face of the user closest to the camera.

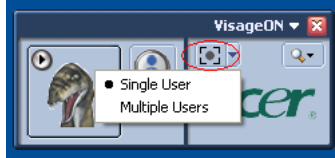

- 2 Click the right icon to zoom in/out or reset the current view.

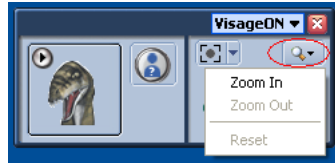

- 3 Click **VisageON** to display a pop-menu that allows configuration of the camera, face tracking and video effects settings.

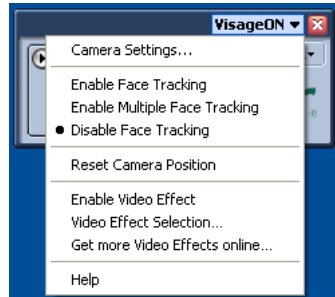



## Using video effects (selected models only)

The **Video Settings** section allows you to select an avatar or accessory video effect from the list. To select an effect:

- 1 Click the encircled icon to display the available video effects. The **Video Effect Selection** window appears.



- 2 Click on a video effect to use. The selected effect appears in the video effects section of the VisageON window.

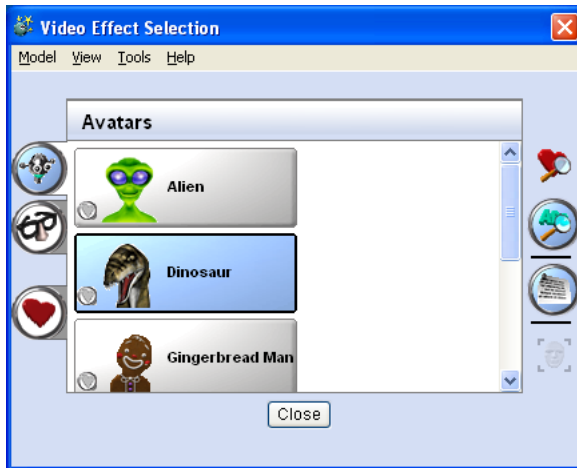

### Note:

1. When using avatars, you may have to calibrate the face points to achieve better tracking. Follow screen instructions from the VisageON window to continue.
2. You may use video effects when using the camera for IM chat/video sessions or call conferences.

# Using the system utilities



**Note:** The system utilities work under Microsoft Windows XP only.

## Acer GridVista (dual-display compatible)



**Note:** This feature is only available on certain models.

To enable the dual monitor feature of your notebook, first ensure that the second monitor is connected, then, select **Start, Control Panel, Display** and click on **Settings**. Select the secondary monitor (2) icon in the display box and then click the check box **Extend my Windows desktop onto this monitor**. Finally, click **Apply** to confirm the new settings and click **OK** to complete the process.

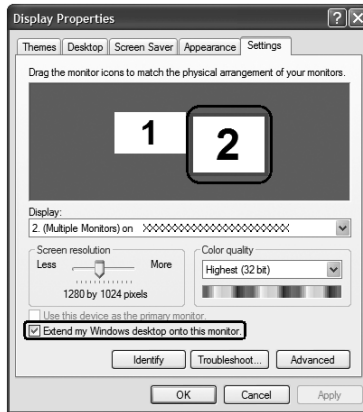

Acer GridVista is a handy utility that offers four pre-defined display settings so you can view multiple windows on the same screen. To access this function, please go to **Start, All Programs** and click on **Acer GridVista**. You may choose any one of the four display settings indicated below:

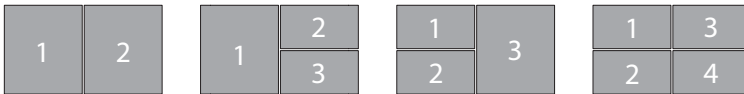

Double (vertical), Triple (primary at left), Triple (primary at right), or Quad  
Acer GridVista is dual-display compatible, allowing two displays to be partitioned independently.

Acer GridVista is simple to set up:

- 1 Run Acer GridVista and select your preferred screen configuration for each display from the taskbar.
- 2 Drag and drop each window into the appropriate grid.
- 3 Enjoy the convenience of a well-organized desktop.

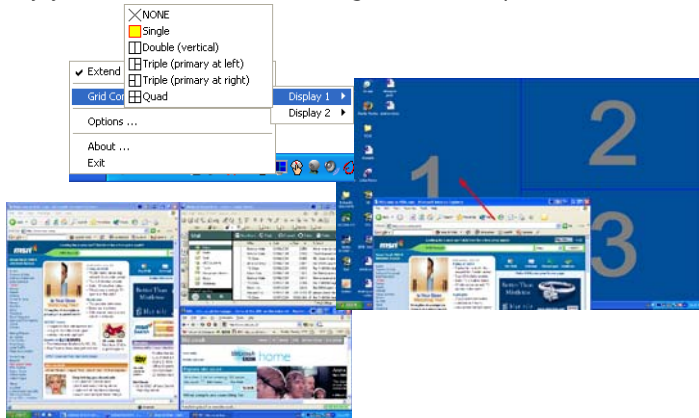

**Note:** Please ensure that the resolution setting of your second monitor is set to the manufacturer's recommended value.

## Launch Manager

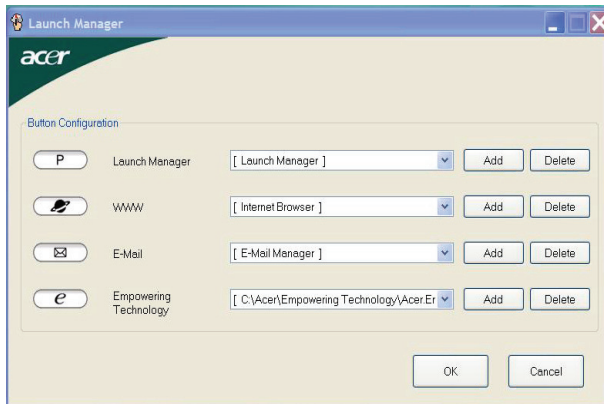

Launch Manager allows you to set the four easy-launch buttons located above the keyboard. **"Easy-launch buttons"** on page 28 for the location of the easy-launch buttons.

You can access the Launch Manager by clicking on **Start, (All) Programs,** and then **Launch Manager** to start the application.

## Norton AntiVirus

Norton AntiVirus is an anti-virus software that finds and repairs infected files, and protects against viruses to keep your computer data safe and secure.

### How do I check for viruses?

A Full System Scan scans all files on your computer. To perform a system scan:

- 1 Start Norton AntiVirus.

Double click on the **Norton AntiVirus** icon on the desktop or click on the **Start** menu in the Windows taskbar, highlight **Programs,** and select **Norton AntiVirus.**

- 2 In the Norton AntiVirus main window, click **Scans.**

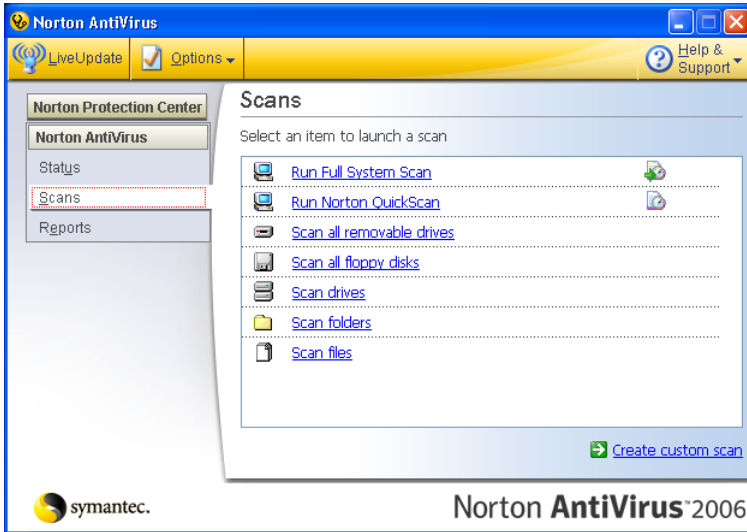

- 3 In the **Scans** panel, click **Run Full System Scan.**

- 4 When the scan is complete, a scan summary appears. Click **Finished.**

You can schedule customized virus scans that run unattended on specific dates and times or at periodic intervals. If you are using the computer when the scheduled scan begins, it runs in the background so that you do not have to stop working.

For more information refer to the Norton AntiVirus Help menu.

# Frequently asked questions

The following is a list of possible situations that may arise during the use of your computer. Easy solutions are provided for each one.

## I turned on the power, but the computer does not start or boot up.

Look at the power indicator:

- If it is not lit, no power is being supplied to the computer. Check the following:
  - If you are using on the battery, it may be low and unable to power the computer. Connect the AC adapter to recharge the battery pack.
  - Make sure that the AC adapter is properly plugged into the computer and to the power outlet.
- If it is lit, check the following:
  - Is a non-bootable (non-system) disk in the external USB floppy drive? Remove or replace it with a system disk and press **<Ctrl> + <Alt> + <Del>** to restart the system.

## Nothing appears on the screen.

The computer's power management system automatically blanks the screen to save power. Press any key to turn the display back on.

If pressing a key does not turn the display back on, three things might be the cause:

- The brightness level might be too low. Press **<Fn> + <←>** (increase) to adjust the brightness level.
- The display device might be set to an external monitor. Press the display toggle hotkey **<Fn> + <F5>** to toggle the display back to the computer.
- If the Sleep indicator is lit, the computer is in Sleep mode. Press and release the power button to resume.

## Image is not full-screen.

Each computer display has a different native resolution depending on the screen. If you set the resolution lower than this native resolution, the screen expands to fill the computer display. Right-click on your Windows desktop and select **Properties** to bring up the "Display Properties" dialog box. Then click on the **Settings** tab to make sure that the resolution is set to the appropriate resolution. Resolutions lower than the specified resolution are not full-screen on the computer or on an external monitor.

## No audio is heard from the computer.

Check the following:

- The volume may be muted. In Windows, look at the volume control (speaker) icon on the taskbar. If it is crossed-out, click on the icon and deselect the **Mute all** option.
- The volume level may be too low. In Windows, look at the volume control icon on the taskbar. You can also use the volume control buttons to adjust the volume. See "**Hotkeys**" on page 32 for more detail.
- If headphones, earphones or external speakers are connected to the line-out port on the computer, the internal speakers automatically turn off.

## I want to eject the optical drive tray without turning on the power.

There is a mechanical eject hole on the optical drive. Simply insert the tip of a pen or paperclip into the hole and push to eject the tray. (If your computer's optical drive is a slot-load model, it will not have an eject hole.)

## The keyboard does not respond.

Try attaching an external keyboard to a USB port on the computer. If it works, contact your dealer or an authorized service center as the internal keyboard cable may be loose.

## The infrared port does not work.

Check the following:

- Make sure that the infrared ports of the two devices are facing each other (+/- 15 degrees) a maximum of 1 meter apart.
- Make sure there is a clear path between the two infrared ports. Nothing should be blocking the ports.
- Make sure you have the appropriate software running on both devices (for file transfers) or you have the appropriate drivers (for printing to an infrared printer).
- During the POST, press <F2> to access the BIOS utility and verify that the infrared port is enabled.
- Make sure both devices are IrDA-compliant.

## The printer does not work.

Check the following:

- Make sure that the printer is connected to a power outlet and that it is turned on.
- Make sure that the printer cable is connected securely to the computer's parallel port or a USB port and the corresponding port on the printer.

I want to set up my location to use the internal modem.

To properly use your communication software (e.g. HyperTerminal), you need to set up your location:

- 1 Click on **Start, Settings, Control Panel**.
- 2 Double-click on **Phone and Modem Options**.
- 3 Click on **Dialing Rules** and begin setting up your location.

Refer to the Windows manual.



.....

**Note:** Please note, on first booting your notebook, that you can skip the Internet Connection setup, as it is not necessary to complete the installation of your Operating System. After the Operating System is set up, you can proceed with the Internet Connection setup.

I want to restore my computer to its original settings without recovery CDs.



.....

**Note:** If your system is the multilingual version, the operating system and language you choose when you first turn on the system will be the only option for future recovery operations.

This recovery process helps you restore the C: drive with the original software content that is installed when you purchase your notebook. Follow the steps below to rebuild your C: drive. (Your C: drive will be reformatted and all data will be erased.) It is important to back up all data files before using this option.

Before performing a restore operation, please check the BIOS settings.

- 1 Check to see if **Acer disk-to-disk recovery** is enabled or not.
- 2 Make sure the **D2D Recovery** setting in **Main** is **Enabled**.
- 3 Exit the BIOS utility and save changes. The system will reboot.



.....

**Note:** To activate the BIOS utility, press <F2> during POST.

To start the recovery process:

- 1 Restart the system.
- 2 While the Acer logo is showing, press <Alt> + <F10> at the same time to enter the recovery process.
- 3 Refer to the onscreen instructions to perform system recovery.



.....

**Important!** This feature occupies 2 to 3 GB in a hidden partition on your hard disk.

## Requesting service

### International Travelers Warranty (ITW)

Your computer is backed by an International Travelers Warranty (ITW) that gives you security and peace of mind when traveling. Our worldwide network of service centers are there to give you a helping hand.

An ITW passport comes with your computer. This passport contains all you need to know about the ITW program. A list of available, authorized service centers is in this handy booklet. Read this passport thoroughly.

Always have your ITW passport on hand, especially when you travel, to receive the benefits from our support centers. Place your proof-of-purchase in the flap located inside the front cover of the ITW passport.

If the country you are traveling in does not have an Acer-authorized ITW service site, you can still get in contact with our offices worldwide. Please consult <http://global.acer.com>.

### Before you call

Please have the following information available when you call Acer for online service, and please be at your computer when you call. With your support, we can reduce the amount of time a call takes and help solve your problems efficiently. If there are error messages or beeps reported by your computer, write them down as they appear on the screen (or the number and sequence in the case of beeps).

You are required to provide the following information:

Name: \_\_\_\_\_

Address: \_\_\_\_\_

Telephone number: \_\_\_\_\_

Machine and model type: \_\_\_\_\_

Serial number: \_\_\_\_\_

Date of purchase: \_\_\_\_\_



# Acer Arcade

Acer Arcade is an integrated player for music, photos, TV, DVD movies and videos. It can be operated using your pointing device or remote control.

To watch or listen, click or select a content button (e.g., Music, Video, etc.) on the Arcade home page.



- **Music** — listen to music files in a variety of formats
- **TV** — watch and record digital or analog TV programs (for selected models)
- **Cinema** — watch DVDs or VCDs
- **Video** — watch and/or edit video clips
- **Album** — view photos stored on your hard disk or removable media



**Note:** While watching videos, DVDs or slide shows, your screensaver and power-saving features are unavailable.

## 48-button remote control

If your Aspire is bundled with a TV-tuner card, a 48-button remote control is included for use with the Acer Arcade software. The table below explains the functions for this controller.

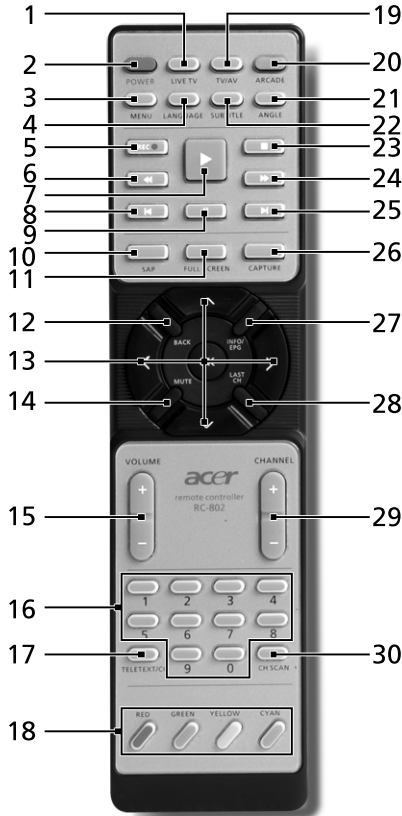

**Warning!** The Arcade and Power buttons have different functions depending on the current mode. See below for details. Button functions may change depending on your power option settings.

To access Arcade in Windows mode, push the **Arcade** button to start Arcade. Push it again at any time to return to the main menu. Pushing the **Arcade** button again will close Arcade mode. Pushing the **Power** button will put your notebook into Standby mode. Push it again to resume.

## Remote functions

#	Item	Description
1	Live TV	Launch Live TV mode
2	Power	Turn off; sleep (depending on mode)
3	Menu	Launch DVD menu screen
4	Language	Open DVD language menu**
5	Record	Record TV
6	Rewind	Rewind through media
7	Play	Play selection
8	Previous	Skip back one music track, DVD chapter, or photo
9	Pause	Pause audio, video, slide shows, live or recorded TV
10	SAP	Toggle between sound modes (mono, stereo, etc.)
11	Full Screen	Toggle between full screen and window view
12	Back	Back to previous page
13	Navigation/ OK buttons	Navigate between selections and menu items, OK to select option, enter, play and pause.
14	Mute	Toggle audio on/off
15	VOL + / -	Increase or decrease the audio playback level
16	0-9 buttons	Enter TV channel numbers
17	TeleText/CC	Launch TeleText*/ closed captions
18	Color buttons	Teletext shortcut functions*
19	TV/AV	Toggle between TV-in and AV-in
20	Arcade	Launch/quit Acer Arcade; return to Arcade main page
21	Angle	Toggle between different viewing angles**
22	Subtitle	Open subtitles menu**
23	Stop	Stop current playing or recording operation
24	Fast Forward	Fast forward through media
25	Next	Skip ahead one music track, DVD chapter, or photo
26	Capture	Capture the current TV/Video screen
27	Info/EPG	Show DVD or TV listings information
28	Last Ch	Return to previous channel
29	Channel	Change channels up and down
30	Ch scan	Shortcut to scan channel page; scan TV channels

\*TeleText regions only. \*\*Dependent on individual DVD content.

## Finding and playing content

Clicking a button on the Arcade home page opens the corresponding feature's home page. The content pages have buttons on the left and a content browsing area on the right. If a button shows one of several choices, such as sort order, the current setting is shown by a brightly colored ball on the button.

To pick content, click an item in the content area. When there is more than one CD or DVD drive, all drives will be shown. Pictures and videos are shown as files (with thumbnails) and organized into folders.

To browse a folder, click to open it. To go back up to the folder above it, click the **Up one level** button. If there is more content than will fit on a page, use the buttons at the lower right to scroll through the pages.



**Note:** For more detailed information on the features of Acer Arcade, please refer to the Arcade Help menu. This can be accessed from the Arcade home page by selecting **Help** .

## Settings

There are settings in Acer Arcade that allow you to fine-tune its performance to suit your machine and your personal preferences. To access Settings, click on this icon  located on the upper-right hand corner of the main page.

Click **Acer Arcade Help** for comprehensive help on each Arcade mode.

### In Display Settings:

Use the "Screen Ratio" option to choose between standard (4:3) or widescreen (16:9) display when watching movies.

The "4:3 Movie Display Type" option allows you to select between "CinemaVision™" or "Letterbox" mode.

- Acer CinemaVision™ is a nonlinear video stretching technology that produces minimal distortion in the center of the picture.
- The **Letterbox** option displays widescreen movie content in its original aspect ratio and adds black bars at the top and bottom of the screen.

"Color profile" allows you to choose between "Original" or "ClearVision™".

- Acer ClearVision™ is a video enhancement technology that detects video content and dynamically adjusts the brightness/contrast/saturation levels so that you do not need to change the color settings if the movie you are watching contains scenes that are overly dark or too bright.

### In Audio Settings:

Use "Speaker Environment" to choose between "Headphones," "SPDIF," "2" or more speakers depending on your audio equipment.

"Output Mode" should be set to "Stereo" if you are listening to speakers, "Dolby Surround," or "Virtual Surround Sound" if you are using headphones.



.....

**Note:** If your speakers are not capable of outputting low-frequency signals, it is recommended that you do not select **Virtual Surround Sound**, in order to avoid damaging your speakers.

Click **Run Setup Wizard** to change your original startup settings.

Click **About Acer Arcade** to open a page with version and copyright information.

Click **Restore Default Settings** to return the Acer Arcade settings to their default values.

## Arcade controls

When watching video clips, movies or slide shows at full screen, two pop-up control panels are shown when you move the pointer. They automatically disappear after several seconds. The "Navigation Controls" panel appears at the top and the "Player Controls" panel appears at the bottom of the screen.

### Navigation controls

To return to the Arcade home page, click the **Home** button in the upper-left corner of the window. To go up one folder level while searching for content, click **Up one level**. To return to the previous screen, click the **red arrow**. The buttons in the upper right (minimize, maximize, close) have standard PC behaviors.

To quit Arcade, click the **Close** button in the upper right corner of the window.

### Player controls

At the bottom of the window, the player controls — used for video, slide shows, TV, movies and music — are shown. The group on the left provides standard playback controls (play, pause, stop, etc.). The group on the right controls volume (mute and volume up/down).



**Note:** When playing DVDs and watching TV, there are additional controls added to the right of the volume controls. These are discussed in more detail in the Cinema and TV sections of this guide.

## Virtual keyboard

Whenever you are required to enter search information, or name a file, DVD or folder, you can use the onscreen virtual keyboard. You can quickly enter the information you need using the mouse, cursor keys or keyboard.



## Background mode

With Acer Arcade you can continue listening to music or watching Live TV while you perform certain other functions. TV, video and music will continue playing in a small window located in the bottom left-hand corner of the screen.

You can press the stop button on the remote or click the onscreen stop icon to stop the playback at anytime.



## Cinema

If your computer came with a DVD drive, you can play movies from DVDs and video CDs (VCDs) with the Cinema function of Acer Arcade. This player has the features and controls of a typical DVD player.

When you insert a disk into the DVD drive, the movie begins playing automatically. To control the movie, the pop-up player control panel appears at the bottom of the window when you move the pointer.

If more than one optical drive contains a playable disk, click the **Cinema** button on the Home page to open the Cinema content page, then select the disk you'd like to watch from the list on the right.

When viewing DVDs, the following special controls are added to the pop-up panel:

- DVD Menu
- Subtitles
- Language
- Snapshot
- Angle

The disk currently playing will be shown in the area above the list of drives. This page is also displayed when you press the **Stop** button during a movie. The buttons on the left side allow you to resume the movie from the point it was stopped, restart the movie from the beginning, jump to the DVD menu, eject the disk, or go to the "DVD Settings" page.

## Settings

To access the settings for Cinema, first click the **"Settings"** button on the main menu, and then click on **Cinema**. This allows you to change "Video" and "Language" settings.

The "Settings" control the audio and subtitle output of DVDs.

"Subtitles" selects the default subtitle language for DVDs when available. The factory setting is "Off."

"Closed Captions" turns on the closed captions on DVDs. This function displays captions encoded in the video signal that describe onscreen action and dialog for the hearing impaired. The factory setting is "Off."

"Audio" selects the default language for DVD titles.

"Display Upon Mute" lets you choose whether to turn on the subtitles or captions when you mute the sound for any reason.

## Album

Acer Arcade lets you view digital photos individually or as a slide show, from any available drive on your computer. Click the **Album** button on the Arcade Home page to show the Album main page.



The content area on the right shows both individual pictures and folders. **Click** on a folder to open it.

To view a slide show, open the folder containing the pictures you wish to view, then click **Play Slide Show**. The slide show is played at full screen. Use the pop-up control panel to control the slide show.

You can also view a single picture by clicking on it. This opens the picture at full screen.

You can then use the onscreen player controls to zoom in and out, and to pan in four directions.

## Editing Pictures

Choose "Edit," and you can "Rotate," "Remove Red Eye," and "Auto Fix" (optimize the brightness and contrast) pictures to improve the appearance of your images.

## Slide Show settings

To change Slide Show settings, click the **Advanced** button on the Album page and select "Settings."

"Slide Duration" determines how long each slide is shown before automatically advancing to the next picture in the slide show.

"Slide Show Transition" sets the style of transition used between pictures; you can choose between Motion, Cell, Fade, Random, Wipe, Slide, Page and None modes.



To add background music to a slide show, click on the **"Slide Show Music"** option. The Slide Show Music page will ask you to choose music from your personal music library.

Click **Load Default Settings** to return your settings to their default values.

## Video

To open the Video function, click **Video** on the Arcade Home page.



**Note:** The Video feature is designed to play back many different kinds of video formats. Refer to the Video help section for a full list of compatible formats. If you want to watch a DVD or VCD, use the "Cinema" function.

### Playing a video file

Click **Play** to watch video files. The Video page shows the video files in the content area on the right side. They are organized by folders and a thumbnail image shows the first frame of each video.

To play a video file, click on it. The video will play at full screen. The pop-up control panel will appear at the bottom of the screen when you move the mouse. To return to the Video page, click **Stop**.

### Capturing video (TV models only)

Acer Arcade allows you to capture and record video clips from other external devices, such as a DVD player or camcorder.

Click **Capture Device** on the video page and then select the source you are using for your video input. There is a choice between "S-video" and "Composite."

To capture a video clip, you then need to click the red record button in the onscreen controls.

The destination folder can be set from the "Settings" menu.

Clicking on **Advanced** and selecting **Settings** allows you to set the quality of the video captured. You can choose from "Good," "Better" or "Best." Selecting a higher quality results in a larger file when capturing video clips.

### Snapshot

Snapshot mode is available in Cinema, Video and TV modes. This function can be used to capture the onscreen image at any time.

A single frame image will be captured and stored in a user designated directory. The destination directory can be changed from the "Settings" menu.

## Editing video

Acer Arcade offers the capability to edit captured video clips, photos and footage from a camcorder into a movie. You can also select a movie style, and add special transition effects and music to create the perfect home movie.

To edit a movie, click **Advanced**, and then select "Edit Video." Then select the clips you wish to edit from your folders. To complete your movie, you may also choose a "Movie Style," "Background Music," the perfect ratio of music and audio, as well as the length of the movie.

"Select Scenes" can be used to include your favorite or the most important scenes, or the editing decisions can be left to the editing program.

Once compiled, the final movie can then be burned to disk to share with family and friends.



**Note:** For more details on editing video and all the associated features, please refer to the Acer Arcade help menu.

## Music

For convenient access to your music collection, click **Music** on the Arcade homepage to open the Music homepage.

Select the folder, CD or category that contains the music you want to listen to. Click **Play** to listen to the entire content from the beginning, or select the song that you want to hear from the list in the content area.

The songs in the folder are shown in the content area, while the left side has controls for "Play," "Shuffle" and "Repeat All." The "Visualize" option allows you to watch computer-generated visuals while you listen to music. When playing music, the control panel at the bottom of the page makes it easy to adjust the volume and control playback.

To rip music from an audio CD, after you have inserted the CD, click **Rip CD**. In the page that opens, select the songs you would like to rip (or click **Select** or **Clear All**), then click **Start Ripping**.

The progress of the ripping operation will be displayed on screen.

You can change the file quality of the ripped tracks by clicking **Settings**.

## TV (for selected models)

Arcade allows you to watch TV from your computer. Click the **TV** button on the home page to show the TV main page.

The **Live TV** option plays TV on screen. Press **Escape** at any time to return to Arcade.

When you watch TV, additional buttons appear on the playback controls: **Channel Up** (switches up one channel), **Channel Down** (switches down one channel), **Snapshot** (takes a snapshot of the current frame of video), **TeleText** (opens the TeleText function), and **Record** (records TV content as a video file).

The **Recorded TV** option allows you to view files that you have recorded from the TV. See Recorded TV.

The **Schedule** option lets you set TV recording schedules for later viewing. See Scheduling Recordings.

The **Program Guide** option lets you view program information for all channels. See Program Guide.

The **Find Program** option enables you to search for a specific kind of program.

The **Settings** button opens a page containing TV settings. See TV settings for more information.



.....

**Note:** For information on setting up and operating the TV mode of Arcade please refer to the separate TV booklet.

## Time-shift functionality

Arcade also has a time-shift function that can be enabled. To create an instant replay, Arcade records the TV broadcast as a file, creating a slight lag between the live broadcast and the TV content that you watch. (The instant replay file cannot be saved, however, and you cannot watch this file in the Recorded TV window.) You can navigate forward and backward within the file to create an instant replay or to skip over commercials.



.....

**Note:** One of your local drives must contain at least 2 GB of free space in order to enable the instant replay function.

Click "||" to pause playback or "▶" to continue watching. Click "◀◀" to rewind or "▶▶" to fast forward. Click "◀" to go to the start of the instant replay recording or click "▶" to go to the end of the instant replay recording.



**Note:** Since the TV content you watch always lags slightly behind the live TV broadcast, going to the end of the instant replay recording is as close to watching live TV as Arcade permits.

## Recorded TV

The "Recorded TV" page shows recorded TV files. A thumbnail image shows the first frame of each file. To **play** a recorded TV file, click it. The video will play at full screen. To return to the TV page, click **Stop**.

For a description of the options on this page, see Videos.

## Scheduling recordings

To set a TV recording schedule, click **Schedule**, then **New Schedule**. In the page that opens, select the **Channel** you want to record and the **scheduling Interval**. Set the **Starting Date**, **Starting Time**, and **Ending Time** of the program you want to record. Click **Confirm Schedule** to activate the recording schedule, or **Cancel** to quit without accepting the schedule. Select **Delete Schedule** to remove a recording schedule you have previously created.

Click an existing recording schedule to open it for modification. To change the order in which schedules are displayed, click **Sort by Channel** or **Sort by Date**.

## Program guide

Click the **Program Guide** button to view program listing details for each channel. These listings and information are provided by the Electronic Program Guide.

## Find program

Clicking the **Find Program** button allows you to search for programs by channel number or category.

## TV settings

To change picture settings, click the **TV** button on the "Settings" page or the **Settings** button on the main TV page. There are four types of TV settings: "Signal," "Channel," "Recording" and "Guide" settings.

## Signal settings

Click on **Capture Device** to select between an analog or digital input for your TV signal.

Select **TV Source** to choose the source of the signal.

The **Region** option allows you to select the country or region where your cable provider is located.

You can also enable and disable the time-shift function.

## Channel settings

If no channel list exists, click **Scan Channels**. Your computer will scan and list the available TV channels. Click **Scan Channels** to rescan and replace your existing channel line-up.

## Recording settings

The **Recording Quality** option allows you to set the quality of video recorded from the TV. Selecting a higher quality results in a larger recorded file when recording TV shows.

You can also select the destination for any recorded TV.

## Guide settings

Click on **EPG Source** to select the source for your EPG program listings. This will differ depending on your region.

Click **Restore Default Settings** to return your settings to their default values.

## Using TeleText functions

For regions with the TeleText service, TeleText can be activated by using the onscreen controller or the remote control.

Pressing the **TeleText** button on the remote will bring up TeleText; press again to bring up transparent mode (the text will have TV pictures in the background), and press once more to return to TV only.

To navigate within the TeleText function, you can:

- Click the color buttons to follow the onscreen color shortcuts.
- Click an onscreen page number to jump to that page.
- Use the number buttons to enter a page number directly.
- Use the up/down buttons on the remote to navigate page numbers, followed by **OK** to select.
- Use the left and right buttons to browse sub-pages.



**Note:** The snapshot function is available when TeleText is running.

## Make DVDs

Acer Arcade provides an easy and complete solution for recording data, audio, photos or videos. You can burn and share any combination of data, music, photos or videos onto a CD or DVD — direct from **Make DVD** mode or some of the other Acer Arcade media modes.

## Authoring CD/DVDs

With Acer Arcade it is possible to create CD or DVDs directly from the main menu, or from whichever media mode you may be using. The burn DVD option can be found in the "Advanced" or "Main" menu of Video, Album and Music media modes.

You can burn your favorite songs to a CD or convert songs from your music collection to MP3 and other popular audio formats. You can even create MP3 CDs with over 100 of your favorite songs and listen to them on your PC or MP3 CD player.

With Arcade, you can also turn digital photos into a slide show with background music, or burn TV and film clips into an amateur movie. You can share any event with your friends and family for playback on most DVD players. You can even add customized theme menus and menu music.

It is also possible to burn combo CD/DVDs with music, photos, film and TV clips all in one. The possibilities are endless!

For specific details about each of these options, click the **Help** button to open the Arcade help menu.

## File type compatibility

For details on file compatibility, please refer to the first page of the Arcade online help menu for each media mode.

# Taking your notebook PC with you

This section gives you tips and hints to consider when moving around or traveling with your computer.

## Disconnecting from the desktop

Follow these steps to disconnect your computer from external accessories:

- 1 Save any open files.
- 2 Remove any media, floppy disks or compact disks from the drive(s).
- 3 Shut down the computer.
- 4 Close the display cover.
- 5 Disconnect the cord from the AC adapter.
- 6 Disconnect the keyboard, pointing device, printer, external monitor and other external devices.
- 7 Disconnect the Kensington lock if you are using one to secure the computer.

## Moving around

When you are just moving within short distances, for example, from your office desk to a meeting room.

## Preparing the computer

Before moving the computer, close and latch the display cover to place it in Sleep mode. You can now safely take the computer anywhere you go within the building. To bring the computer out of Sleep mode, open the display; then press and release the power button.

If you are taking the computer to a client's office or a different building, you may choose to shut down the computer:

Click on **Start, Turn Off Computer**, then click on **Turn Off** (Windows XP).

Or:

You can put the computer in Sleep mode by pressing **<Fn> + <F4>**. Then close and latch the display.

When you are ready to use the computer again, unlatch and open the display; then press and release the power button.



**Note:** If the Sleep indicator is off, the computer has entered Hibernation mode and is turned off. If the power indicator is off but the Sleep indicator is on, the computer has entered Sleep mode. In both cases, press and release the power button to turn the computer back on. Note that the computer may enter Hibernation mode after being in Sleep mode for a period of time.

## What to bring to meetings

If your meeting is relatively short, you probably do not need to bring anything with you other than your computer. If your meeting will be longer, or if your battery is not fully charged, you may want to bring the AC adapter with you to plug in your computer in the meeting room.

If the meeting room does not have an electrical outlet, reduce the drain on the battery by putting the computer in Sleep mode. Press **<Fn> + <F4>** or close the display cover whenever you are not actively using the computer. To resume, open the display (if closed), then press and release the power button.

## Taking the computer home

When you are moving from your office to your home or vice versa.

## Preparing the computer

After disconnecting the computer from your desktop, follow these steps to prepare the computer for the trip home:

- Check that you have removed all media and compact disks from the drive(s). Failure to remove the media can damage the drive head.
- Pack the computer in a protective case that can prevent the computer from sliding around and cushion it if it should fall.



**Caution:** Avoid packing items next to the top cover of the computer. Pressure against the top cover can damage the screen.

## What to take with you

Unless you have some items at home, take the following items with you:

- AC adapter and power cord
- The printed User's Guide



## Special considerations

Follow these guidelines to protect your computer while traveling to and from work:

- Minimize the effects of temperature changes by keeping the computer with you.
- If you need to stop for an extended period of time and cannot carry the computer with you, leave the computer in the trunk of the car to avoid exposing the computer to excessive heat.
- Changes in temperature and humidity can cause condensation. Allow the computer to return to room temperature, and inspect the screen for condensation before turning on the computer. If the temperature change is greater than 10 °C (18 °F), allow the computer to come to room temperature slowly. If possible, leave the computer for 30 minutes in an environment with a temperature between outside and room temperature.

## Setting up a home office

If you frequently work on your computer at home, you may want to purchase a second AC adapter for use at home. With a second AC adapter, you can avoid carrying the extra weight to and from home.

If you use your computer at home for significant periods of time, you might also want to add an external keyboard, monitor or mouse.

## Traveling with the computer

When you are moving within a larger distance, for instance, from your office building to a client's office building or traveling locally.

## Preparing the computer

Prepare the computer as if you were taking it home. Make sure that the battery in the computer is charged. Airport security may require you to turn on your computer when carrying it into the gate area.

## What to take with you

Take the following items with you:

- AC adapter
- Spare, fully-charged battery pack(s)
- Additional printer driver files if you plan to use another printer

## Special considerations

In addition to the guidelines for taking the computer home, follow these guidelines to protect your computer while traveling:

- Always take the computer as carry-on luggage.
- If possible, have the computer inspected by hand. Airport security X-ray machines are safe, but do not put the computer through a metal detector.
- Avoid exposing floppy disks to hand-held metal detectors.

## Traveling internationally with the computer

When you are moving from country to country.

### Preparing the computer

Prepare the computer as you would normally prepare it for traveling.

### What to bring with you

Bring the following items with you:

- AC adapter
- Power cords that are appropriate for the country to which you are traveling
- Spare, fully-charged battery packs
- Additional printer driver files if you plan to use another printer
- Proof of purchase, in case you need to show it to customs officials
- International Travelers Warranty passport

## Special considerations

Follow the same special considerations as when traveling with the computer. In addition, these tips are useful when traveling internationally:

- When traveling in another country, check that the local AC voltage and the AC adapter power cord specifications are compatible. If not, purchase a power cord that is compatible with the local AC voltage. Do not use converter kits sold for appliances to power the computer.
- If you are using the modem, check if the modem and connector is compatible with the telecommunications system of the country you are traveling in.

# Securing your computer

Your computer is a valuable investment that you need to take care of. Learn how to protect and take care of your computer.

Security features include hardware and software locks — a security notch and passwords.

## Using a computer security lock

The notebook comes with a Kensington-compatible security slot for a security lock.

Wrap a computer security lock cable around an immovable object such as a table or handle of a locked drawer. Insert the lock into the notch and turn the key to secure the lock. Some keyless models are also available.

## Using passwords

Passwords protect your computer from unauthorized access. Setting these passwords creates several different levels of protection for your computer and data:

- Supervisor Password prevents unauthorized entry into the BIOS utility. Once set, you must enter this password to gain access to the BIOS utility. See "**BIOS utility**" on page 81.
- User Password secures your computer against unauthorized use. Combine the use of this password with password checkpoints on boot-up and resume from Hibernation for maximum security.
- Password on Boot secures your computer against unauthorized use. Combine the use of this password with password checkpoints on boot-up and resume from Hibernation for maximum security.



**Important!** Do not forget your Supervisor Password! If you forget your password, please get in touch with your dealer or an authorized service center.

## Entering passwords

When a password is set, a password prompt appears in the center of the display screen.

- When the Supervisor Password is set, a prompt appears when you press <F2> to enter the BIOS utility at boot-up.
- Type the Supervisor Password and press <Enter> to access the BIOS utility. If you enter the password incorrectly, a warning message appears. Try again and press <Enter>.
- When the User Password is set and the password on boot parameter is enabled, a prompt appears at boot-up.
- Type the User Password and press <Enter> to use the computer. If you enter the password incorrectly, a warning message appears. Try again and press <Enter>.



.....

**Important!** You have three chances to enter a password. If you fail to enter the password correctly after three tries, the system halts. Press and hold the power button for four seconds to shut down the computer. Then turn on the computer again, and try again.

## Setting passwords

You can set passwords using the BIOS utility.

# Expanding through options

Your notebook PC offers you a complete mobile computing experience.

## Connectivity options

Ports allow you to connect peripheral devices to your computer as you would with a desktop PC. For instructions on how to connect different external devices to the computer, read the following section.

### Fax/data modem

Your computer has a built-in V.92 56 Kbps fax/data modem.



.....  
**Warning! This modem port is not compatible with digital phone lines. Plugging this modem into a digital phone line will damage the modem.**

To use the fax/data modem port, connect a phone cable from the modem port to a telephone jack.

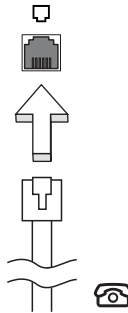

.....  
**Warning! Please make sure that the cable you use is appropriate for the country in which you are working.**

## Built-in network feature

The built-in network feature allows you to connect your computer to an Ethernet-based network.

To use the network feature, connect an Ethernet cable from the Ethernet (RJ-45) port on the chassis of the computer to a network jack or hub on your network.

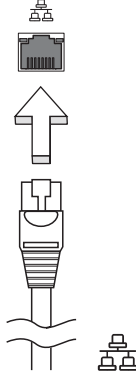

## Fast Infrared (FIR) (for selected models)

The computer's Fast Infrared (FIR) port allows you to do wireless data transfer with other IR-aware computers and peripherals such as PDAs, mobile phones, and infrared printers. The infrared port can transfer data at speeds of up to 4 Mbps at a distance of up to one meter.

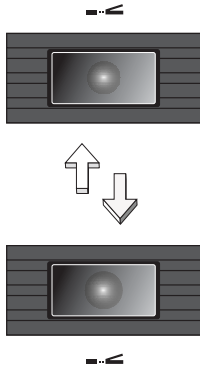

## Universal Serial Bus (USB)

The USB 2.0 port is a high-speed serial bus which allows you to connect USB peripherals without taking up precious system resources.

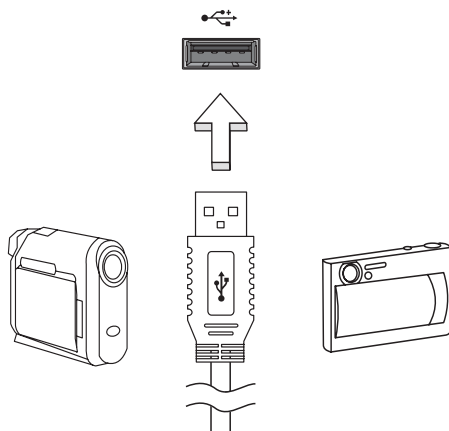

## IEEE 1394 port (for selected models)

The computer's IEEE 1394 port allows you to connect to an IEEE 1394-compatible device like a video camera or digital camera. See your video or digital camera's documentation for details.

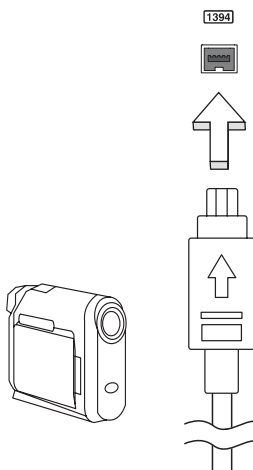

## PC Card slot

The Type II PC Card slot of the computer accepts PC Cards that enhance the usability and expandability of the computer. These cards should have a PC Card logo on them.

PC Cards (formerly PCMCIA) are add-on cards for portable computers, giving you expansion possibilities long afforded by desktop PCs. Popular PC Cards include flash, fax/data modem, wireless LAN and SCSI cards. CardBus improves on the 16-bit PC card technology by expanding the bandwidth to 32 bits.



**Note:** Refer to your card's manual for details on how to install and use the card, and its functions.

### Inserting a PC Card

Insert the card into the slot and make the proper connections (e.g., network cable), if necessary. See your card manual for details.

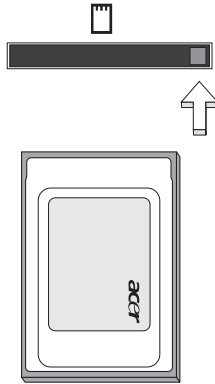

### Ejecting a PC Card

Before ejecting a PC Card:

- 1 Exit the application using the card.
- 2 Left-click on the PC Card icon on the taskbar and stop the card operation.
- 3 Press the slot eject button to pop out the eject button; then press it again to eject the card.

## Installing memory

Follow these steps to install memory:



- 1 Turn off the computer, unplug the AC adapter (if connected) and remove the battery pack. Then turn the computer over to access its base.
- 2 Remove the screws from the memory cover; then lift up and remove the memory cover.
- 3 **(a)** Insert the memory module diagonally into the slot, then **(b)** gently press it down until it clicks into place.

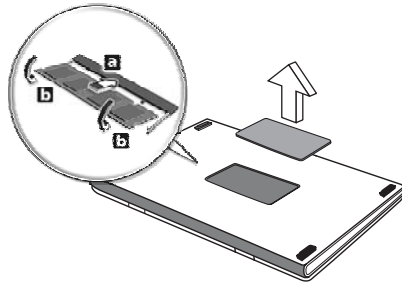

- 4 Replace the memory cover and secure it with the screw.
- 5 Reinstall the battery pack, and reconnect the AC adapter.
- 6 Turn on the computer.

The computer automatically detects and reconfigures the total memory size. Please consult a qualified technician or contact your local Acer dealer.

## BIOS utility

The BIOS utility is a hardware configuration program built into your computer's BIOS.

Your computer is already properly configured and optimized, and you do not need to run this utility. However, if you encounter configuration problems, you may need to run it.

To activate the BIOS utility, press **<F2>** during the POST; while the notebook PC logo is being displayed.

## Boot sequence

To set the boot sequence in the BIOS utility, activate the BIOS utility, then select **Boot** from the categories listed at the top of the screen.

## Enable disk-to-disk recovery

To enable disk-to-disk recovery (hard disk recovery), activate the BIOS utility, then select **Main** from the categories listed at the top of the screen. Find **D2D Recovery** at the bottom of the screen and use the **<F5>** and **<F6>** keys to set this value to **Enabled**.

## Password

To set a password on boot, activate the BIOS utility, then select **Security** from the categories listed at the top of the screen. Find **Password on boot:** and use the **<F5>** and **<F6>** keys to enable this feature.

## Using software

### Playing DVD movies

When the DVD drive module is installed in the optical drive bay, you can play DVD movies on your computer.

- 1 Eject the DVD tray and insert a DVD movie disk; then close the DVD tray.



**Important!** When you launch the DVD player for the first time, the program asks you to enter the region code. DVD disks are divided into 6 regions. Once your DVD drive is set to a region code, it will play DVD disks of that region only. You can set the region code a maximum of five times (including the first time), after which the last region code set will remain permanent. Recovering your hard disk does not reset the number of times the region code has been set. Refer to the table below for DVD movie region code information.

- 2 The DVD movie will automatically play after a few seconds.

Region code	Country or region
1	USA, Canada
2	Europe, Middle East, South Africa, Japan
3	Southeast Asia, Taiwan, South Korea
4	Latin America, Australia, New Zealand
5	Former USSR, parts of Africa, India
6	People's Republic of China



**Note:** To change the region code, insert a DVD movie of a different region into the DVD drive. Please refer to the online help for more information.

## Acer eRecovery Management

Acer eRecovery Management is a tool to quickly backup and restore the system. You can create and save a backup of the current system configuration to hard disk, CD or DVD.

Acer eRecovery Management consists of the following functions:

- 
- 1 Create backup
  - 2 Restore from backup
  - 3 Create factory default image CD, or burn bundled software to an application CD
  - 4 Re-install bundled software without CD
  - 5 Change Acer eRecovery Management password

This chapter will guide you through each process.



.....

**Note:** This feature is only available on certain models. For systems that do not have a built-in optical disk burner, plug in an external USB or IEEE 1394-compatible optical disk burner before entering Acer eRecovery Management for optical disk-related tasks.



.....

Acer eRecovery Management requires a specific hard disk partitioning structure to function. If the system detects that the hard disk does not use this structure, Acer eRecovery Management functionality will be disabled.

## Create backup

You can create and save backup images to hard disk, CD or DVD.

- 1 Boot to Windows XP
- 2 Press **<Alt> + <F10>** to open the Acer eRecovery Management utility.
- 3 Enter the password to proceed. The default password is six zeros.
- 4 In the Acer eRecovery Management window, select **Recovery settings** and click **Next**.
- 5 In the Recovery settings window, select **Backup snapshot image** and click **Next**.
- 6 Select the backup method.
  - a Use **Backup to HDD** to store the backup disk image on drive D:.
  - b **Backup to optical device** to store the backup image on CD or DVD.
- 7 After choosing the backup method, click **Next**.

Follow the instructions on screen to complete the process.

## Restore from backup

You can restore backups previously created (as stated in the **Create backup** section) from hard disk, CD or DVD.

- 1 Boot to Windows XP.
- 2 Press **<Alt> + <F10>** to open the Acer eRecovery Management utility.
- 3 Enter the password to proceed. The default password is six zeros.
- 4 In the Acer eRecovery Management window, select **Recovery actions** and click **Next**.
- 5 Select the desired restore action and follow the onscreen instructions to complete the restore process.



-----  
**Note:** The "Restore C:" item is enabled only if there is a user backup stored on the hard disk (D:\). Please refer to the **Create backup** section.

## Create factory default image CD

When the System CD and Recovery CD are not available, you can create them by using this feature.

- 1 Boot to Windows XP.
- 2 Press **<Alt> + <F10>** to open the Acer eRecovery Management utility.
- 3 Enter the password to proceed. The default password is six zeros.
- 4 In the Acer eRecovery Management window, select **Recovery settings** and click **Next**.
- 5 In the Recovery settings window, select **Burn image to disk** and click **Next**.
- 6 In the Burn image to disk window, select **1. Factory default image** or **2. Application CD** and click **Next**.
- 7 Follow the instructions on screen to complete the process.



**Note:** Select **1. Factory default image** when you want to burn a bootable disk that contains your computer's entire operating system as it was delivered to you from the factory. If you wish to have a disk that will allow you to browse the contents and install selected drivers and applications, select **2. Application CD** — this disk will not be bootable.

## Re-install bundled software without CD

Acer eRecovery Management stores pre-loaded software internally for easy driver and application re-installation.

- 1 Boot to Windows XP.
- 2 Press **<Alt> + <F10>** to open the Acer eRecovery Management utility.
- 3 Enter the password to proceed. The default password is six zeros.
- 4 In the Acer eRecovery Management window, select **Recovery actions** and click **Next**.
- 5 In the Recovery settings window, select **Reinstall applications/drivers** and click **Next**.
- 6 Select the desired driver/application and follow the instructions on screen to re-install.

At first launch, Acer eRecovery Management prepares all the needed software and may take few seconds to bring up the software content window.

## Change password

Acer eRecovery Management and Acer disk-to-disk recovery are protected by a password that can be changed by the user. Follow the steps below to change the password in Acer eRecovery Management.

- 1 Boot to Windows XP.
- 2 Press <Alt> + <F10> to open the Acer eRecovery Management utility.
- 3 Enter the password to proceed. The default password is six zeros.
- 4 In the Acer eRecovery Management window, select **Recovery settings** and click **Next**.
- 5 In the Recovery settings window, select **Password: Change Acer eRecovery Management password** and click **Next**.
- 6 Follow the instructions on screen to complete the process.



.....  
**Note:** If the system crashes, and will not boot to Windows, you can run Acer disk-to-disk recovery to restore the factory default image under DOS mode.

# Troubleshooting

This chapter shows you how to deal with common system problems. Read it before calling a technician if a problem occurs. Solutions to more serious problems require opening up the computer. Do not attempt to open the computer yourself; contact your dealer or authorized service center for assistance.

## Troubleshooting tips

This notebook PC incorporates an advanced design that delivers onscreen error message reports to help you solve problems.

If the system reports an error message or an error symptom occurs, see **"Error messages"** below. If the problem cannot be resolved, contact your dealer. See **"Requesting service"** on page 56.

## Error messages

If you receive an error message, note the message and take the corrective action. The following table lists the error messages in alphabetical order together with the recommended course of action.

Error messages	Corrective action
CMOS battery bad	Contact your dealer or an authorized service center.
CMOS checksum error	Contact your dealer or an authorized service center.
Disk boot failure	Insert a system (bootable) disk into the floppy drive (A:), then press <Enter> to reboot.
Equipment configuration error	Press <F2> (during POST) to enter the BIOS utility, then press <b>Exit</b> in the BIOS utility to reboot.
Hard disk 0 error	Contact your dealer or an authorized service center.
Hard disk 0 extended type error	Contact your dealer or an authorized service center.
I/O parity error	Contact your dealer or an authorized service center.
Keyboard error or no keyboard connected	Contact your dealer or an authorized service center.
Keyboard interface error	Contact your dealer or an authorized service center.
Memory size mismatch	Press <F2> (during POST) to enter the BIOS utility, then press <b>Exit</b> in the BIOS utility to reboot.



If you still encounter problems after going through the corrective measures, please contact your dealer or an authorized service center for assistance. Some problems may be solved using the BIOS utility.

# Regulations and safety notices

## FCC notice

This device has been tested and found to comply with the limits for a Class B digital device pursuant to Part 15 of the FCC rules. These limits are designed to provide reasonable protection against harmful interference in a residential installation. This device generates, uses, and can radiate radio frequency energy and, if not installed and used in accordance with the instructions, may cause harmful interference to radio communications.

However, there is no guarantee that interference will not occur in a particular installation. If this device does cause harmful interference to radio or television reception, which can be determined by turning the device off and on, the user is encouraged to try to correct the interference by one or more of the following measures:

- Reorient or relocate the receiving antenna.
- Increase the separation between the device and receiver.
- Connect the device into an outlet on a circuit different from that to which the receiver is connected.
- Consult the dealer or an experienced radio/television technician for help.

## Notice: Shielded cables

All connections to other computing devices must be made using shielded cables to maintain compliance with FCC regulations.

## Notice: Peripheral devices

Only peripherals (input/output devices, terminals, printers, etc.) certified to comply with the Class B limits may be attached to this equipment. Operation with non-certified peripherals is likely to result in interference to radio and TV reception.

## Caution

Changes or modifications not expressly approved by the manufacturer could void the user's authority, which is granted by the Federal Communications Commission, to operate this computer.

## Operation conditions

This device complies with Part 15 of the FCC Rules. Operation is subject to the following two conditions: (1) this device may not cause harmful interference,

and (2) this device must accept any interference received, including interference that may cause undesired operation.

## Notice: Canadian users

This Class B digital apparatus complies with Canadian ICES-003.

## Remarque à l'intention des utilisateurs canadiens

Cet appareil numérique de la classe B est conforme à la norme NMB-003 du Canada.

## Declaration of Conformity for EU countries

Hereby, Acer, declares that this notebook PC series is in compliance with the essential requirements and other relevant provisions of Directive 1999/5/EC. (Please visit <http://global.acer.com/products/notebook/reg-nb/index.htm> for complete documents.)

Compliant with Russian regulatory certification



ME61

## Modem notices

### Notice for USA

This equipment complies with Part 68 of the FCC rules. Located on the modem is a label that contains, among other information, the FCC Registration Number and Ringer Equivalence Number (REN) for this equipment. Upon request, you must provide this information to your telephone company.

If your telephone equipment causes harm to the telephone network, the telephone company may discontinue your service temporarily. If possible, they will notify you in advance. But, if advance notice is not practical, you will be notified as soon as possible. You will also be informed of your right to file a complaint with the FCC.

Your telephone company may make changes in its facilities, equipment, operations, or procedures that could affect the proper functioning of your equipment. If they do, you will be notified in advance to give you an opportunity to maintain uninterrupted telephone service.

If this equipment should fail to operate properly, disconnect the equipment from the phone line to determine if it is causing the problem. If the problem is with the equipment, discontinue use and contact your dealer or vendor.



.....

**Caution:** To reduce the risk of fire, use only No. 26 AWG or larger UL Listed or CSA Certified Telecommunication Line Cord.

## TBR 21

This equipment has been approved [Council Decision 98/482/EC - "TBR 21"] for single terminal connection to the Public Switched Telephone Network (PSTN). However, due to differences between the individual PSTNs provided in different countries, the approval does not, of itself, give an unconditional assurance of successful operation on every PSTN termination point. In the event of problems, you should contact your equipment supplier in the first instance.

## List of applicable countries

EU member states as of May 2004 are: Belgium, Denmark, Germany, Greece, Spain, France, Ireland, Italy, Luxembourg, the Netherlands, Austria, Portugal, Finland, Sweden, United Kingdom Estonia, Latvia, Lithuania, Poland, Hungary, Czech Republic, Slovak Republic, Slovenia, Cyprus and Malta. Usage allowed in the countries of European Union, as well as Norway, Switzerland, Iceland and Liechtenstein. This device must be used in strict accordance with the regulations and constraints in the country of use. For further information, please contact local office in the country of use.

## Notice for Australia

For safety reasons, only connect headsets with a telecommunications compliance label. This includes customer equipment previously labelled permitted or certified.

## Notice for New Zealand

- 1 The grant of a Telepermit for any item of terminal equipment indicates only that Telecom has accepted that the item complies with minimum conditions for connection to its network. It indicates no endorsement of the product by Telecom, nor does it provide any sort of warranty. Above all, it provides no assurance that any item will work correctly in all respects with another item of Telepermitted equipment of a different make or model, nor does it imply that any product is compatible with all of Telecom's network services.
- 2 This equipment is not capable, under all operating conditions, of correct operation at the higher speeds for which it is designed. Telecom will accept no responsibility should difficulties arise in such circumstances.
- 3 Some parameters required for compliance with Telecom's Telepermit requirements are dependent on the equipment (PC) associated with this device. The associated equipment shall be set to operate within the following limits for compliance with Telecom's Specifications:
  - a There shall be no more than 10 call attempts to the same number within any 30 minute period for any single manual call initiation, and
  - b The equipment shall go on-hook for a period of not less than 30 seconds between the end of one attempt and the beginning of the next call attempt.
- 4 Some parameters required for compliance with Telecom's Telepermit requirements are dependent on the equipment (PC) associated with this device. In order to operate within the limits for compliance with Telecom's specifications, the associated equipment shall be set to ensure that automatic calls to different numbers are spaced such that there is not less than 5 seconds between the end of one call attempt and the beginning of another.
- 5 This equipment shall not be set up to make automatic calls to Telecom's 111 Emergency Service.
- 6 This device is equipped with pulse dialing while the Telecom standard is DTMF tone dialing. There is no guarantee that Telecom lines will always continue to support pulse dialing.
- 7 Use of pulse dialing, when this equipment is connected to the same line as other equipment, may give rise to bell tinkle or noise and may also cause a false answer condition. Should such problems occur, the user should NOT contact the telecom Fault Service.
- 8 This equipment may not provide for the effective hand-over of a call to another device connected to the same line.
- 9 Under power failure conditions this appliance may not operate. Please ensure that a separate telephone, not dependent on local power, is available for emergency use.

## Laser compliance statement

The CD or DVD drive used with this computer is a laser product.  
The CD or DVD drive's classification label (shown below) is located on the drive.

CLASS 1 LASER PRODUCT

CAUTION: INVISIBLE LASER RADIATION WHEN OPEN. AVOID EXPOSURE TO BEAM.

APPAREIL A LASER DE CLASSE 1 PRODUIT

LASERATTENTION: RADIATION DU FAISCEAU LASER INVISIBLE EN CAS D'OUVERTURE. EVITER TOUTE EXPOSITION AUX RAYONS.

LUOKAN 1 LASERLAITE LASER KLASSE 1

VORSICHT: UNSICHTBARE LASERSTRAHLUNG, WENN ABDECKUNG GEÖFFNET NICHT DEM STRAHL AUSSETZEN

PRODUCTO LÁSER DE LA CLASE I

ADVERTENCIA: RADIACIÓN LÁSER INVISIBLE AL SER ABIERTO. EVITE EXPONERSE A LOS RAYOS.

ADVARSEL: LASERSTRÅLING VEDÅBNING SE IKKE IND I STRÅLEN.

VARO! LAVATTAESSA OLET ALTTINA LASERSÄTEILYLLE.

VARNING: LASERSTRÅLNING NÄR DENNA DEL ÄR ÖPPNAD ÄLÅ TUIJOTA SÄTEESEENSTIRRA EJ IN I STRÅLEN

VARNING: LASERSTRÅLNING NÄR DENNA DEL ÄR ÖPPNADSTIRRA EJ IN I STRÅLEN

ADVARSEL: LASERSTRÅLING NÄR DEKSEL ÅPNESSTIRR IKKE INN I STRÅLEN

## LCD pixel statement

The LCD unit is produced with high-precision manufacturing techniques. Nevertheless, some pixels may occasionally misfire or appear as black or red dots. This has no effect on the recorded image and does not constitute a malfunction.

## Macrovision copyright protection notice

**"U.S Patent Nos. 4,631,603; 4,819,098; 4,907,093; 5,315,448; and 6,516,132."**

This product incorporates copyright protection technology that is protected by U.S. patents and other intellectual property rights. Use of this copyright protection technology must be authorized by Macrovision, and is intended for home and other limited viewing uses only unless otherwise authorized by Macrovision. Reverse engineering or disassembly is prohibited.

## Radio device regulatory notice



**Note:** Below regulatory information is for models with wireless LAN and/or Bluetooth only.

### General

This product complies with the radio frequency and safety standards of any country or region in which it has been approved for wireless use. Depending on configurations, this product may or may not contain wireless radio devices (such as wireless LAN and/or Bluetooth modules). Below information is for products with such devices.

### European Union (EU)

This device complies with the essential requirements of the European Council Directives listed below:

73/23/EEC Low Voltage Directive

- **EN 60950-1**

89/336/EEC Electromagnetic Compatibility (EMC) Directive

- **EN 55022**
- **EN 55024**
- **EN 61000-3-2/-3**

99/5/EC Radio & Telecommunications Terminal Equipment (R&TTE) Directive

- **Art.3.1a) EN 60950-1**
- **Art.3.1b) EN 301 489 -1/-17**
- **Art.3.2) EN 300 328-2**
- **Art.3.2) EN 301 893 \*applies to 5 GHz only**

**CE**  (for 5 GHz device)

## List of applicable countries

EU member states as of May 2004 are: Belgium, Denmark, Germany, Greece, Spain, France, Ireland, Italy, Luxembourg, the Netherlands, Austria, Portugal, Finland, Sweden, United Kingdom Estonia, Latvia, Lithuania, Poland, Hungary, Czech Republic, Slovak Republic, Slovenia, Cyprus and Malta. Usage allowed in the countries of European Union, as well as Norway, Switzerland, Iceland and Liechtenstein. This device must be used in strict accordance with the regulations and constraints in the country of use. For further information, please contact local office in the country of use.

## The FCC RF safety requirement

The radiated output power of the wireless LAN Mini PCI Card and Bluetooth card is far below the FCC radio frequency exposure limits. Nevertheless, the notebook PC series shall be used in such a manner that the potential for human contact during normal operation is minimized as follows:

- 1 Users are requested to follow the RF safety instructions on wireless option devices that are included in the user's manual of each RF option device.



**Caution:** To comply with FCC RF exposure compliance requirements, a separation distance of at least 20 cm (8 inches) must be maintained between the antenna for the integrated wireless LAN Mini PCI Card built in to the screen section and all persons.

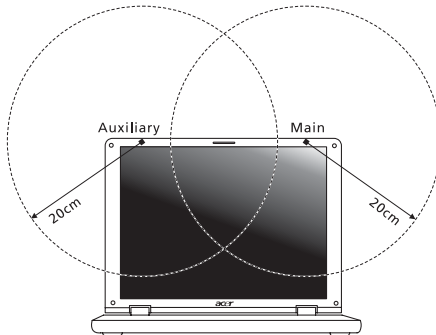

**Note:** The Acer wireless Mini PCI adapter implements a transmission diversity function. The function does not emit radio frequencies simultaneously from both antennas. One of the antennas is selected automatically or manually (by users) to ensure good quality radiocommunication.



- 2 This device is restricted to indoor use due to its operation in the 5.15 to 5.25 GHz frequency range. FCC requires this product to be used indoors for the frequency range 5.15 to 5.25 GHz to reduce the potential for harmful interference to co-channel Mobile Satellite systems.
- 3 High power radar are allocated as primary users of the 5.25 to 5.35 GHz and 5.65 to 5.85 GHz bands. These radar stations can cause interference with and/or damage this device.
- 4 An improper installation or unauthorized use may cause harmful interference to radio communications. Also any tampering of the internal antenna will void the FCC certification and your warranty.

## Canada — Low-power license-exempt radio communication devices (RSS-210)

- a Common information  
Operation is subject to the following two conditions:
    1. This device may not cause interference, and
    2. This device must accept any interference, including interference that may cause undesired operation of the device.
  - b Operation in 2.4 GHz band  
To prevent radio interference to the licensed service, this device is intended to be operated indoors and installation outdoors is subject to licensing.
  - c Operation in 5 GHz band
- The device for the band 5150-5250 MHz is only for indoor usage to reduce potential for harmful interference to co-channel Mobile Satellite systems.
  - High power radars are allocated as primary users (meaning they have priority) of 5250-5350 MHz and 5650-5850 MHz and these radars could cause interference and/or damage to LELAN (Licence-Exempt Local Area Network) devices.

## Federal Communications Commission Declaration of Conformity

This device complies with Part 15 of the FCC Rules. Operation is subject to the following two conditions: (1) This device may not cause harmful interference, and (2) This device must accept any interference received, including interference that may cause undesired operation.

The following local manufacturer/importer is responsible for this declaration:

Product name:	Notebook PC
Model number:	ZR1
Machine type:	Aspire 3680, Aspire 5570 and Aspire 5580
SKU number:	Aspire 368xxx, Aspire 557xxx and Aspire 558xxx ("x" = 0 - 9, a - z, or A - Z)
Name of responsible party:	Acer America Corporation
Address of responsible party:	2641 Orchard Parkway San Jose, CA 95134 USA
Contact person:	Mr. Young Kim
Tel:	408-922-2909
Fax:	408-922-2606

## Declaration of Conformity for CE Marking

Name of manufacturer: Beijing Acer Information Co., Ltd.  
 Address of manufacturer: Huade Building, No.18, ChuangYe Rd.  
 ShangDi Zone, HaiDian District Beijing PRCE marking  
 Contact person: Mr. Easy Lai  
 Tel: 886-2-8691-3089  
 Fax: 886-2-8691-3000  
 E-mail: easy\_lai@acer.com.tw  
 Declares that product: Notebook PC  
 Trade name: Acer  
 Model number: ZR1  
 Machine type: Aspire 3680, Aspire 5570 and Aspire 5580  
 SKU number: Aspire 368xxx, Aspire 557xxx and Aspire 558xxx  
 ("x" = 0 - 9, a - z, or A - Z)

Is in compliance with the essential requirements and other relevant provisions of the following EC directives.

Reference no.	Title
89/336/EEC	Electromagnetic Compatibility (EMC directive)
73/23/EEC	Low Voltage Directive (LVD)
1999/5/EC	Radio & Telecommunications Terminal Equipment Directive (R&TTE)

The product specified above was tested conforming to the applicable Rules under the most accurate measurement standards possible, and all the necessary steps have been taken and are in force to assure that production units of the same product will continue to comply with these requirements.

Easy Lai  
 Easy Lai, Director  
 Regulation Center  
 Environment & Safety

08/2006

Date

## LCD panel ergonomic specifications

Design viewing distance	500 mm
Design inclination angle	0.0°
Design azimuth angle	90.0°
Viewing direction range class	Class IV
Screen tilt angle	85.0°
Design screen illuminance	<ul style="list-style-type: none"> <li>• Illuminance level: <math>[250 + (250\cos\alpha)]</math> lx where <math>\alpha = 85^\circ</math></li> <li>• Color: Source D65</li> </ul>
Reflection class of LCD panel (positive and negative polarity)	<ul style="list-style-type: none"> <li>• Ordinary LCD: Class I</li> <li>• Protective or Acer CrystalBrite™ LCD: Class III</li> </ul>
Image polarity	Both
Reference white: Pre-setting of luminance and color temperature @ 6500K (tested under BM7)	<ul style="list-style-type: none"> <li>• <math>Y_n: 185 \pm 20 \text{ cd/m}^2</math></li> <li>• <math>u'_n: 0.230 \pm 0.03</math></li> <li>• <math>v'_n: 0.459 \pm 0.03</math></li> </ul>
Pixel fault class	Class II



Acer Computer (Shanghai) Limited  
3F, No. 168 Xizang medium road, Huangpu District,  
Shanghai, China



## Declaration of Conformity

We, **Acer Computer (Shanghai) Limited**  
3F, No. 168 Xizang medium road, Huangpu District,  
Shanghai, China

Contact Person: Mr. Easy Lai  
Tel: 886-2-8691-3089 Fax: 886-2-8691-3000  
E-mail: [easy\\_lai@acer.com.tw](mailto:easy_lai@acer.com.tw)

Hereby declare that:

<b>Product:</b>	<b>Personal Computer</b>
<b>Trade Name:</b>	<b>Acer</b>
<b>Model Number:</b>	<b>ZR1</b>
<b>Machine Type:</b>	<b>Aspire 3680, Aspire 5570 and Aspire 5580</b>
<b>SKU Number:</b>	<b>Aspire 368xxx, 557xxx and 558xxx</b> ("x" = 0~9, a~z, or A~Z)

Is compliant with the essential requirements and other relevant provisions of the following EC directives, and that all the necessary steps have been taken and are in force to assure that production units of the same product will continue comply with the requirements.

### **EMC Directive 89/336/EEC as attested by conformity with the following harmonized standards:**

- EN55022:1998 + A1:2000 + A2:2003, AS/NZS CISPR22:2002, Class B
- EN55024:1998 + A1:2001 + A2:2003
- EN61000-3-2:2000, Class D
- EN61000-3-3:1995 + A1:2001
- EN55013:2001 + A1:2003 (applied to models with TV function)
- EN55020:2002 + A1:2003 (applied to models with TV function)

### **Low Voltage Directive 73/23/EEC as attested by conformity with the following harmonized standard:**

- EN60950-1:2001
- EN60065:2002 (applied to models with TV function)

### **Council Decision 98/482/EC (CTR21) for pan-European single terminal connection to the Public Switched Telephone Network (PSTN).**

### **RoHS Directive 2002/95/EC on the Restriction of the Use of certain Hazardous Substances in Electrical and Electronic Equipment**



Acer Computer (Shanghai) Limited  
3F, No. 168 Xizang medium road, Huangpu District,  
Shanghai, China

R&TTE Directive 1999/5/EC as attested by conformity with the following harmonized standard:

● **Article 3.1(a) Health and Safety**

- EN60950-1:2001
- EN50371:2002

● **Article 3.1(b) EMC**

- EN301 489-1 V1.4.1:2002
- EN301 489-17 V1.2.1:2002
- EN301 489-3 V1.4.1:2002 (Applied to models with 27MHz wireless mouse/keyboard)
- EN301 489-7 V1.2.1:2002 (Applied to models with 3G function)
- EN301 489-24 V1.2.1:2002 (Applied to models with 3G function)

● **Article 3.2 Spectrum Usages**

- EN300 328 V1.5.1:2004
- EN301 893 V1.2.3:2003
- EN300 220-1 V1.3.1:2000 (Applied to models with 27MHz wireless mouse/keyboard)
- EN300 220-3 V1.1.1:2000 (Applied to models with 27MHz wireless mouse/keyboard)
- EN301 511 V9.0.2:2003 (Applied to models with 3G function)
- EN301 908-1 V2.2.1:2003 (Applied to models with 3G function).
- EN301 908-2 V2.2.1:2003 (Applied to models with 3G function).

*Easy Lai*

-----  
Easy Lai / Director  
Acer Computer (Shanghai) Limited



# Index

## A

- AC adapter
  - caring for x
- audio
  - troubleshooting 54

## B

- battery pack
  - caring for xi
- BIOS utility 46, 81
- brightness
  - hotkeys 33

## C

- caps lock 31
  - on indicator 27
- care
  - AC adapter x
  - battery pack xi
  - computer x
- CD-ROM
  - ejecting manually 54
  - troubleshooting 54
- cleaning
  - computer xi
- computer
  - caring for x
  - cleaning xi
  - disconnecting 71
  - features 15, 50
  - indicators 27
  - keyboards 31
  - moving around 71
  - on indicator 16, 27
  - security 75
  - setting up a home office 73
  - taking home 72
  - traveling internationally 74
  - traveling on local trips 73
  - troubleshooting 88
  - turning off x
- connections
  - network 78

## D

- display

- hotkeys 33
- troubleshooting 53

- DVD 83
- DVD movies
  - playing 83

## E

- error messages 88
- Euro 34

## F

- FAQ. See frequently-asked questions
- frequently-asked questions 53
- front view 16

## H

- Hibernation mode
  - hotkey 33
- hotkeys 32

## I

- IEEE 1394 port 79
- infrared 78

## K

- keyboard 31
  - embedded numeric keypad 31
  - hotkeys 32
  - lock keys 31
  - troubleshooting 54
  - Windows keys 32

## L

- left view 16

## M

- media access
  - on indicator 27
- memory
  - installing 80–81
- messages
  - error 88
- modem 77

## N

- network 78
- Notebook Manager
  - hotkey 33
- num lock 31
  - on indicator 27



- numeric keypad
  - embedded 31
- P
- password 75
  - types 75
- PC Card 80
  - ejecting 80
  - inserting 80
- ports 77
- printer
  - troubleshooting 54
- problems 53
  - CD-ROM 54
  - display 53
  - keyboard 54
  - printer 54
  - startup 53
  - troubleshooting 88
- Q
- questions
  - setting location for modem use 55
- S
- safety
  - CD or DVD 94
  - modem notices 91
- scroll lock 31
- security
  - keylock 35, 75
  - passwords 75
- speakers
  - hotkey 33
  - troubleshooting 54
- support
  - information 56
- T
- touchpad 29
  - hotkey 33
  - using 29–30
- travel
  - international flights 74
  - local trips 73
- troubleshooting 88
  - tips 88
- U
- universal serial bus 79
- V
- view
  - front 17
  - left 17
  - rear 19
  - right 18
- W
- Windows keys 32