

Aspire 4730Z/4330 Series

Quick Guide

Copyright © 2008. Acer Incorporated.
All Rights Reserved.

Aspire 4730Z/4330 Series Quick Guide
Original Issue: 07/2008

This company makes no representations or warranties, either express or implied, with respect to the contents hereof and specifically disclaims the implied warranties of merchantability or fitness for a particular purpose. Although care has been taken to ensure accuracy, this company shall not be liable for any errors (including, but not limited to, typos, factual errors, etc.) contained in this publication.

Changes may be made periodically to the information in this publication without obligation to notify any person of such revisions or changes. Such changes will be incorporated in new editions of this manual or supplementary documents and publications. This company makes no representations or warranties, either expressed or implied, with respect to the contents hereof and specifically disclaims the implied warranties of merchantability or fitness for a particular purpose.

Record the model number, serial number, purchase date and place of purchase information in the space provided below. The serial number and model number are recorded on the label affixed to your computer. All correspondence concerning your unit should include the serial number, model number and purchase information.

No part of this publication may be reproduced, stored in a retrieval system, or transmitted, in any form or by any means, electronically, mechanically, by photocopy, recording or otherwise, without the prior written permission of Acer Incorporated.

Aspire 4730Z/4330 Series Notebook PC

Model number: _____

Serial number: _____

Date of purchase: _____

Place of purchase: _____

Acer and the Acer logo are registered trademarks of Acer Incorporated. Other companies' product names or trademarks are used herein for identification purposes only and belong to their respective companies.

First things first

We would like to thank you for making an Acer notebook your choice for meeting your mobile computing needs.

Your guides

To help you use your Acer notebook, we have designed a set of guides*:

First off, the **Just for Starters...** helps you get started with setting up your computer.

For more on how your computer can help you to be more productive, please refer to the AcerSystem User Guide. This guide contains detailed information on such subjects as system utilities, data recovery, expansion options and troubleshooting. In addition it contains warranty information and the general regulations and safety notices for your notebook. It is available in Portable Document Format (PDF) and comes preloaded on your notebook. Information for your safety and comfort.



Note: Viewing the file requires Adobe Reader. If Adobe Reader is not installed on your computer, clicking on AcerSystem User Guide will run the Adobe Reader setup program first. Follow the instructions on the screen to complete the installation. For instructions on how to use Adobe Reader, access the Help and Support menu.

Please understand that due to its nature, the Quick Guide as well as the Application Manual will occasionally refer to functions or features which are only contained in certain models of the series, but not necessarily in the model you purchased. Such instances are marked in the text with language such as "only for certain models".







*** IMPORTANT NOTICE:** Please note that the guides mentioned herein, whether in printed or electronic form, are for your reference only and except as provided in the specific warranty information contained in the AcerSystem User Guide nothing contained in these guides shall constitute a representation or warranty by Acer with regard to the product you purchased. Acer expressly disclaims any liability for errors contained in the guides.

Your Acer notebook tour

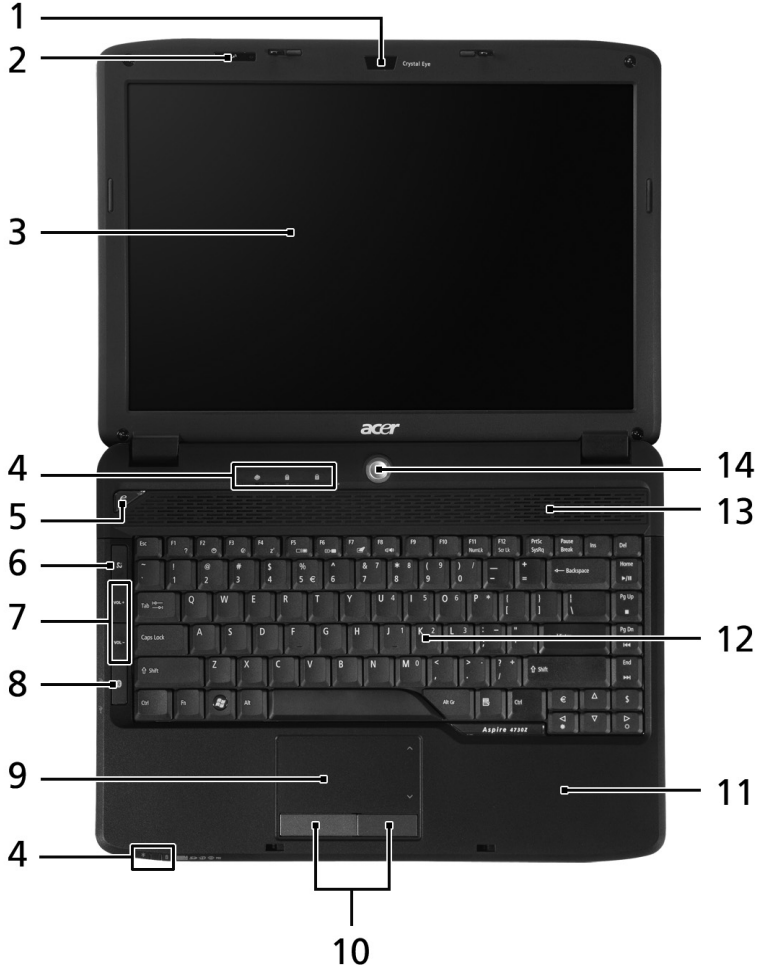
After setting up your computer as illustrated in the **Just for Starters...** poster, let us show you around your new Acer notebook.

Top view



#	Icon	Item	Description
1		Acer Crystal Eye	Web camera for video communication.
2		Microphone	Internal microphone for sound recording.
3		Display screen	Also called Liquid-Crystal Display (LCD), displays computer output.
4		Status indicators	Light-Emitting Diodes (LEDs) that light up to show the status of the computer's functions and components. Please refer to "Generic User Guide" for more details.
5		Empowering key	Lanuch Acer Empowering Technology.
6		Wireless communication button	Enables/disables the wireless function.
7	VOL+/ VOL-	Volume Up/ Volume Down	Increase system volume/decrease system volume.
8		Bluetooth communication button	Enables/disables the Bluetooth function.
9		Touchpad	Touch-sensitive pointing device which functions like a computer mouse.
10		Click buttons (left and right)	The left and right buttons function like the left and right mouse buttons.
11		Palmrest	Comfortable support area for your hands when you use the computer.
12		Keyboard	For entering data into your computer.
13		Speakers	Left and right speakers deliver stereo audio output.
14		Power button	Turns the computer on and off.







Closed front view

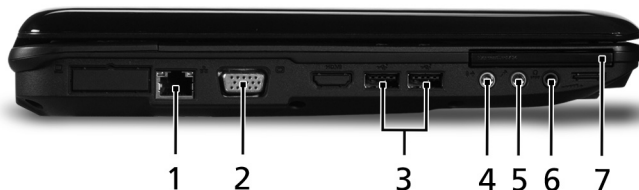

#	Icon	Item	Description
1		5-in-1 card reader	Accepts Secure Digital (SD), MultiMediaCard (MMC), Memory Stick (MS), Memory Stick PRO (MS PRO), xD-Picture Card (xD). Note: Push to remove/install the card. Only one card can operate at any given time
2		Latch	Locks and releases the lid.



Left view

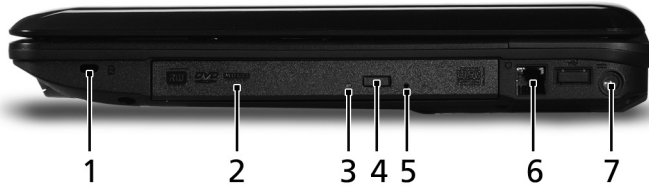

#	Icon	Item	Description
1		Ethernet (RJ-45) port	Connects to an Ethernet 10/100/1000-based network.
2		External display (VGA) port	Connects to a display device (e.g., external monitor, LCD projector).
3		2 USB 2.0 ports	Connect to USB 2.0 devices (e.g., USB mouse, USB camera).
4		Line-in jack	Accepts audio line-in devices (e.g., audio CD player, stereo walkman).
5		Microphone-in jack	Accepts input from external microphones.
6		Headphones/speaker/line-out	Connects to audio line-out devices (e.g., speakers, headphones).
7		ExpressCard/54 slot	Accepts one ExpressCard/54 module.

Right view



#	Icon	Item	Description
1		Kensington lock slot	Connects to a Kensington-compatible computer security lock.
2		Optical drive	Internal optical drive; accepts CDs or DVDs.
3		Optical disk access indicator	Lights up when the optical drive is active.
4		Optical drive eject button	Ejects the optical disk from the drive.
5		Emergency eject hole	Ejects the optical drive tray when the computer is turned off. Note: Insert a paper clip to the emergency eject hole to eject the optical drive tray when the computer is off.
6		Modem (RJ-11) port	Connects to a phone line.
7		DC-in jack	Connects to an AC adapter.





Rear view

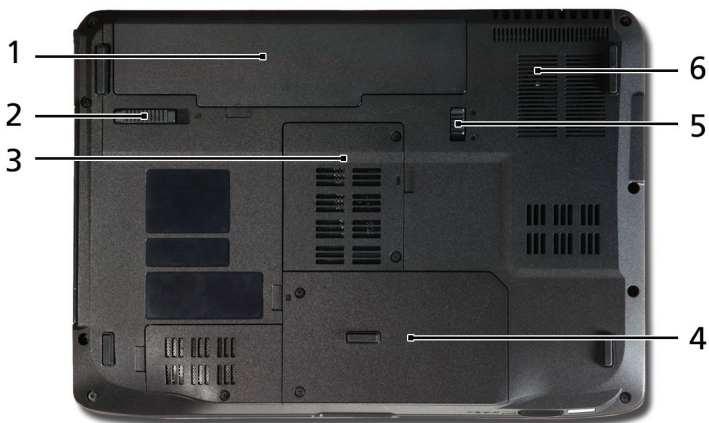

#	Icon	Item	Description
1		Ventilation slots	Enable the computer to stay cool, even after prolonged use.

Base view



#	Icon	Item	Description
1		Battery bay	Houses the computer's battery pack.
2		Battery release latch	Releases the battery for removal.
3		Memory compartment	Houses the computer's main memory.
4		Hard disk bay	Houses the computer's hard disk (secured with screws).
5		Battery lock	Locks the battery in position.
6		Ventilation slots and cooling fan	Enable the computer to stay cool, even after prolonged use. Note: Do not cover or obstruct the opening of the fan.

Specifications

Operating system	<ul style="list-style-type: none"> Genuine Windows Vista™
Platform	<ul style="list-style-type: none"> Intel® Pentium® Dual-Core mobile processor* Intel® Celeron® Dual-Core processor* Intel® Celeron® processor* Mobile Intel® PM45 Express Chipset* Mobile Intel® GL40 Express Chipset* Acer InviLink™ Nplify™ 802.11b/g/Draft-N* Acer InviLink™ 802.11b/g*
System memory	<ul style="list-style-type: none"> Dual-Channel DDR2 SDRAM support Up to 2 GB of DDR2 667 MHz memory, upgradeable to 4 GB using two soDIMM modules*
Display	<ul style="list-style-type: none"> 14.1" WXGA 1280 x 800
Graphics	<ul style="list-style-type: none"> Mobile Intel® GL40 Express Chipset* ATI Mobility Radeon™ HD 3470*
Storage subsystem	<ul style="list-style-type: none"> 2.5" hard disk drive Optical drive options: <ul style="list-style-type: none"> DVD-Super Multi double-layer drive* DVD/CD-RW combo drive* 5-in-1 card reader
Dimensions	<ul style="list-style-type: none"> 340.4 (W) x 247 (D) x 22.9/42.3 (H) mm (13.4 x 9.7 x 0.9/1.6 inches) 2.4 kg (5.29 lbs)
Audio	<ul style="list-style-type: none"> Two built-in stereo speakers High-definition audio support MS-Sound compatible Built-in microphone
Communication	<ul style="list-style-type: none"> Acer Video Conference, featuring: <ul style="list-style-type: none"> Integrated Acer Crystal Eye webcam Optional Acer Xpress VoIP phone WLAN: <ul style="list-style-type: none"> Acer InviLink™ Nplify™ 802.11b/g/Draft-N* Acer InviLink™ 802.11b/g* WPAN: Bluetooth® 2.0+EDR LAN: Gigabit Ethernet, Wake-on-LAN ready Modem: 56K ITU V.92
Privacy control	<ul style="list-style-type: none"> BIOS user, supervisor, HDD passwords Kensington lock slot

Power subsystem	<ul style="list-style-type: none"> • ACPI 3.0 • 48.8 W 4400 mAh • 3-pin 65 W AC adapter* • 3-pin 90 W AC adapter* • Energy Star 4.0
Special keys and controls	<ul style="list-style-type: none"> • 88-/89-/93-key keyboard • Touchpad pointing device • Empowering Key • Easy-launch buttons: WLAN, volume up and down and Bluetooth®
I/O interface	<ul style="list-style-type: none"> • ExpressCard™/54 slot • 5-in-1 card reader (SD™, MMC, MS, MS PRO, xD) • Two USB 2.0 ports • External display (VGA) port • Headphone/speaker/line-out jack • Microphone-in jack • Line-in jack • Ethernet (RJ-45) port • Modem (RJ-11) port • DC-in jack for AC adapter
Environment	<ul style="list-style-type: none"> • Temperature: <ul style="list-style-type: none"> • Operating: 5 °C to 35 °C • Non-operating: -20 °C to 65 °C • Humidity (non-condensing): <ul style="list-style-type: none"> • Operating: 20% to 80% • Non-operating: 20% to 80%



Note: * only for certain models.



Note: The specifications listed above are for reference only. The exact configuration of your PC depends on the model purchased.