

**Aspire
5520/5220
Series**

User's Guide

Copyright © 2007. Acer Incorporated.
All Rights Reserved.

Aspire 5520/5220 Series User's Guide
Original Issue: 05/2007

Changes may be made periodically to the information in this publication without obligation to notify any person of such revisions or changes. Such changes will be incorporated in new editions of this manual or supplementary documents and publications. This company makes no representations or warranties, either expressed or implied, with respect to the contents hereof and specifically disclaims the implied warranties of merchantability or fitness for a particular purpose.

Record the model number, serial number, purchase date and place of purchase information in the space provided below. The serial number and model number are recorded on the label affixed to your computer. All correspondence concerning your unit should include the serial number, model number and purchase information.

No part of this publication may be reproduced, stored in a retrieval system, or transmitted, in any form or by any means, electronically, mechanically, by photocopy, recording or otherwise, without the prior written permission of Acer Incorporated.

Aspire 5520/5220 Series Notebook PC

Model number: _____

Serial number: _____

Date of purchase: _____

Place of purchase: _____

Acer and the Acer logo are registered trademarks of Acer Incorporated. Other companies' product names or trademarks are used herein for identification purposes only and belong to their respective companies.

Information for your safety and comfort

Safety instructions

Read these instructions carefully. Keep this document for future reference. Follow all warnings and instructions marked on the product.

Turning the product off before cleaning

Unplug this product from the wall outlet before cleaning. Do not use liquid cleaners or aerosol cleaners. Use a damp cloth for cleaning.

CAUTION for plug as disconnecting device

Observe the following guidelines when connecting and disconnecting power to the power supply unit:

Install the power supply unit before connecting the power cord to the AC power outlet.

Unplug the power cord before removing the power supply unit from the computer.

If the system has multiple sources of power, disconnect power from the system by unplugging all power cords from the power supplies.

CAUTION for Accessibility

Be sure that the power outlet you plug the power cord into is easily accessible and located as close to the equipment operator as possible. When you need to disconnect power to the equipment, be sure to unplug the power cord from the electrical outlet.

CAUTION for Dummy Card of PCMCIA & Express Slot

Your computer shipped with plastic dummies installed in the PCMCIA & Express slot. Dummies protect unused slots from dust, metal object, or other particles. Save the dummy for use when no PCMCIA or Express Card is installed in the slot.

CAUTION for Listening

To protect your hearing, follow these instructions.

- Increase the volume gradually until you can hear clearly and comfortably.
- Do not increase the volume level after your ears have adjusted.
- Do not listen to music at high volumes for extended periods.
- Do not increase the volume to block out noisy surroundings.
- Decrease the volume if you can't hear people speaking near you.

Warnings

- Do not use this product near water.
- Do not place this product on an unstable cart, stand or table. If the product falls, it could be seriously damaged.
- Slots and openings are provided for ventilation to ensure reliable operation of the product and to protect it from overheating. These openings must not be blocked or covered. The openings should never be blocked by placing the product on a bed, sofa, rug or other similar surface. This product should never be placed near or over a radiator or heat register, or in a built-in installation unless proper ventilation is provided.
- Never push objects of any kind into this product through cabinet slots as they may touch dangerous voltage points or short-out parts that could result in a fire or electric shock. Never spill liquid of any kind onto or into the product.
- To avoid damage of internal components and to prevent battery leakage, do not place the product on a vibrating surface.
- Never use it under sporting, exercising, or any vibrating environment which will probably cause unexpected short current or damage rotor devices, HDD, Optical drive, and even exposure risk from lithium battery pack.

Using electrical power

- This product should be operated from the type of power indicated on the marking label. If you are not sure of the type of power available, consult your dealer or local power company.
- Do not allow anything to rest on the power cord. Do not locate this product where people will walk on the cord.
- If an extension cord is used with this product, make sure that the total ampere rating of the equipment plugged into the extension cord does not exceed the extension cord ampere rating. Also, make sure that the total rating of all products plugged into the wall outlet does not exceed the fuse rating.
- Do not overload a power outlet, strip or receptacle by plugging in too many devices. The overall system load must not exceed 80% of the branch circuit rating. If power strips are used, the load should not exceed 80% of the power strip's input rating.
- This product's AC adapter is equipped with a three-wire grounded plug. The plug only fits in a grounded power outlet. Make sure the power outlet is properly grounded before inserting the AC adapter plug. Do not insert the plug into a non-grounded power outlet. Contact your electrician for details.



.....
Warning! The grounding pin is a safety feature. Using a power outlet that is not properly grounded may result in electric shock and/or injury.



.....

Note: The grounding pin also provides good protection from unexpected noise produced by other nearby electrical devices that may interfere with the performance of this product.

- Use the product only with the supplied power supply cord set. If you need to replace the power cord set, make sure that the new power cord meets the following requirements: detachable type, UL listed/CSA certified, type SPT-2, rated 7 A 125 V minimum, VDE approved or its equivalent, 4.6 meters (15 feet) maximum length.

Product servicing

Do not attempt to service this product yourself, as opening or removing covers may expose you to dangerous voltage points or other risks. Refer all servicing to qualified service personnel.

Unplug this product from the wall outlet and refer servicing to qualified service personnel when:

- the power cord or plug is damaged, cut or frayed
- liquid was spilled into the product
- the product was exposed to rain or water
- the product has been dropped or the case has been damaged
- the product exhibits a distinct change in performance, indicating a need for service
- the product does not operate normally after following the operating instructions



.....

Note: Adjust only those controls that are covered by the operating instructions, since improper adjustment of other controls may result in damage and will often require extensive work by a qualified technician to restore the product to normal condition.

Guidelines for safe battery usage

This notebook uses a Lithium-ion battery. Do not use it in a humid, wet or corrosive environment. Do not put, store or leave your product in or near a heat source, in a high temperature location, in strong direct sunlight, in a microwave oven or in a pressurized container, and do not expose it to temperatures over 60°C (140°F). Failure to follow these guidelines may cause the battery to leak acid, become hot, explode or ignite and cause injury and/or damage. Do not pierce, open or disassemble the battery. If the battery leaks and you come into contact with the leaked fluids, rinse thoroughly with water and seek medical attention immediately. For safety reasons, and to prolong the lifetime of the battery, charging will not occur at temperatures below 0°C (32°F) or above 40°C (104°F).

The full performance of a new battery is achieved only after two or three complete charge and discharge cycles. The battery can be charged and

discharged hundreds of times, but it will eventually wear out. When the operation time becomes noticeably shorter than normal, buy a new battery. Use only Acer approved batteries, and recharge your battery only with Acer approved chargers designated for this device.

Use the battery only for its intended purpose. Never use any charger or battery that is damaged. Do not short-circuit the battery. Accidental short-circuiting can occur when a metallic object such as a coin, clip or pen causes direct connection of the positive (+) and negative (-) terminals of the battery. (These look like metal strips on the battery.) This might happen, for example, when you carry a spare battery in your pocket or purse. Short-circuiting the terminals may damage the battery or the connecting object.

The capacity and lifetime of the battery will be reduced if the battery is left in hot or cold places, such as in a closed car in summer or winter. Always try to keep the battery between 15°C and 25°C (59°F and 77°F). A device with a hot or cold battery may not work temporarily, even when the battery is fully charged. Battery performance is especially limited in temperatures well below freezing.

Do not dispose of batteries in a fire as they may explode. Batteries may also explode if damaged. Dispose of batteries according to local regulations. Please recycle when possible. Do not dispose as household waste.

Wireless devices may be susceptible to interference from the battery, which could affect performance.

Potentially explosive environments

Switch off your device in any area with a potentially explosive atmosphere and obey all signs and instructions. Potentially explosive atmospheres include areas where you would normally be advised to turn off your vehicle engine. Sparks in such areas could cause an explosion or fire resulting in bodily injury or even death. Switch off the notebook near gas pumps at service stations. Observe restrictions on the use of radio equipment in fuel depots, storage and distribution areas; chemical plants; or where blasting operations are in progress. Areas with a potentially explosive atmosphere are often, but not always, marked. They include below deck on boats, chemical transfer or storage facilities, vehicles using liquefied petroleum gas (such as propane or butane), and areas where the air contains chemicals or particles such as grain, dust or metal powders. Do not switch the notebook on when wireless phone use is prohibited or when it may cause interference or danger.

Replacing the battery pack

The notebook uses lithium batteries. Replace the battery with the same type as that which came bundled with your product. Use of another battery may present a risk of fire or explosion.



Warning! Batteries may explode if not handled properly. Do not disassemble or dispose of them in fire. Keep them away from children. Follow local regulations when disposing of used batteries.

Telephone line safety

- Disconnect all telephone lines from the equipment when not in use and/or before servicing.
- To avoid the remote risk of electric shock from lightning, do not connect the telephone line to this equipment during lightning or thunderstorms.



Warning! For safety reasons, do not use non-compliant parts when adding or changing components. Consult your reseller for purchase options.

Additional safety information

Your device and its enhancements may contain small parts. Keep them out of the reach of small children.

Operating environment



Warning! For safety reasons, turn off all wireless or radio transmitting devices when using your laptop under the following conditions. These devices may include, but are not limited to: wireless lan (WLAN), Bluetooth and/or 3G.

Remember to follow any special regulations in force in any area, and always switch off your device when its use is prohibited or when it may cause interference or danger. Use the device only in its normal operating positions. This device meets RF exposure guidelines when used normally, and it and its antenna are positioned at least 1.5 centimeters (5/8 inches) away from your body (refer to the figure below). It should not contain metal and you should position the device the above-stated distance from your body. To successfully transmit data files or messages, this device requires a good quality connection to the network. In some cases, transmission of data files or messages may be delayed until such a connection is available. Ensure that the above separation distance instructions are followed until the transmission is completed. Parts of the device are magnetic. Metallic materials may be attracted to the device, and persons with hearing aids should not hold the device to the ear with the hearing aid. Do not place credit cards or other magnetic storage media near the device, because information stored on them may be erased.

Medical devices

Operation of any radio transmitting equipment, including wireless phones, may interfere with the functionality of inadequately protected medical devices. Consult a physician or the manufacturer of the medical device to determine if they are adequately shielded from external RF energy or if you have any questions. Switch off your device in health care facilities when any regulations posted in these areas instruct you to do so. Hospitals or health care facilities may be using equipment that could be sensitive to external RF transmissions..

Pacemakers. Pacemaker manufacturers recommend that a minimum separation of 15.3 centimeters (6 inches) be maintained between wireless devices and a pacemaker to avoid potential interference with the pacemaker. These recommendations are consistent with the independent research by and recommendations of Wireless Technology Research. Persons with pacemakers should do the following:

- Always keep the device more than 15.3 centimeters (6 inches) from the pacemaker
- Not carry the device near your pacemaker when the device is switched o. If you suspect interference, switch off your device, and move it.

Hearing aids. Some digital wireless devices may interfere with some hearing aids. If interference occurs, consult your service provider.

Vehicles

RF signals may affect improperly installed or inadequately shielded electronic systems in motor vehicles such as electronic fuel injection systems, electronic antiskid (antilock) braking systems, electronic speed control systems, and air bag systems. For more information, check with the manufacturer, or its representative, of your vehicle or any equipment that has been added. Only qualified personnel should service the device, or install the device in a vehicle. Faulty installation or service may be dangerous and may invalidate any warranty that may apply to the device. Check regularly that all wireless equipment in your vehicle is mounted and operating properly. Do not store or carry flammable liquids, gases, or explosive materials in the same compartment as the device, its parts, or enhancements. For vehicles equipped with an air bag, remember that air bags inflate with great force. Do not place objects, including installed or portable wireless equipment in the area over the air bag or in the air bag deployment area. If in-vehicle wireless equipment is improperly installed, and the air bag inflates, serious injury could result. Using your device while flying in aircraft is prohibited. Switch off your device before boarding an aircraft. The use of wireless teledevices in an aircraft may be dangerous to the operation of the aircraft, disrupt the wireless telephone network, and may be illegal.

Potentially explosive environments

Switch off your device when in any area with a potentially explosive atmosphere and obey all signs and instructions. Potentially explosive atmospheres include areas where you would normally be advised to turn off your vehicle engine. Sparks in such areas could cause an explosion or fire resulting in bodily injury or even death. Switch off the device at refueling points such as near gas pumps at service stations. Observe restrictions on the use of radio equipment in fuel depots, storage, and distribution areas; chemical plants; or where blasting operations are in progress. Areas with a potentially explosive atmosphere are often, but not always, clearly marked. They include below deck on boats, chemical transfer or storage facilities, vehicles using liquefied petroleum gas (such as propane or butane), and areas where the air contains chemicals or particles such as grain, dust or metal powders.

Emergency calls

Warning: You cannot make emergency calls through this device. To make an emergency call you shall dial out through your mobile phone or other telephone call system.

Disposal instructions

Do not throw this electronic device into the trash when discarding. To minimize pollution and ensure utmost protection of the global environment, please recycle. For more information on the Waste from Electrical and Electronics Equipment (WEEE) regulations, visit <http://global.acer.com/about/sustainability.htm>



Mercury advisory

For projectors or electronic products containing an LCD/CRT monitor or display: Lamp(s) inside this product contain mercury and must be recycled or disposed of according to local, state or federal laws. For more information, contact the Electronic Industries Alliance at www.eiae.org. For lamp-specific disposal information, check www.lamprecycle.org.





ENERGY STAR is a government program (public/private partnership) that gives people the power to protect the environment in a cost effective way and without sacrificing quality or product features. Products that earn the ENERGY STAR prevent greenhouse gas emissions by meeting strict energy efficiency guidelines set by the US Environmental Protection Agency (EPA) and the US Department of Energy (DOE). In the average home, 75% of all electricity used to power home electronics is consumed while the products are turned off. ENERGY STAR qualified home electronic products in the off position use up to 50% less energy than conventional equipment. More information refers to <http://www.energystar.gov> and <http://www.energystar.gov/powermanagement>.

As an ENERGY STAR partner, Acer Inc. has determined that this product meets the ENERGY STAR guidelines for energy efficiency.

This product has been shipped enabled for power management:

- Activate display' Sleep mode within 15 minutes of user inactivity.
- Activate computer's Sleep mode within 30 minutes of user inactivity.
- Wake the computer from Sleep mode by pushing power button.
- More power management settings can be done through Acer ePower Management.

Tips and information for comfortable use

Computer users may complain of eyestrain and headaches after prolonged use. Users are also at risk of physical injury after long hours of working in front of a computer. Long work periods, bad posture, poor work habits, stress, inadequate working conditions, personal health and other factors greatly increase the risk of physical injury.

Incorrect computer usage may lead to carpal tunnel syndrome, tendonitis, tenosynovitis or other musculoskeletal disorders. The following symptoms may appear in the hands, wrists, arms, shoulders, neck or back:

- numbness, or a burning or tingling sensation
- aching, soreness or tenderness
- pain, swelling or throbbing
- stiffness or tightness
- coldness or weakness

If you have these symptoms, or any other recurring or persistent discomfort and/or pain related to computer use, consult a physician immediately and inform your company's health and safety department.

The following section provides tips for more comfortable computer use.

Finding your comfort zone

Find your comfort zone by adjusting the viewing angle of the monitor, using a footrest, or raising your sitting height to achieve maximum comfort. Observe the following tips:

- refrain from staying too long in one fixed posture
- avoid slouching forward and/or leaning backward
- stand up and walk around regularly to remove the strain on your leg muscles
- take short rests to relax your neck and shoulders
- avoid tensing your muscles or shrugging your shoulders
- install the external display, keyboard and mouse properly and within comfortable reach
- if you view your monitor more than your documents, place the display at the center of your desk to minimize neck strain

Taking care of your vision

Long viewing hours, wearing incorrect glasses or contact lenses, glare, excessive room lighting, poorly focused screens, very small typefaces and low-contrast displays could stress your eyes. The following sections provide suggestions on how to reduce eyestrain.

Eyes

- Rest your eyes frequently.
- Give your eyes regular breaks by looking away from the monitor and focusing on a distant point.
- Blink frequently to keep your eyes from drying out.

Display

- Keep your display clean.
- Keep your head at a higher level than the top edge of the display so your eyes point downward when looking at the middle of the display.
- Adjust the display brightness and/or contrast to a comfortable level for enhanced text readability and graphics clarity.
- Eliminate glare and reflections by:
 - placing your display in such a way that the side faces the window or any light source
 - minimizing room light by using drapes, shades or blinds
 - using a task light
 - changing the display's viewing angle
 - using a glare-reduction filter
 - using a display visor, such as a piece of cardboard extended from the display's top front edge
- Avoid adjusting your display to an awkward viewing angle.
- Avoid looking at bright light sources, such as open windows, for extended periods of time.

Developing good work habits

Develop the following work habits to make your computer use more relaxing and productive:

- Take short breaks regularly and often.
- Perform some stretching exercises.
- Breathe fresh air as often as possible.
- Exercise regularly and maintain a healthy body.



.....
Warning! We do not recommend using the computer on a couch or bed. If this is unavoidable, work for only short periods, take breaks regularly, and do some stretching exercises.



.....
Note: For more information, please refer to "**Regulations and safety notices**" on page 86 in the **AcerSystem User's Guide**.

First things first

We would like to thank you for making an Acer notebook your choice for meeting your mobile computing needs.

Your guides

To help you use your Acer notebook, we have designed a set of guides:



First off, the **Just for Starters...** poster helps you get started with setting up your computer.



The printed **User's Guide** introduces you to the basic features and functions of your new computer. For more on how your computer can help you to be more productive, please refer to the **AcerSystem User's Guide**. This guide contains detailed information on such subjects as system utilities, data recovery, expansion options and troubleshooting. In addition it contains warranty information and the general regulations and safety notices for your notebook. It is available in Portable Document Format (PDF) and comes preloaded on your notebook. Follow these steps to access it:

- 1 Click on  **Start, All Programs, AcerSystem.**
- 2 Click on **AcerSystem User's Guide.**

Note: Viewing the file requires Adobe Reader. If Adobe Reader is not installed on your computer, clicking on **AcerSystem User's Guide** will run the Adobe Reader setup program first. Follow the instructions on the screen to complete the installation. For instructions on how to use Adobe Reader, access the **Help and Support** menu.

Basic care and tips for using your computer

Turning your computer on and off

To turn on the computer, simply press and release the power button below the LCD screen beside the easy-launch buttons. See **"Top view" on page 15** for the location of the power button.

To turn the power off, do any of the following:

- Use the Windows shutdown command Click on **Start**  then click on **Shut Down**.
- Use the power button

You can also put the computer in sleep mode by pressing the sleep hotkey **<Fn> + <F4>**.



.....

Note: If you cannot power off the computer normally, press and hold the power button for more than four seconds to shut down the computer. If you turn off the computer and want to turn it on again, wait at least two seconds before powering up.

Taking care of your computer

Your computer will serve you well if you take care of it.

- Do not expose the computer to direct sunlight. Do not place it near sources of heat, such as a radiator.
- Do not expose the computer to temperatures below 0 °C (32 °F) or above 50 °C (122 °F).
- Do not subject the computer to magnetic fields.
- Do not expose the computer to rain or moisture.
- Do not spill water or any liquid on the computer.
- Do not subject the computer to heavy shock or vibration.
- Do not expose the computer to dust or dirt.
- Never place objects on top of the computer.
- Do not slam the computer display when you close it.
- Never place the computer on uneven surfaces.

Taking care of your AC adapter

Here are some ways to take care of your AC adapter:

- Do not connect the adapter to any other device.
- Do not step on the power cord or place heavy objects on top of it. Carefully route the power cord and any cables away from foot traffic.
- When unplugging the power cord, do not pull on the cord itself but pull on the plug.
- The total ampere ratings of the equipment plugged in should not exceed the ampere rating of the cord if you are using an extension cord. Also, the total current rating of all equipment plugged into a single wall outlet should not exceed the fuse rating.

Taking care of your battery pack

Here are some ways to take care of your battery pack:

- Use only batteries of the same kind as replacements. Turn the power off before removing or replacing batteries.
- Do not tamper with batteries. Keep them away from children.
- Dispose of used batteries according to local regulations. Recycle if possible.

Cleaning and servicing

When cleaning the computer, follow these steps:

- 1 Turn off the computer and remove the battery pack.
- 2 Disconnect the AC adapter.
- 3 Use a soft, moist cloth. Do not use liquid or aerosol cleaners.

If either of the following occurs:

- the computer has been dropped or the body has been damaged;
- the computer does not operate normally

please refer to **"Frequently asked questions" on page 40**.

Information for your safety and comfort	iii
Safety instructions	iii
Additional safety information	vii
Operating environment	vii
Medical devices	vii
Vehicles	viii
Potentially explosive environments	viii
Emergency calls	ix
Disposal instructions	ix
Tips and information for comfortable use	x
First things first	xiii
Your guides	xiii
Basic care and tips for using your computer	xiii
Turning your computer on and off	xiii
Taking care of your computer	xiv
Taking care of your AC adapter	xiv
Taking care of your battery pack	xv
Cleaning and servicing	xv
Acer Empowering Technology	1
Empowering Technology password	1
Acer eNet Management	2
Acer ePower Management	4
Acer eAudio Management	6
Acer ePresentation Management	7
Acer eDataSecurity Management	8
Acer eLock Management	9
Acer eRecovery Management	11
Acer eSettings Management	13
Windows Mobility Center	14
Your Acer notebook tour	15
Top view	15
Closed front view	17
Left view	18
Right view	19
Rear view	19
Base view	20
Specifications	21
Indicators	25
Easy-launch buttons	26
Touchpad	27
Touchpad basics	27
Using the keyboard	29
Lock keys and embedded numeric keypad	29
Windows keys	30
Hotkeys	31

Contents

Special keys	32
Ejecting the optical (CD or DVD) drive tray	33
Using a computer security lock	33
Audio	34
Adjusting the volume	34
Using Dolby Home Theater for surround/multi-channel sound	35
Set playback as digital output	35
Using the system utilities	37
Acer GridVista (dual-display compatible)	37
Launch Manager	38
Frequently asked questions	40
Requesting service	43
International Travelers Warranty (ITW)	43
Before you call	43
Battery pack	44
Battery pack characteristics	44
Maximizing the battery's life	44
Installing and removing the battery pack	45
Charging the battery	46
Checking the battery level	46
Optimising battery life	46
Battery-low warning	47
Acer Arcade (for selected models)	48
Finding and playing content	49
Settings	49
Arcade controls	50
Navigation controls	50
Player controls	50
Virtual keyboard	51
Background mode	51
Cinema	52
Settings	52
Album	53
Editing Pictures	53
Slide Show settings	53
Video	54
Playing a video file	54
Capturing video (TV models only)	54
Snapshot	54
Music	55
TV (for selected models)	56
Time-shift functionality	56
Recorded TV	57

Scheduling recordings	57
Program guide	57
Find program	57
TV settings	57
Using TeleText functions	58
Acer Arcade Deluxe	
(for selected models)	60
	60
Remote control (for selected models)	61
Remote functions	62
Starting Acer Arcade Deluxe	63
VideoMagician	63
TV Joy (selected models only)	63
SportsCap (selected models only)	63
DV Wizard	64
DVDivine	64
Taking your notebook PC with you	65
	65
Disconnecting from the desktop	65
Moving around	65
Preparing the computer	65
What to bring to meetings	66
Taking the computer home	66
Preparing the computer	66
What to take with you	66
Special considerations	67
Setting up a home office	67
Traveling with the computer	67
Preparing the computer	67
What to take with you	67
Special considerations	68
Traveling internationally with the computer	68
Preparing the computer	68
What to bring with you	68
Special considerations	68
Securing your computer	69
	69
Using a computer security lock	69
Using passwords	70
Entering passwords	70
Setting passwords	70
Expanding through options	71
	71
Connectivity options	71
Fax/data modem	71
Built-in network feature	72
Universal Serial Bus (USB)	72
IEEE 1394 port	73
ExpressCard	74

Installing memory	75
Connecting your TV and AV-in cables (for selected models)	76
BIOS utility	79
Boot sequence	79
Enable disk-to-disk recovery	79
Password	79
Using software	80
Playing DVD movies	80
Power management	81
Acer eRecovery Management	82
Create backup	82
Burn backup disc	83
Restore and recovery	83
Troubleshooting	84
Troubleshooting tips	84
Error messages	84
Regulations and safety notices	86
FCC notice	86
Modem notices	87
Laser compliance statement	90
LCD pixel statement	90
Macrovision copyright protection notice	90
Radio device regulatory notice	91
General	91
European Union (EU)	91
The FCC RF safety requirement	93
Canada — Low-power license-exempt radio communication devices (RSS-210)	94
Federal Communications Commission Declaration of Conformity	95
LCD panel ergonomic specifications	97
Index	98

Acer Empowering Technology

The Empowering Technology toolbar makes it easy for you to access frequently used functions and manage your new Acer system. Displayed by default in the upper half of your screen, it provides access to the following utilities:



.....

Note: All of the following content is for general reference only. Actual product specifications may vary.

- **Acer eNet Management** hooks up to location-based networks intelligently.
- **Acer ePower Management** optimizes battery usage via customizable power plans.
- **Acer eAudio Management** allows you to easily control the enhanced sound effects of Dolby® Home Theater™ on your system.
- **Acer ePresentation Management** connects to a projector and adjusts display settings.
- **Acer eDataSecurity Management** protects data with passwords and encryption. (for selected models)
- **Acer eLock Management** limits access to external storage media.
- **Acer eRecovery Management** backs up and recovers data flexibly, reliably and completely.
- **Acer eSettings Management** accesses system information and adjusts settings easily.



For more information, right click on the Empowering Technology toolbar, then select the **"Help"** or **"Tutorial"** function.

Empowering Technology password

Before using Acer eLock Management and Acer eRecovery Management, you must initialize the Empowering Technology password. Right-click on the Empowering Technology toolbar and select **"Password Setup"** to do so. If you have not initialized the Empowering Technology password and run Acer eLock Management or Acer eRecovery Management, you will be asked to create it.



.....

Note: If you lose the Empowering Technology password, there is no way to reset it except by reformatting your system. Make sure to remember or write down your password!

Acer eNet Management

Acer eNet Management helps you quickly connect to both wired and wireless networks in a variety of locations. To access this utility, select **"Acer eNet Management"** from the Empowering Technology toolbar or run the program from the Acer Empowering Technology program group in Start menu. You can also set Acer eNet Management to start automatically when you boot up your PC.

Acer eNet Management automatically detects the best settings for a new location, while offering you the option to manually adjust the settings to match your needs.



Acer eNet Management can save network settings for a location to a profile, and automatically switch to the appropriate profile when you move from one location to another. Settings stored include network connection settings (IP and DNS settings, wireless AP details, etc.), as well as default printer settings. Security and safety concerns mean that Acer eNet Management does not store username and password information.



Acer ePower Management

Acer ePower Management features a straightforward user interface for configuring your power management options. To access this utility, select "**Acer ePower Management**" from the Empowering Technology toolbar, run the program from the Acer Empowering Technology program group in Start menu, or right-click the Windows power icon in the system tray and select "**Acer ePower Management**".

Using power plans

Acer ePower Management comes with three predefined power plans: Balanced, High performance and Power saver. You can also create customized power plans. You can create, switch between, edit, delete and restore power plans, as described below.

View and adjust settings for On Battery and Plugged In modes by clicking the appropriate tabs. You can open Windows power options by clicking "**More Power Options**".



Note: You cannot delete the predefined power plans.

To create a new power plan:

Creating customized power plans allows you to save and quickly switch to a personalized set of power options.

- 1 Click the Create Power Plan icon. 
- 2 Enter a name for your new power plan.
- 3 Choose a predefined power plan to base your customized plan on.
- 4 If necessary, change the display and sleep settings you want your computer to use.
- 5 Click "**OK**" to save your new power plan.

To switch between power plans:

- 1 Select the power plan you wish to switch to from the drop-down list.
- 2 Click "**Apply**".

To edit a power plan:

Editing a power plan allows you to adjust system settings like LCD brightness and CPU speed. You can also turn on/off system components to extend battery life.

- 1 Switch to the power plan you wish to edit
- 2 Adjust settings as required.

- 3 Click **"Apply"** to save your new settings.

To delete a power plan:

You cannot delete the power plan you are currently using. If you want to delete the active power plan, switch to another one first.

- 1 Select the power plan you wish to delete from the drop-down list.
- 2 Click the Delete Power Plan icon. 

Battery status

For real-time battery life estimates based on current usage, refer to the panel in the upper half of the window. Click the  to view estimated battery life in sleep and hibernate modes.



Acer eAudio Management

Acer eAudio Management allows you to easily control the enhanced sound effects of Dolby® Home Theater™ on your system. Select **"Movie"** or **"Game"** mode to experience the awesome realism of 5.1-channel surround sound from just 2 speakers, via Dolby Virtual Speaker technology. **"Music"** mode lets you enjoy your favorite tunes, in vivid detail..



Surround On



Surround On



Surround Off

Acer ePresentation Management

Acer ePresentation Management lets you project your computer's display to an external display device or projector using the hotkey: **<Fn> + <F5>**. If auto-detection hardware is implemented in the system and the external display supports it, your system display will be automatically switched out when an external display is connected to the system. For projectors and external devices that are not auto-detected, launch Acer ePresentation Management to choose an appropriate display setting.

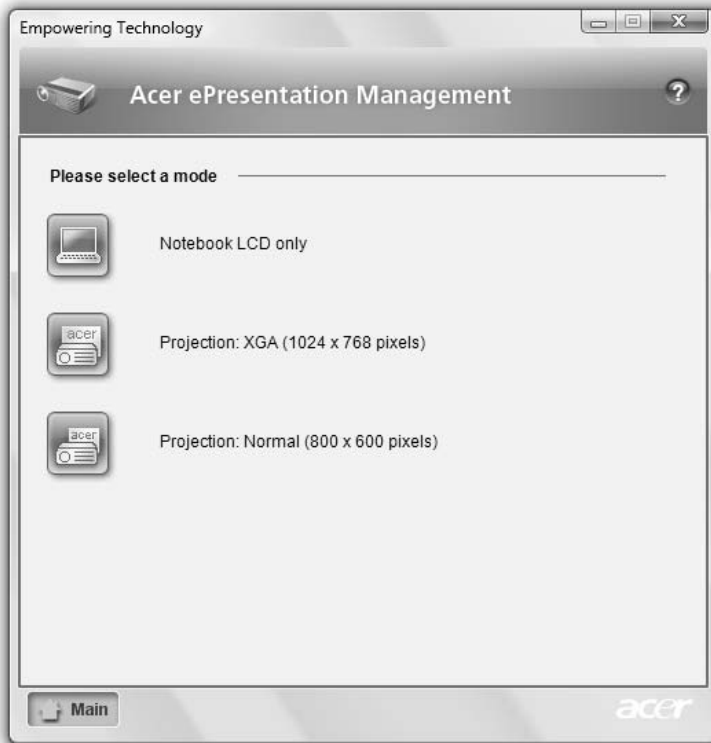

Note: If the restored resolution is not correct after disconnecting a projector, or you need to use an external resolution that is not supported by Acer ePresentation Management, adjust your display settings using Display Properties or the utility provided by the graphics vendor.

Acer eDataSecurity Management (for selected models)

Acer eDataSecurity Management is an encryption utility that protects your files from being accessed by unauthorized persons. It is conveniently integrated with Windows Explorer as a shell extension for quick data encryption/decryption and also supports on-the-fly file encryption for Lotus Notes and Microsoft Outlook.

The Acer eDataSecurity Management setup wizard will prompt you for a supervisor password and default encryption password. This password will be used to encrypt files by default, or you can choose to enter your own password when encrypting a file.



Note: The password used to encrypt a file is the unique key that the system needs to decrypt it. If you lose the password, the supervisor password is the only other key capable of decrypting the file. If you lose both passwords, there will be no way to decrypt your encrypted file! **Be sure to safeguard all related passwords!**



Acer eLock Management

Acer eLock Management is simple yet effective utility that allows you to lock removable storage, optical and floppy drive devices to ensure that data can't be stolen while your system is unattended.

- Removable Storage Devices — includes USB disk drives, USB pen drives, USB flash drives, USB MP3 drives, USB memory card readers, IEEE 1394 disk drives, and any other removable storage devices that can be mounted as a file system when plugged into the system.
- Optical Drive Devices — includes any kind of CD-ROM, DVD-ROM, HD-DVD or Blu-ray drive devices.
- Floppy Drive Devices — 3.5-inch floppy drives only.

To use Acer eLock Management, the Empowering Technology password must be set first. Once set, you can apply locks to any of the devices types. Lock(s) will immediately be set without any reboot necessary, and will remain after rebooting, until removed.



Note: If you lose the Empowering Technology password, there is no method to reset it except by reformatting your system. Make sure to remember or write down your password.



Acer eRecovery Management

Acer eRecovery Management is a versatile backup utility. It allows you to create full or incremental backups, burn the factory default image to optical disc, and restore from previously created backups or reinstall applications and drivers. By default, user-created backups are stored to the D:\ drive.

Acer eRecovery Management provides you with:

- Password protection (Empowering Technology password)
- Full and incremental backups to hard disk or optical disc
- Creation of backups:
 - Factory default image
 - User backup image
 - Current system configuration
 - Application backup
- Restore and recovery:
 - Factory default image
 - User backup image
 - From previously-created CD/DVD
 - Reinstall applications/drivers

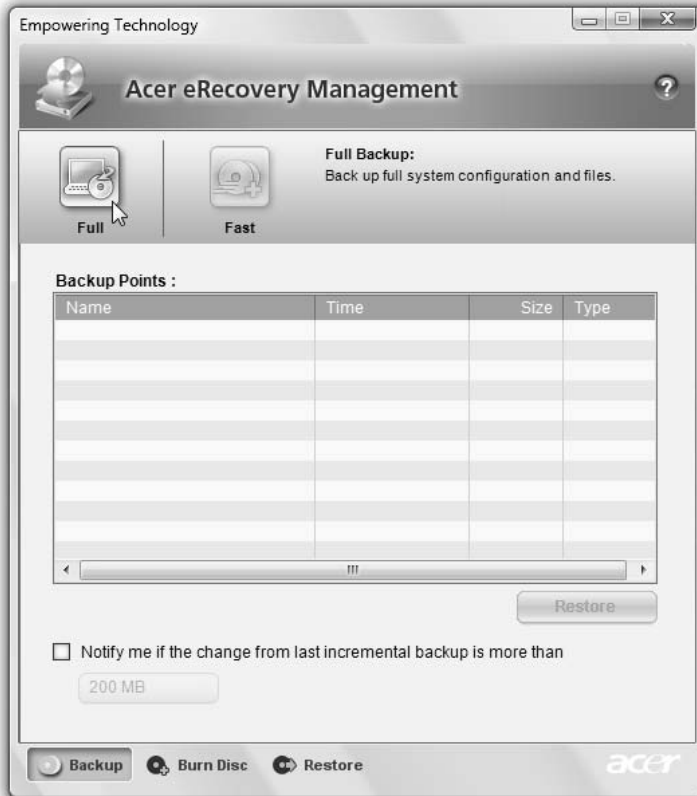

For more information, please refer to **"Acer eRecovery Management"** on page 82 in the **AcerSystem User's Guide**.



.....

Note: If your computer did not come with a Recovery CD or System CD, please use Acer eRecovery Management's "System backup to optical disc" feature to burn a backup image to CD or DVD. To ensure the best results when recovering your system using a CD or Acer eRecovery Management, detach all peripherals (except the external Acer ODD, if your computer has one), including your Acer ezDock.

Acer eSettings Management

Acer eSettings Management allows you to inspect hardware specifications, set BIOS passwords and modify boot options.

Acer eSettings Management also:

- Provides a simple graphical user interface for navigation.
- Prints and saves hardware specifications.
- Lets you set an asset tag for your system.



Windows Mobility Center

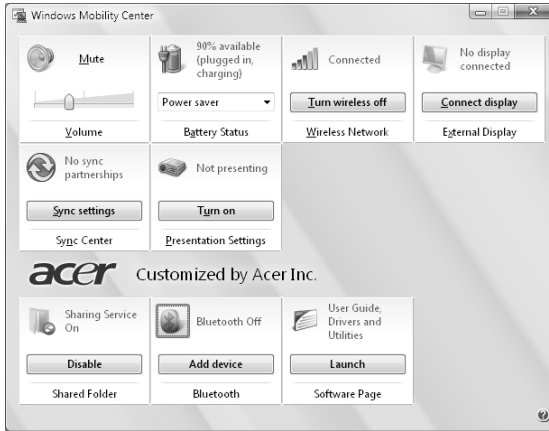

The Windows Mobility Center collects key mobile-related system settings in one easy-to-find place, so you can quickly configure your Acer system to fit the situation as you change locations, networks or activities. Settings include display brightness, power plan, volume, wireless networking on/off, external display settings, display orientation and synchronization status.

Windows Mobility Center also includes Acer-specific settings like Bluetooth Add Device (if applicable), sharing folders overview/sharing service on or off, and a shortcut to the Acer user guide, drivers and utilities.

To launch Windows Mobility Center:

- Use the shortcut key +
- Start Windows Mobility Center from the Control panel
- Start Windows Mobility Center from the Accessories program group in the Start menu

Your Acer notebook tour

After setting up your computer as illustrated in the **Just for Starters...** poster, let us show you around your new Acer notebook.

Top view

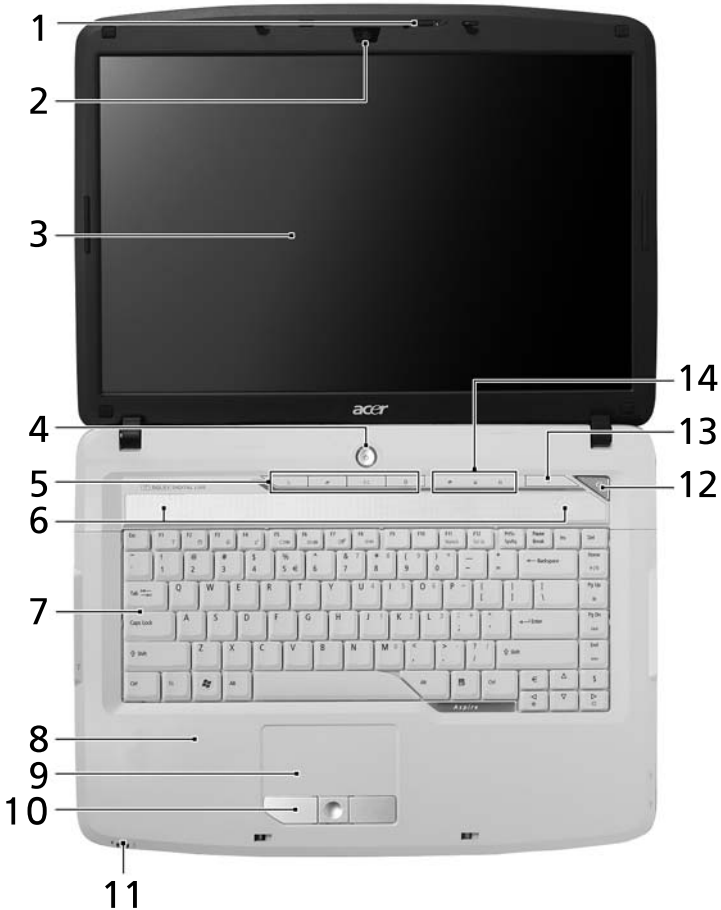

#	ICON	Item	Description
1		Microphone	Internal microphone for sound recording.
2		Acer Crystal Eye	Web camera for video communication. (for selected models)

#	ICON	Item	Description
3		Display screen	Also called Liquid-Crystal Display (LCD), displays computer output.
4		Power button	Turns the computer on and off.
5		Easy-launch buttons	Buttons for launching frequently used programs. See "Easy-launch buttons" on page 26 for more details.
6		Speakers	Left and right speakers deliver stereo audio output.
7		Keyboard	For entering data into your computer.
8		Palmrest	Comfortable support area for your hands when you use the computer.
9		Touchpad	Touch-sensitive pointing device which functions like a computer mouse.
10		Click buttons (left, center and right)	The left and right buttons function like the left and right mouse buttons; the center button serves as a 4-way scroll button.
11		Status indicators	Light-Emitting Diodes (LEDs) that light up to show the status of the computer's functions and components. See "Indicators" on page 25 for more details.
12		Empowering key	Launch Acer Empowering Technology
13		Acer Arcade	For use with Acer Arcade media playing program.
14		Status indicators	Light-Emitting Diodes (LEDs) that light up to show the status of the computer's functions and components. See "Indicators" on page 25 for more details.









Closed front view



#	Icon	Item	Description
1		Line-in jack	Accepts audio line-in devices (e.g., audio CD player, stereo walkman).
2		Microphone-in jack	Accepts input from external microphones.
3		Headphones/speaker/ line-out jack with S/PDIF support	Connects to audio line-out devices (e.g., speakers, headphones).
4		Latch	Locks and releases the lid.
5		CIR receiver	Receives signals from a remote control.





Left view



#	Icon	Item	Description
1		Kensington lock slot	Connects to a Kensington-compatible computer security lock.
2		External display (VGA) port	Connects to a display device (e.g., external monitor, LCD projector).
3	DVI-D	DVI-D port	Connects to a display device with DVI-D input. (for selected models)
4		Ethernet (RJ-45) port	Connects to an Ethernet 10/100/1000-based network.
5		2 USB 2.0 ports	Connect to USB 2.0 devices (e.g., USB mouse, USB camera).
6		S-video/TV-out (NTSC/PAL) port	Connects to a television or display device with S-video input.
7		4-pin IEEE 1394 port	Connects to IEEE 1394 devices.
8		Unlimited volume control wheel	Adjust the volume of the audio-out.
9		5-in-1 card reader	Accepts Secure Digital (SD), MultiMediaCard (MMC), Memory Stick (MS), Memory Stick PRO (MS PRO), xD-Picture Card (xD).
10		ExpressCard/54 slot	Accepts one ExpressCard/54 module.

Right view



#	Icon	Item	Description
1		2 USB 2.0 ports	Connect to USB 2.0 devices (e.g., USB mouse, USB camera).
2		AV-in port	Accepts input signals from audio/video (AV) devices (for selected models).
3		Optical drive	Internal optical drive; accepts CDs or DVDs (slot-load or tray-load depending on model).
4		Optical disk access indicator	Lights up when the optical drive is active.
5		Optical drive eject button	Ejects the optical disk from the drive.
6		Emergency eject hole	Ejects the optical drive tray when the computer is turned off.
7		Modem (RJ-11) port	Connects to a phone line.
8		RF-in jack	Accepts input signals from digital TV-tuner devices (for selected models).





Rear view



#	Icon	Item	Description
1		DC-in jack	Connects to an AC adapter.
2		Ventilation slots	Enable the computer to stay cool, even after prolonged use.

Base view



#	Icon	Item	Description
1		Battery bay	Houses the computer's battery pack.
2		Battery release latch	Releases the battery for removal.
3		Battery lock	Locks the battery in position.
4		Memory compartment	Houses the computer's main memory.
5		Hard disk bay	Houses the computer's hard disk (secured with screws).
6		Ventilation slots and cooling fan	Enable the computer to stay cool, even after prolonged use. Note: Do not cover or obstruct the opening of the fan.

Specifications

Operating system	<ul style="list-style-type: none"> Windows Vista™ Ultimate Windows Vista™ Home Premium Windows Vista™ Home Basic Windows Vista™ Starter
Platform	<p>AMD Better By Design program, featuring:</p> <ul style="list-style-type: none"> AMD Turion™ 64 X2 dual-core mobile technology TL-68/TL-66 / TL-64 / TL-60 / TL-58 / TL-56 / TL-52 (2x512 KB L2 cache, 2.4/2.3/ 2.2/ 2.0/1.9/1.8/1.6 GHz, supporting AMD HyperTransport® technology (for selected models) AMD Athlon™ 64 X2 Mobile Technology TK-53/TK-55/TK-57 (1.70/ 1.80/1.90 GHz, 2x 256 KB L2 cache), supporting AMD PowerNow!™ technology and AMD HyperTransport™ technology (for selected models) AMD Turion™ 64 Mobile Technology MK-36/MK-38 (2/2.20 GHz, 512 KB L2 cache), supporting AMD PowerNow!™ technology and AMD HyperTransport™ technology (for selected models) Mobile AMD Sempron™ 3500+ (1.80 GHz, 512 KB L2 cache), 3600+/3800+ (2/2.20 GHz, 256 KB L2 cache) (for selected models) NVIDIA nForce® 610M (MCP67-MV) Acer InViLink™ 802.11b/g Wi-Fi CERTIFIED® solution, supporting Acer SignalUp™ wireless technology
System memory	Up to 2 GB of DDR2 667 MHz memory, upgradeable to 4 GB using two soDIMM modules (dual-channel support)
TV-tuner	<p>Acer TV-tuner options: (for selected models) Digital TV-tuner supporting DVB-T (Digital Video Broadcasting Terrestrial) standard (6 MHz to 8 MHz) TV-tuner I/O:</p> <ul style="list-style-type: none"> RF jack for digital/analog TV antenna cable input <p>TV-tuner cables:</p> <ul style="list-style-type: none"> PAL cable for digital TV input, PAL/SECAM to NTSC port converter <p>Acer DVB-T antenna (UHF/VHF reception) supporting Acer SignalUp™ wireless technology</p>
Display	15.4" WXGA high-brightness (220-nits) Acer CrystalBrite™ TFT LCD, 1280 x 800 pixel resolution, supporting simultaneous multi-window viewing via Acer GridVista™ 8 ms response time

Graphics	<ul style="list-style-type: none"> • NVIDIA® GeForce® 9300M GS with up to 2047 MB of TurboCache™ (256 MB of dedicated GDDR2 VRAM, up to 1791 MB of shared system memory), supporting NVIDIA® PureVideo™ HD technology, OpenEXR High Dynamic-Range (HDR) technology, Shader Model 4.0, Microsoft® DirectX® 10 (for selected models) • NVIDIA GeForce® 8400M G with up to 1024MB of Turbocache™ (256MB of dedicated GDDR2 VRAM, up to 768MB of share system memory), supporting Microsoft DirectX 9 and DirectX 10, and PCI Express® (for selected models) • NVIDIA GeForce® 8600M GS with up to 1280MB of TurboCache™ technology (512MB of dedicated GDDR2 VRAM, 768MB of share system memory), Microsoft DirectX 9 and DirectX 10 support, PCI Express® • NVIDIA GeForce® 7000M with up to 896MB of Turbocache™ (256MB of dedicated system memory, up to 640MB of share system memory), Microsoft DirectX 9 and PCI Express (for selected models) • Dual independent display support • 16.7 million colors (for selected models) • MPEG-2/DVD hardware-assisted capability (full decode) (for selected models) • WMV9 (VC-1) and H.264 (AVC) support (full decode) (for selected models) • S-video/TV-out (NTSC/PAL) support • DVI-D (true digital video interface) with High-bandwidth Digital Content Protection (HDCP) support (for selected models) • Acer Arcade™ featuring Acer CinemaVision™ and Acer ClearVision™ technologies
Storage subsystem	<ul style="list-style-type: none"> • 80/120/160/200/250 GB or larger hard disk drive • Optical drive options: <ul style="list-style-type: none"> • Blu-ray Disc™ drive (for selected models) • HD-DVD drive (for selected models) • DVD-Super Multi double-layer drive (for selected models) • DVD/CD-RW combo drive (for selected models) • 5-in-1 card reader, supporting Secure Digital (SD), MultiMediaCard (MMC), Memory Stick® (MS), Memory Stick PRO™ (MS PRO), xD-Picture Card™ (xD)
Audio	<ul style="list-style-type: none"> • Dolby®-certified surround sound system with two built-in stereo speakers • Dolby® Home Theater audio enhancement featuring Dolby® Digital, Dolby® Digital Live, Dolby® PRO LOGIC® II, Dolby® Digital Stereo Creator, Dolby® Headphone and Dolby® Virtual Speaker technologies • High Definition Audio support • S/PDIF (Sony/Philips Digital Interface) support for digital speakers • MS-Sound compatible • Built-in microphone

Communication	<p>Acer Video Conference, featuring:</p> <ul style="list-style-type: none"> • Integrated Acer Crystal Eye webcam, supporting Acer PrismaLite™ technology (for selected models) • Acer Xpress VoIP phone (for selected models) • WLAN: Acer InviLink™ 802.11b/g Wi-Fi CERTIFIED® network connection, supporting Acer SignalUp™ wireless technology • WPAN: Bluetooth® 2.0+EDR (Enhanced Data Rate) (for selected models) • LAN: Gigabit Ethernet; Wake-on-LAN ready • Modem: 56K ITU V.92 with PTT approval; Wake-on-Ring ready
Dimensions and weight	<ul style="list-style-type: none"> • 366 (W) x 274 (D) x 33.6/42.6 (H) mm (14.4 x 10.8 x 1.3/1.7 inches) • 2.75 kg (6.06 lbs.) with 6-cell battery
Power subsystem	<ul style="list-style-type: none"> • ACPI 3.0 CPU power management standard: supports Standby and Hibernation power-saving modes • 71 W 4800 mAh Li-ion battery pack (8-cell) • 44.4 W 4000 mAh Li-ion battery pack (6-cell) • 3-pin 65 W AC adaptor (for selected models) <ul style="list-style-type: none"> • 2.5-hour rapid charge system-off • 3.5-hour charge-in-use • 3-pin 90 W AC adapter supporting Acer QuicCharge™ technology: (for selected models) <ul style="list-style-type: none"> • 80% charge in 1 hour • 2-hour rapid charge system-off • 3-hour charge-in-use
Special keys and controls	<ul style="list-style-type: none"> • 88-/89-/93-key keyboard, with inverted "T" cursor layout; 2.5 mm (minimum) key travel • Seamless touchpad with 4-way scroll button • 12 function keys, four cursor keys, two Windows® keys, hotkey controls, embedded numeric keypad, international language support, independent US and Euro dollar sign keys, media control keys • Four media control keys: play/pause, stop, next, previous • Empowering Key • Easy-launch buttons: WLAN, Internet, email, Bluetooth, Acer Arcade™ • Volume wheel
I/O interface	<ul style="list-style-type: none"> • ExpressCard™/54 slot • 5-in-1 card reader (SD™/MMC/MS/MS PRO/xD) • Four USB 2.0 ports • DVI-D port with HDCP support (for selected models) • IEEE 1394 port • Consumer infrared (CIR) port • External display (VGA) port • S-video/TV-out (NTSC/PAL) port • RF-in jack (for selected models) • AV-in port (for selected models) • Headphones/speaker/line-out port with S/PDIF support • Microphone-in jack • Line-in jack • Ethernet (RJ-45) port • Modem (RJ-11) port • DC-in jack for AC adapter

Options and accessories	<ul style="list-style-type: none"> • Acer Xpress VoIP phone featuring Acer Video Conference Manager • Acer Media Center remote control • 512 MB, 1 or 2GB DDR2 667 MHz soDIMM modules • 8-cell Li-ion battery pack • 3-pin 90 W AC adapter • External USB floppy disk drive
Software	<ul style="list-style-type: none"> • Acer Empowering Technology (Acer eNet, ePower, eAudio, ePresentation, eDataSecurity (for selected models), eLock, eRecovery, eSettings Management) • Acer Arcade™ featuring Cinema, Video, Album, Music, Acer HomeMedia • Acer Arcade Deluxe™ featuring DV Wizard, SportsCap, VideoMagician, DVDivine and Acer HomeMedia • Acer Crystal Eye • Acer GridVista™ • Acer GameZone™ • Acer Launch Manager • Acer Video Conference Manager • Adobe® Reader® • CyberLink® PowerProducer® • • NTI CD-Maker™ • Microsoft Works 8.5 with Office Home and Student 2007 Trial
<div style="display: flex; align-items: center;">  <p style="border-top: 1px dashed black; padding-top: 5px;">Note: Software listed above is for reference only. The exact configuration of your PC depends on the model purchased.</p> </div>	
Environment	<ul style="list-style-type: none"> • Temperature: <ul style="list-style-type: none"> • Operating: 5 °C to 35 °C • Non-operating: -20 °C to 65 °C • Humidity (non-condensing): <ul style="list-style-type: none"> • Operating: 20% to 80% • Non-operating: 20% to 80%
System compliance	<ul style="list-style-type: none"> • Wi-Fi® • ACPI • Mobile PC 2002 • DMI 2.0
Warranty	One-year International Travelers Warranty (ITW)







Note: The specifications listed above are for reference only. The exact configuration of your PC depends on the model purchased.

Indicators

The computer has several easy-to-read status indicators.



The front panel indicators are visible even when the computer cover is closed up.

Icon	Function	Description
	Power	Indicates the computer's power status.
	Battery	Indicates the computer's battery status.
	HDD	Indicates when the hard disk drive is active.
	Num Lock	Lights up when Num Lock is activated.
	Caps Lock	Lights up when Caps Lock is activated.



-
- 1. Charging:** The light shows amber when the battery is charging.
 - 2. Fully charged:** The light shows green when in AC mode.

Easy-launch buttons

Located beside the keyboard are application buttons. These buttons are called easy-launch buttons. They are: Empowering Key, WLAN, Internet, email, Bluetooth, TV (optional) and Acer Arcade.

Press **e** to run the Acer Empowering Technology. Please see "**Acer Empowering Technology**" on page 1. The mail and Web browser buttons are pre-set to email and Internet programs, but can be reset by users. To set the Web browser, mail and programmable buttons, run the Acer Launch Manager. See "**Launch Manager**" on page 38.



Icon	Function	Description
	Empowering Technology	Launch Acer Empowering Technology. (user-programmable)
	Wireless communication button/indicator	Enables/disables the wireless function. Indicates the status of wireless LAN communication.
	Web browser	Internet browser (user-Programmable)
	Mail	Email application (user-Programmable)
	Bluetooth communication button/indicator	Enables/disables the Bluetooth function. Indicates the status of Bluetooth communication.
	Acer Arcade	Launch Acer Arcade utility

Touchpad

The built-in seamless touchpad is a pointing device that senses movement on its surface. This means the cursor responds as you move your finger across the surface of the touchpad. The central location on the palmrest provides optimum comfort and support.



Touchpad basics

The following items show you how to use the touchpad:

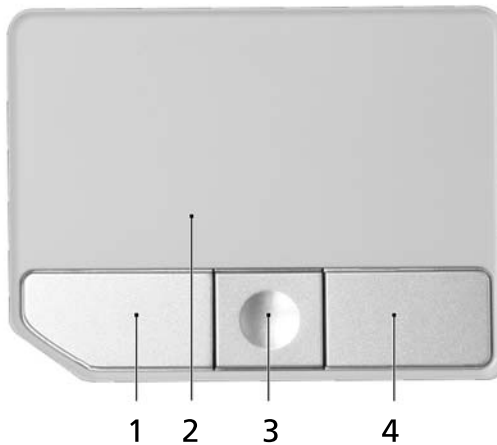

- Move your finger across the touchpad **(2)** to move the cursor.

- Press the left **(1)** and right **(4)** buttons located beneath the touchpad to perform selection and execution functions. These two buttons are similar to the left and right buttons on a mouse. Tapping on the touchpad is the same as clicking the left button.
- Use the 4-way scroll **(3)** button to scroll up or down and move left or right a page. This button mimics your cursor pressing on the right scroll bar of Windows applications.

Function	Left button (1)	Right button (4)	Main touchpad (2)	Center button (3)
Execute	Quickly click twice.		Tap twice (at the same speed as double-clicking a mouse button).	
Select	Click once.		Tap once.	
Drag	Click and hold, then use finger on the touchpad to drag the cursor.		Tap twice (at the same speed as double-clicking a mouse button); rest your finger on the touchpad on the second tap and drag the cursor.	
Access context menu		Click once.		
Scroll				Click and hold to move up/down/left/right.



.....

Note: When using the touchpad, keep it — and your fingers — dry and clean. The touchpad is sensitive to finger movement; hence, the lighter the touch, the better the response. Tapping harder will not increase the touchpad's responsiveness.



.....

Note: By default, vertical and horizontal scrolling is enabled on your touchpad. It can be disabled under Mouse settings in Windows Control Panel.

Using the keyboard

The keyboard has full-sized keys and an embedded numeric keypad, separate cursor, lock, Windows, function and special keys.

Lock keys and embedded numeric keypad

The keyboard has three lock keys which you can toggle on and off.

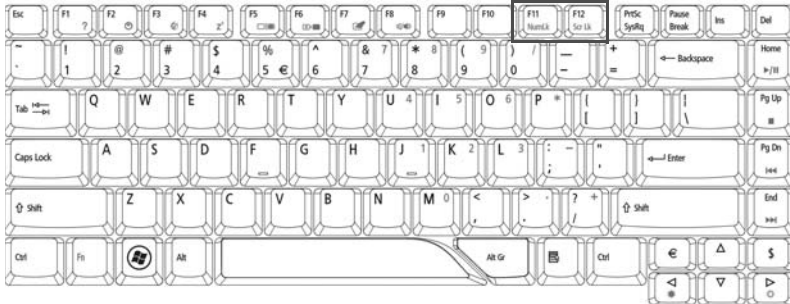





















Lock key	Description
Caps Lock	When Caps Lock is on, all alphabetic characters typed are in uppercase.
Num Lock <Fn> + <F11>	When Num Lock is on, the embedded keypad is in numeric mode. The keys function as a calculator (complete with the arithmetic operators +, -, *, and /). Use this mode when you need to do a lot of numeric data entry. A better solution would be to connect an external keypad.
Scroll Lock <Fn> + <F12>	When Scroll Lock is on, the screen moves one line up or down when you press the up or down arrow keys respectively. Scroll Lock does not work with some applications.

The embedded numeric keypad functions like a desktop numeric keypad. It is indicated by small characters located on the upper right corner of the keycaps. To simplify the keyboard legend, cursor-control key symbols are not printed on the keys.

Desired access	Num Lock on	Num Lock off
Number keys on embedded keypad	Type numbers in a normal manner.	
Cursor-control keys on embedded keypad	Hold <Shift> while using cursor-control keys.	Hold <Fn> while using cursor-control keys.
Main keyboard keys	Hold <Fn> while typing letters on embedded keypad.	Type the letters in a normal manner.

Windows keys

The keyboard has two keys that perform Windows-specific functions.

Key	Description
 Windows key	<p>Pressed alone, this key has the same effect as clicking on the Windows Start button; it launches the Start menu. It can also be used with other keys to provide a variety of functions:</p> <ul style="list-style-type: none"> < > : Open or close the Start menu < > + <D>: Display the desktop < > + <E>: Open Windows Explore < > + <F>: Search for a file or folder < > + <G>: Cycle through Sidebar gadgets < > + <L>: Lock your computer (if you are connected to a network domain), or switch users (if you're not connected to a network domain) < > + <M>: Minimizes all windows < > + <R>: Open the Run dialog box < > + <T>: Cycle through programs on the taskbar < > + <U>: Open Ease of Access Center < > + <X>: Open Windows Mobility Center < > + <BREAK>: Display the System Properties dialog box < > + <SHIFT+M>: Restore minimized windows to the desktop < > + <TAB>: Cycle through programs on the taskbar by using Windows Flip 3-D < > + <SPACEBAR>: Bring all gadgets to the front and select Windows Sidebar <CTRL> + < > + <F>: Search for computers (if you are on a network) <CTRL> + < > + <TAB>: Use the arrow keys to cycle through programs on the taskbar by using Windows Flip 3-D
	<p>.....</p> <p>Note: Depending on your edition of Windows Vista, some shortcuts may not function as described.</p>
 Application key	<p>This key has the same effect as clicking the right mouse button; it opens the application's context menu.</p>

Hotkeys

The computer employs hotkeys or key combinations to access most of the computer's controls like screen brightness, volume output and the BIOS utility.

To activate hotkeys, press and hold the **<Fn>** key before pressing the other key in the hotkey combination.

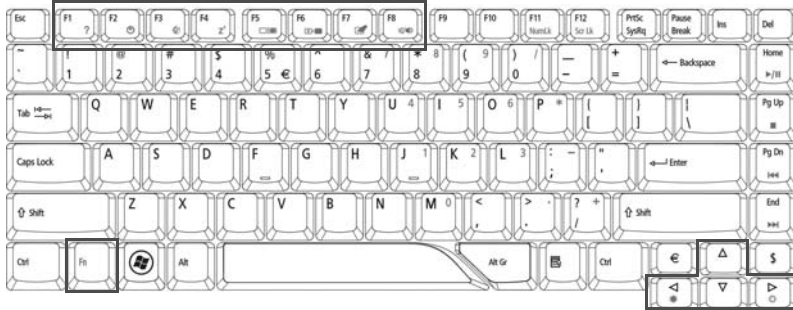

Hotkey	Icon	Function	Description
<Fn> + <F1>	?	Hotkey help	Displays help on hotkeys.
<Fn> + <F2>		Acer eSettings	Launches Acer eSettings in Acer Empowering Technology. See " Acer Empowering Technology " on page 1.
<Fn> + <F3>		Acer ePower Management	Launches Acer ePower Management in Acer Empowering Technology. See " Acer Empowering Technology " on page 1.
<Fn> + <F4>	Z ^z	Sleep	Puts the computer in Sleep mode.
<Fn> + <F5>		Display toggle	Switches display output between the display screen, external monitor (if connected) and both.
<Fn> + <F6>		Screen blank	Turns the display screen backlight off to save power. Press any key to return.
<Fn> + <F7>		Touchpad toggle	Turns the internal touchpad on and off.
<Fn> + <F8>		Speaker toggle	Turns the speakers on and off.
<Fn> + <+>		Brightness up	Increases the screen brightness.
<Fn> + <->		Brightness down	Decreases the screen brightness.

Special keys

You can locate the Euro symbol and the US dollar sign at the upper-center and/or bottom-right of your keyboard.

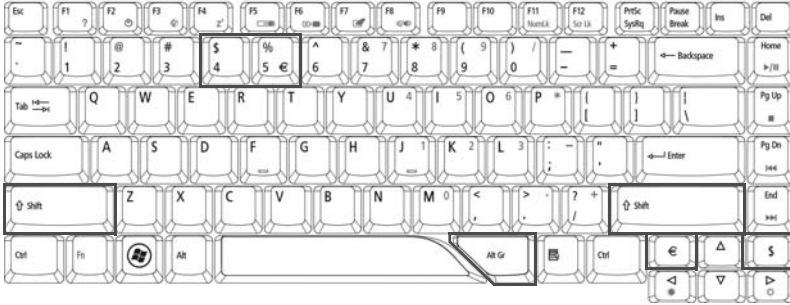

The Euro symbol

- 1 Open a text editor or word processor.
- 2 Either press <€> at the bottom-right of the keyboard, or hold <Alt Gr> and then press the <5> key at the upper-center of the keyboard.



.....
Note: Some fonts and software do not support the Euro symbol. Please refer to www.microsoft.com/typography/faq/faq12.htm for more information.

The US dollar sign

- 1 Open a text editor or word processor.
- 2 Either press <\$> at the bottom-right of the keyboard, or hold <Shift> and then press the <4> key at the upper-center of the keyboard.



.....
Note: This function varies according to the language settings.

Ejecting the optical (CD or DVD) drive tray

Press the drive eject button to eject the optical drive tray when the computer is on.



Insert a paper clip to the emergency eject hole to eject the optical drive tray when the computer is off.

Using a computer security lock

The notebook comes with a Kensington-compatible security slot for a security lock.

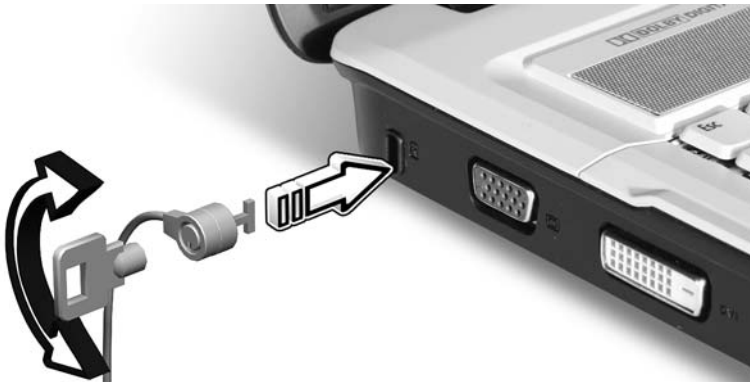

Wrap the computer security lock cable around an immovable object such as a table or handle of a locked drawer. Insert the lock into the notch and turn the key to secure the lock. Some keyless models are also available.

Audio

The computer comes with 32-bit High-Definition audio, and Dolby® certified surround sound system with two built-in stereo speakers.



Adjusting the volume

Adjusting the volume on the computer is as easy as scrolling unlimited volume control wheel on the front panel.

Using Dolby Home Theater for surround/multi-channel sound

Your Acer notebook comes with the Dolby® Home Theater audio enhancement featuring Dolby® PRO LOGIC II, Dolby® Digital Live, Dolby® Headphone, Dolby® Virtual Speaker technologies to give you high-quality digital surround sound for enjoying movies, games and music in a realistic, multi-channel audio environment.

Dolby Pro Logic II

Dolby Pro Logic II transforms any stereo signal into five-channel, full-range surround sound.

Dolby Digital Live

Found in PC and console-based video game applications, Dolby Digital Live converts any stereo or multichannel audio signal to a Dolby Digital format for a dramatic, real-time audio experience and simple (one plug) connection to an A/V receiver for playback.

Dolby Headphone

Dolby Headphone offers realistic surround sound from any pair of headphones. It's perfect for late night listening.

Dolby Virtual Speaker

Surround yourself with sound, not speakers. Dolby Virtual Speaker delivers a 5.1-channel surround sound listening experience from just two speakers.

Set playback as digital output

To set up surround sound, select the **Playback Devices** by right-clicking the **Volume Mixer** icon in the system tray of your Windows system.



The Playback Devices dialog box will pop up. There are three tabs: **Playback**, **Recording** and **Sounds**. Click the **Playback** tab, and then select **Realtek Digital Output** and click **Set Default** to set the digital output.

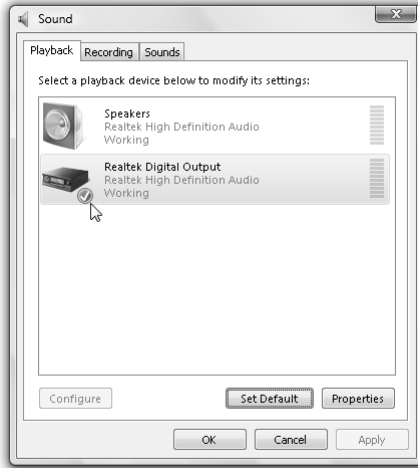

For enjoying movies, games and music in a realistic, multi-channel audio environment, please see Acer eAudio Management.

Using the system utilities

Acer GridVista (dual-display compatible)



Note: This feature is only available on certain models.

To enable the dual display feature of your notebook, first ensure that a second display is connected, then, open the Display Settings properties box using the Control Panel or by right-clicking the Windows desktop and selecting **Personalize**. Select the secondary monitor **(2)** icon in the display box and then click the check box **Extend the desktop onto this monitor**. Finally, click **Apply** to confirm the new settings and click **OK** to complete the process.

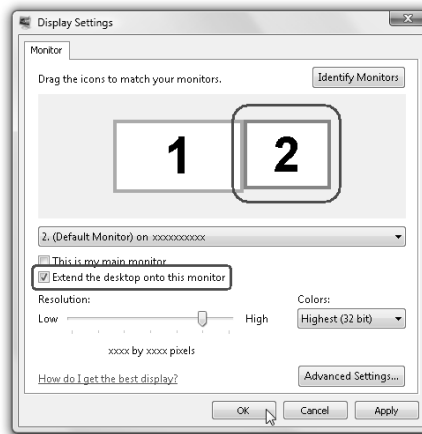

Acer GridVista is a handy utility that offers four pre-defined display settings so you can view multiple windows on the same screen. To access this function, please go to **Start, All Programs** and click on **Acer GridVista**. You may choose any one of the four display settings indicated below:

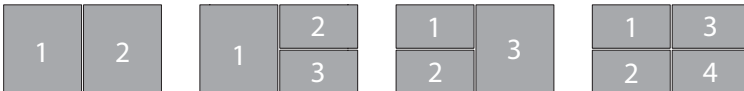

Double (vertical), Triple (primary at left), Triple (primary at right), or Quad

Acer GridVista is dual-display compatible, allowing two displays to be partitioned independently.

Acer GridVista is simple to set up:

- 1 Run Acer GridVista and select your preferred screen configuration for each display from the taskbar.
- 2 Drag and drop each window into the appropriate grid.
- 3 Enjoy the convenience of a well-organized desktop.

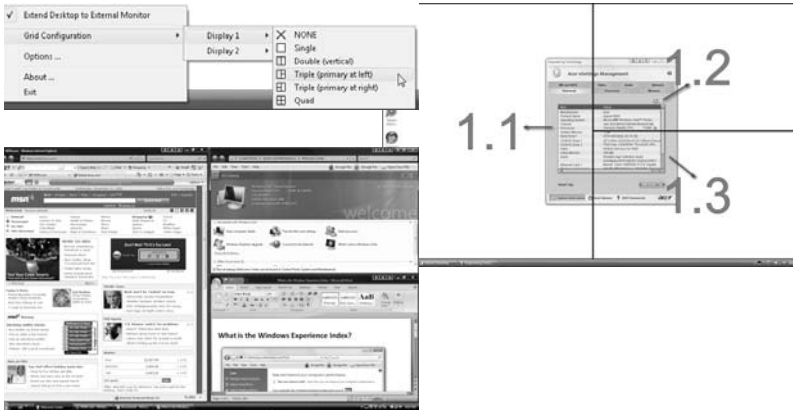

Note: Please ensure that the resolution setting of your second monitor is set to the manufacturer's recommended value.

Launch Manager



Launch Manager allows you to set the four easy-launch buttons located above the keyboard. **"Easy-launch buttons" on page 26** for the location of the easy-launch buttons.

You can access the Launch Manager by clicking on **Start, All Programs**, and then **Launch Manager** to start the application.

Frequently asked questions

The following is a list of possible situations that may arise during the use of your computer. Easy solutions are provided for each one.

I turned on the power, but the computer does not start or boot up.

Look at the power indicator:

- If it is not lit, no power is being supplied to the computer. Check the following:
 - If you are using on the battery, it may be low and unable to power the computer. Connect the AC adapter to recharge the battery pack.
 - Make sure that the AC adapter is properly plugged into the computer and to the power outlet.
- If it is lit, check the following:
 - Is a non-bootable (non-system) disk in the external USB floppy drive? Remove or replace it with a system disk and press **<Ctrl> + <Alt> + ** to restart the system.

Nothing appears on the screen.

The computer's power management system automatically blanks the screen to save power. Press any key to turn the display back on.

If pressing a key does not turn the display back on, three things might be the cause:

- The brightness level might be too low. Press **<Fn> + <→>** (increase) to adjust the brightness level.
- The display device might be set to an external monitor. Press the display toggle hotkey **<Fn> + <F5>** to toggle the display back to the computer.
- If the Sleep indicator is lit, the computer is in Sleep mode. Press and release the power button to resume.

No audio is heard from the computer.

Check the following:

- The volume may be muted. In Windows, look at the volume control (speaker) icon on the taskbar. If it is crossed-out, click on the icon and deselect the **Mute all** option.
- The volume level may be too low. In Windows, look at the volume control icon on the taskbar. You can also use the unlimited volume control wheel to adjust the volume. See "**Left view**" on page 18 for more detail.

- If headphones, earphones or external speakers are connected to the line-out port on the computer, the internal speakers automatically turn off.

I want to eject the optical drive tray without turning on the power.

There is a mechanical eject hole on the optical drive. Simply insert the tip of a pen or paperclip into the hole and push to eject the tray. (If your computer's optical drive is a slot-load model, it will not have an eject hole.)

The keyboard does not respond.

Try attaching an external keyboard to a USB port on the computer. If it works, contact your dealer or an authorized service center as the internal keyboard cable may be loose.

The printer does not work.

Check the following:

- Make sure that the printer is connected to a power outlet and that it is turned on.
- Make sure that the printer cable is connected securely to the computer's parallel port or a USB port and the corresponding port on the printer.

I want to set up my location to use the internal modem.

To properly use your communication software, you need to set up your location:

- 1 Click on **Start, Control Panel**.
- 2 Double-click on **Phone and Modem Options**.
- 3 Begin setting up your location.

Refer to the Windows manual.



.....

Note: Please note, on first booting your notebook, that you can skip the Internet Connection setup, as it is not necessary to complete the installation of your Operating System. After the Operating System is set up, you can proceed with the Internet Connection setup.

I want to restore my computer to its original settings without

recovery CDs.



.....

Note: If your system is the multilingual version, the operating system and language you choose when you first turn on the system will be the only option for future recovery operations.

This recovery process helps you restore the C: drive with the original software content that is installed when you purchase your notebook. Follow the steps below to rebuild your C: drive. (Your C: drive will be reformatted and all data will be erased.) It is important to back up all data files before using this option.

Before performing a restore operation, please check the BIOS settings.

- 1 Check to see if **Acer disk-to-disk recovery** is enabled or not.
- 2 Make sure the **D2D Recovery** setting in **Main** is **Enabled**.
- 3 Exit the BIOS utility and save changes. The system will reboot.



.....

Note: To activate the BIOS utility, press **<F2>** during POST.

To start the recovery process:

- 1 Restart the system.
- 2 While the Acer logo is showing, press **<Alt> + <F10>** at the same time to enter the recovery process.
- 3 Refer to the onscreen instructions to perform system recovery.



.....

Important! This feature occupies 10 GB in a hidden partition on your hard disk.

Requesting service

International Travelers Warranty (ITW)

Your computer is backed by an International Travelers Warranty (ITW) that gives you security and peace of mind when traveling. Our worldwide network of service centers are there to give you a helping hand.

An ITW passport comes with your computer. This passport contains all you need to know about the ITW program. A list of available, authorized service centers is in this handy booklet. Read this passport thoroughly.

Always have your ITW passport on hand, especially when you travel, to receive the benefits from our support centers. Place your proof-of-purchase in the flap located inside the front cover of the ITW passport.

If the country you are traveling in does not have an Acer-authorized ITW service site, you can still get in contact with our offices worldwide. Please consult <http://global.acer.com>.

Before you call

Please have the following information available when you call Acer for online service, and please be at your computer when you call. With your support, we can reduce the amount of time a call takes and help solve your problems efficiently. If there are error messages or beeps reported by your computer, write them down as they appear on the screen (or the number and sequence in the case of beeps).

You are required to provide the following information:

Name: _____

Address: _____

Telephone number: _____

Machine and model type: _____

Serial number: _____

Date of purchase: _____

Battery pack

The computer uses a battery pack that gives you long use between charges.

Battery pack characteristics

The battery pack has the following characteristics:

- Employs current battery technology standards.
- Delivers a battery-low warning.

The battery is recharged whenever you connect the computer to the AC adapter. Your computer supports charge-in-use, enabling you to recharge the battery while you continue to operate the computer. However, recharging with the computer turned off results in a significantly faster charge time.

The battery will come in handy when you travel or during a power failure. It is advisable to have an extra fully charged battery pack available as backup. Contact your dealer for details on ordering a spare battery pack.

Maximizing the battery's life

Like all other batteries, your computer's battery will degrade over time. This means that the battery's performance will diminish with time and use. To maximize your battery's life, you are advised to adhere to the recommendations set out below.

Conditioning a new battery pack

Before you use a battery pack for the first time, there is a "conditioning" process that you should follow:

- 1 Insert the new battery without turning the computer on.
- 2 Connect the AC adapter and fully charge the battery.
- 3 Disconnect the AC adapter.
- 4 Turn on the computer and operate using battery power.
- 5 Fully deplete the battery until the battery-low warning appears.
- 6 Reconnect the AC adapter and fully charge the battery again.

Follow these steps again until the battery has been charged and discharged three times.

Use this conditioning process for all new batteries, or if a battery hasn't been used for a long time. If the computer is to be stored for more than two weeks, you are advised to remove the battery pack from the unit.



.....
Warning: Do not expose battery packs to temperatures below 0°C (32°F) or above 45°C (113°F). Extreme temperatures may adversely affect the battery pack.

By following the battery conditioning process you condition your battery to accept the maximum possible charge. Failure to follow this procedure will prevent you from obtaining the maximum battery charge, and will also shorten the effective lifespan of the battery.

In addition, the useful lifespan of the battery is adversely affected by the following usage patterns:

- Using the computer on constant AC power with the battery inserted. If you want to use constant AC power, you are advised to remove the battery pack after it is fully charged.
- Not discharging and recharging the battery to its extremes, as described above.
- Frequent use; the more you use the battery, the faster it will reach the end of its effective life. A standard computer battery has a life span of about 300 charges.

Installing and removing the battery pack



.....
Important! Before removing the battery from the unit, connect the AC adapter if you want to continue using your computer. Otherwise, turn off the computer first.

To install a battery pack:

- 1 Align the battery with the open battery bay; make sure that the end with the contacts will enter first, and that the top surface of the battery is facing up.
- 2 Slide the battery into the battery bay and gently push until the battery locks in place.

To remove a battery pack:

- 1 Slide the battery release latch to release the battery.
- 2 Pull the battery from the battery bay.

Charging the battery

To charge the battery, first make sure that it is correctly installed in the battery bay. Plug the AC adapter into the computer, and connect to a mains power outlet. You can continue to operate your computer on AC power while your battery is charging. However, charging the battery with the computer turned off results in a significantly faster charge time.



.....
Note: You are advised to charge the battery before retiring for the day. Charging the battery overnight before traveling enables you to start the next day with a fully charged battery.

Checking the battery level

The Windows power meter indicates the current battery level. Rest the cursor over the battery/power icon on the taskbar to see the battery's present charge level.

Optimising battery life

Optimizing battery life helps you get the most out of battery operation, prolonging the charge/recharge cycle and improving recharging efficiency. You are advised to follow the suggestions set out below:

- Purchase an extra battery pack.
- Use AC power whenever possible, reserving battery for on-the-go use.
- Eject a PC Card if it is not being used, as it will continue to draw power (for selected model).
- Store the battery pack in a cool, dry place. The recommended temperature is 10°C (50°F) to 30°C (86°F). Higher temperatures cause the battery to self-discharge faster.
- Excessive recharging decreases the battery life.
- Look after your AC adapter and battery.

Battery-low warning

When using battery power pay attention to the Windows power meter.



Warning: Connect the AC adapter as soon as possible after the battery-low warning appears. Data will be lost if the battery to become fully depleted and the computer shuts down.

When the battery-low warning appears, the recommended course of action depends on your situation:

Situation	Recommended Action
The AC adapter and a power outlet are available.	<ol style="list-style-type: none"> 1. Plug the AC adapter into the computer, and then connect to the mains power supply. 2. Save all necessary files. 3. Resume work. <p>Turn off the computer if you want to recharge the battery rapidly.</p>
An extra fully charged battery pack is available.	<ol style="list-style-type: none"> 1. Save all necessary files. 2. Close all applications. 3. Shut down the operating system to turn off the computer. 4. Replace the battery pack. 5. Turn on the computer and resume work.
The AC adapter or a power outlet is unavailable. You have no spare battery pack.	<ol style="list-style-type: none"> 1. Save all necessary files. 2. Close all applications. 3. Shut down the operating system to turn off the computer.

Acer Arcade (for selected models)

Acer Arcade is an integrated player for music, photos, TV, DVD movies and videos. It can be operated using your pointing device or remote control.

To watch or listen, click or select a content button (e.g., Music, Video, etc.) on the Arcade home page.



- **Music** — listen to music files in a variety of formats
- **TV** — watch and record digital or analog TV programs (for selected models)
- **Cinema** — watch DVDs or VCDs
- **Video** — watch video clips
- **Album** — view photos stored on your hard disk or removable media



.....

Note: While watching videos, DVDs or slide shows, your screensaver and power-saving features are unavailable.

Finding and playing content

Clicking a button on the Arcade home page opens the corresponding feature's home page. The content pages have buttons on the left and a content browsing area on the right. If a button shows one of several choices, such as sort order, the current setting is shown by a brightly colored ball on the button.

To pick content, click an item in the content area. When there is more than one CD or DVD drive, all drives will be shown. Pictures and videos are shown as files (with thumbnails) and organized into folders.

To browse a folder, click to open it. To go back up to the folder above it, click the **Up one level** button. If there is more content than will fit on a page, use the buttons at the lower right to scroll through the pages.



Note: For more detailed information on the features of Acer Arcade, please refer to the Arcade Help menu. This can be accessed from the Arcade home page by selecting **Help** .

Settings

There are settings in Acer Arcade that allow you to fine-tune its performance to suit your machine and your personal preferences. To access Settings, click on this icon  located on the upper-right hand corner of the main page.

Click **Acer Arcade Help** for comprehensive help on each Arcade mode.

In Display Settings:

Use the "Screen Ratio" option to choose between standard (4:3) or widescreen (16:9) display when watching movies.

The "4:3 Movie Display Type" option allows you to select between "CinemaVision™" or "Letterbox" mode.

- Acer CinemaVision™ is a nonlinear video stretching technology that produces minimal distortion in the center of the picture.
- The **Letterbox** option displays widescreen movie content in its original aspect ratio and adds black bars at the top and bottom of the screen.

"Color profile" allows you to choose between "Original" or "ClearVision™."

- Acer ClearVision™ is a video enhancement technology that detects video content and dynamically adjusts the brightness/contrast/saturation levels so that you do not need to change the color settings if the movie you are watching contains scenes that are overly dark or too bright.

In **Audio Settings**:

Use "Speaker Environment" to choose between "Headphones," "SPDIF," "2" or more speakers depending on your audio equipment.

"Output Mode" should be set to "Stereo" if you are listening to speakers, "Dolby Surround," or "Virtual Surround Sound" if you are using headphones.



.....

Note: If your speakers are not capable of outputting low-frequency signals, it is recommended that you do not select **Virtual Surround Sound**, in order to avoid damaging your speakers.

Click **Run Setup Wizard** to change your original startup settings.

Click **About Acer Arcade** to open a page with version and copyright information.

Click **Restore Default Settings** to return the Acer Arcade settings to their default values.

Arcade controls

When watching video clips, movies or slide shows at full screen, two pop-up control panels are shown when you move the pointer. They automatically disappear after several seconds. The "Navigation Controls" panel appears at the top and the "Player Controls" panel appears at the bottom of the screen.

Navigation controls

To return to the Arcade home page, click the **Home** button in the upper-left corner of the window. To go up one folder level while searching for content, click **Up one level**. To return to the previous screen, click the **red arrow**. The buttons in the upper right (minimize, maximize, close) have standard PC behaviors.

To quit Arcade, click the **Close** button in the upper right corner of the window.

Player controls

At the bottom of the window, the player controls — used for video, slide shows, TV, movies and music — are shown. The group on the left provides standard playback controls (play, pause, stop, etc.). The group on the right controls volume (mute and volume up/down).



.....

Note: When playing DVDs and watching TV, there are additional controls added to the right of the volume controls. These are discussed in more detail in the Cinema and TV sections of this guide.

Virtual keyboard

Whenever you are required to enter search information, or name a file, DVD or folder, you can use the onscreen virtual keyboard. You can quickly enter the information you need using the mouse, cursor keys or keyboard.



Background mode

With Acer Arcade you can continue listening to music or watching Live TV while you perform certain other functions. TV, video and music will continue playing in a small window located in the bottom left-hand corner of the screen.

You can press the stop button on the remote or click the onscreen stop icon to stop the playback at any time.



Cinema

If your computer came with a DVD drive, you can play movies from DVDs and video CDs (VCDs) with the Cinema function of Acer Arcade. This player has the features and controls of a typical DVD player.

When you insert a disk into the DVD drive, the movie begins playing automatically. To control the movie, the pop-up player control panel appears at the bottom of the window when you move the pointer.

If more than one optical drive contains a playable disk, click the **Cinema** button on the Home page to open the Cinema content page, then select the disk you'd like to watch from the list on the right.

When viewing DVDs, the following special controls are added to the pop-up panel:

- DVD Menu
- Subtitles
- Language
- Snapshot
- Angle

The disk currently playing will be shown in the area above the list of drives. This page is also displayed when you press the **Stop** button during a movie. The buttons on the left side allow you to resume the movie from the point it was stopped, restart the movie from the beginning, jump to the DVD menu, eject the disk, or go to the "DVD Settings" page.

Settings

To access the settings for Cinema, first click the "Settings" button on the main menu, and then click on Cinema. This allows you to change "Video" and "Language" settings.

The "Settings" control the audio and subtitle output of DVDs.

"Subtitles" selects the default subtitle language for DVDs when available. The factory setting is "Off."

"Closed Captions" turns on the closed captions on DVDs. This function displays captions encoded in the video signal that describe onscreen action and dialog for the hearing impaired. The factory setting is "Off."

"Audio" selects the default language for DVD titles.

"Display Upon Mute" lets you choose whether to turn on the subtitles or captions when you mute the sound for any reason.

Album

Acer Arcade lets you view digital photos individually or as a slide show, from any available drive on your computer. Click the **Album** button on the Arcade Home page to show the Album main page.



The content area on the right shows both individual pictures and folders. **Click** on a folder to open it.

To view a slide show, open the folder containing the pictures you wish to view, then click **Play Slide Show**. The slide show is played at full screen. Use the pop-up control panel to control the slide show.

You can also view a single picture by clicking on it. This opens the picture at full screen.

You can then use the onscreen player controls to zoom in and out, and to pan in four directions.

Editing Pictures

Choose "Edit," and you can "Rotate," "Remove Red Eye," and "Auto Fix" (optimize the brightness and contrast) pictures to improve the appearance of your images.

Slide Show settings

To change Slide Show settings, click the **Advanced** button on the Album page and select "Settings."

"Slide Duration" determines how long each slide is shown before automatically advancing to the next picture in the slide show.

"Slide Show Transition" sets the style of transition used between pictures; you can choose between Motion, Cell, Fade, Random, Wipe, Slide, Page and None modes.

To add background music to a slide show, click on the "Slide Show Music" option. The Slide Show Music page will ask you to choose music from your personal music library.

Click **Load Default Settings** to return your settings to their default values.

Video

To open the Video function, click **Video** on the Arcade Home page.



Note: The Video feature is designed to play back many different kinds of video formats. Refer to the Video help section for a full list of compatible formats. If you want to watch a DVD or VCD, use the "Cinema" function.

Playing a video file

Click **Play** to watch video files. The Video page shows the video files in the content area on the right side. They are organized by folders and a thumbnail image shows the first frame of each video.

To play a video file, click on it. The video will play at full screen. The pop-up control panel will appear at the bottom of the screen when you move the mouse. To return to the Video page, click **Stop**.

Capturing video (TV models only)

Acer Arcade allows you to capture and record video clips from other external devices, such as a DVD player or camcorder.

Click **Capture Device** on the video page and then select the source you are using for your video input. There is a choice between "S-video" and "Composite."

To capture a video clip, you then need to click the red record button in the onscreen controls.

The destination folder can be set from the "Settings" menu.

Clicking on **Advanced** and selecting **Settings** allows you to set the quality of the video captured. You can choose from "Good," "Better" or "Best." Selecting a higher quality results in a larger file when capturing video clips.

Snapshot

Snapshot mode is available in Cinema, Video and TV modes. This function can be used to capture the onscreen image at any time.

A single frame image will be captured and stored in a user designated directory. The destination directory can be changed from the "Settings" menu.

Music

For convenient access to your music collection, click **Music** on the Arcade homepage to open the Music homepage.

Select the folder, CD or category that contains the music you want to listen to. Click **Play** to listen to the entire content from the beginning, or select the song that you want to hear from the list in the content area.

The songs in the folder are shown in the content area, while the left side has controls for "Play," "Shuffle" and "Repeat All." The "Visualize" option allows you to watch computer-generated visuals while you listen to music. When playing music, the control panel at the bottom of the page makes it easy to adjust the volume and control playback.

To rip music from an audio CD, after you have inserted the CD, click **Rip CD**. In the page that opens, select the songs you would like to rip (or click **Select** or **Clear All**), then click **Start Ripping**.

The progress of the ripping operation will be displayed on screen.

You can change the file quality of the ripped tracks by clicking **Settings**.

TV (for selected models)

Arcade allows you to watch TV from your computer. Click the **TV** button on the home page to show the TV main page.

The **Live TV** option plays TV on screen. Press **Escape** at any time to return to Arcade.

When you watch TV, additional buttons appear on the playback controls: **Channel Up** (switches up one channel), **Channel Down** (switches down one channel), **Snapshot** (takes a snapshot of the current frame of video), **TeleText** (opens the TeleText function), and **Record** (records TV content as a video file).

The **Recorded TV** option allows you to view files that you have recorded from the TV. See Recorded TV.

The **Schedule** option lets you set TV recording schedules for later viewing. See Scheduling Recordings.

The **Program Guide** option lets you view program information for all channels. See Program Guide.

The **Find Program** option enables you to search for a specific kind of program.

The **Settings** button opens a page containing TV settings. See TV settings for more information.



.....

Note: For information on setting up and operating the TV mode of Arcade please refer to the separate TV booklet.

Time-shift functionality

Arcade also has a time-shift function that can be enabled. To create an instant replay, Arcade records the TV broadcast as a file, creating a slight lag between the live broadcast and the TV content that you watch. (The instant replay file cannot be saved, however, and you cannot watch this file in the Recorded TV window.) You can navigate forward and backward within the file to create an instant replay or to skip over commercials.



.....

Note: One of your local drives must contain at least 2 GB of free space in order to enable the instant replay function.

Click "||" to pause playback or "▶" to continue watching. Click "◀◀" to rewind or "▶▶" to fast forward. Click "◀" to go to the start of the instant replay recording or click "▶" to go to the end of the instant replay recording.



Note: Since the TV content you watch always lags slightly behind the live TV broadcast, going to the end of the instant replay recording is as close to watching live TV as Arcade permits.

Recorded TV

The "Recorded TV" page shows recorded TV files. A thumbnail image shows the first frame of each file. To **play** a recorded TV file, click it. The video will play at full screen. To return to the TV page, click **Stop**.

For a description of the options on this page, see [Videos](#).

Scheduling recordings

To set a TV recording schedule, click **Schedule**, then **New Schedule**. In the page that opens, select the **Channel** you want to record and the **scheduling Interval**. Set the **Starting Date**, **Starting Time**, and **Ending Time** of the program you want to record. Click **Confirm Schedule** to activate the recording schedule, or **Cancel** to quit without accepting the schedule. Select **Delete Schedule** to remove a recording schedule you have previously created.

Click an existing recording schedule to open it for modification. To change the order in which schedules are displayed, click **Sort by Channel** or **Sort by Date**.

Program guide

Click the **Program Guide** button to view program listing details for each channel. These listings and information are provided by the Electronic Program Guide.

Find program

Clicking the **Find Program** button allows you to search for programs by channel number or category.

TV settings

To change picture settings, click the **TV** button on the "Settings" page or the **Settings** button on the main TV page. There are four types of TV settings: "Signal," "Channel," "Recording" and "Guide" settings.

Signal settings

Click on **Capture Device** to select between an analog or digital input for your TV signal.

Select **TV Source** to choose the source of the signal.

The **Region** option allows you to select the country or region where your cable provider is located.

You can also enable and disable the time-shift function.

Channel settings

If no channel list exists, click **Scan Channels**. Your computer will scan and list the available TV channels. Click **Scan Channels** to rescan and replace your existing channel line-up.

Recording settings

The **Recording Quality** option allows you to set the quality of video recorded from the TV. Selecting a higher quality results in a larger recorded file when recording TV shows.

You can also select the destination for any recorded TV.

Guide settings

Click on **EPG Source** to select the source for your EPG program listings. This will differ depending on your region.

Click **Restore Default Settings** to return your settings to their default values.

Using TeleText functions

For regions with the TeleText service, TeleText can be activated by using the onscreen controller or the remote control.

Pressing the **TeleText** button on the remote will bring up TeleText; press again to bring up transparent mode (the text will have TV pictures in the background), and press once more to return to TV only.

To navigate within the TeleText function, you can:

- Click the color buttons to follow the onscreen color shortcuts.
- Click an onscreen page number to jump to that page.
- Use the number buttons to enter a page number directly.
- Use the up/down buttons on the remote to navigate page numbers, followed by **OK** to select.
- Use the left and right buttons to browse sub-pages.



Note: The snapshot function is available when TeleText is running.

Acer Arcade Deluxe (for selected models)



Note: Acer Arcade Deluxe is available for systems with Windows Media Center.

Acer Arcade Deluxe extends the capabilities of your Windows Media Center-equipped system with a set of Acer utilities designed to make it easy to manage your multimedia files, create your own customized content, and more.

Arcade Deluxe includes the following utilities:

- VideoMagician
- TV Joy (selected models only)
- SportsCap (selected models only)
- DV Wizard
- DVDivine



Remote control (for selected models)

If your computer is bundled with a remote control for use with the Arcade Deluxe software, the table below explains the functions.

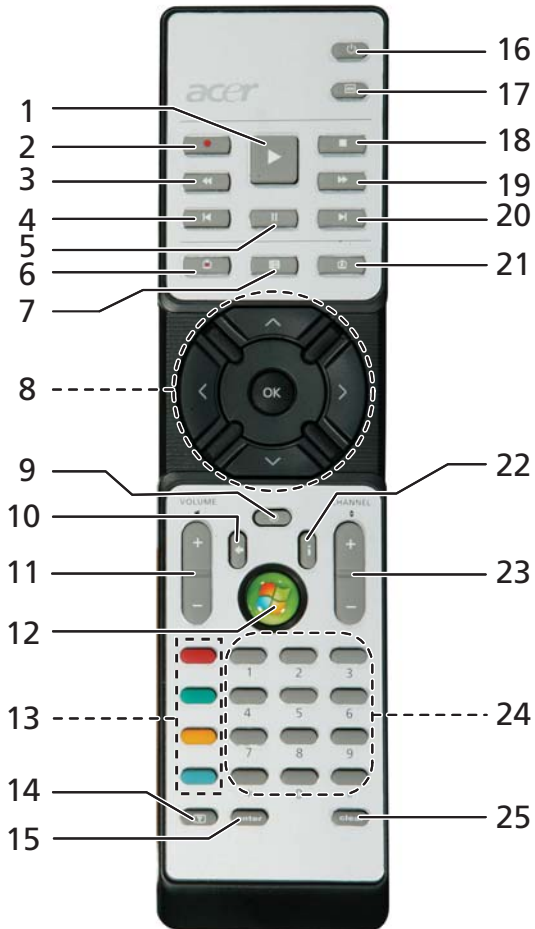

Remote functions

#	Item	Description
1	Play	Play selection
2	Record	Record TV
3	Rewind	Reverse playback or go to previous picture
4	Skip Backward	Skip a section backward
5	Pause	Pause playback
6	Recorded TV	Display Recorded TV page
7	Guide	Display the Guide
8	Navigation/ OK buttons	Navigate and confirm selections
9	Mute	Toggle audio on/off
10	Back	Move up one level in the UI
11	Volume + / -	Increase or decrease the audio playback level
12	Start	Open or close Media Center
13	Color buttons	Teletext shortcut functions*
14	TeleText*	Turn teletext on or off
15	Enter	Make the current input active
16	Power	Put in or wake from Standby mode
17	DVD Menu	Display DVD menu
18	Stop	Stop current playing or recording operation
19	Fast Forward	Speed up playback or go to next picture
20	Skip Forward	Skip a section forward
21	Live TV	Show live TV on current channel
22	Information	Provide information for current selection
23	Channel + / -	Change the current channel
24	0-9 buttons	Enter TV channel or other input
25	Clear	Clear current input

*TeleText regions only.

Starting Acer Arcade Deluxe

You can run the Acer Arcade Deluxe utilities directly from Windows Media Center. To do this, scroll up/down from the Main page to view the Acer Arcade Deluxe utilities list and left/right to select a utility.

To run the Acer Arcade Deluxe utilities outside of Windows Media Center, double-click the Acer Arcade Deluxe icon from the Windows desktop.



.....

Note: For detailed information about specific Acer Arcade Deluxe utilities, use the built-in help files.

VideoMagician

VideoMagician allows you to edit video files (in DAT, DVR-MS, MPG, MPE, AVI, ASF, MPEG, WMV, VOB, MPEG1, and MPEG2 formats) on your computer. VideoMagician offers multiple themes to create exciting movies in just a few simple steps. When you launch VideoMagician to edit a video, the Select Videos page opens.

TV Joy (selected models only)

TV Joy enriches the TV watching experience on your computer. You can enjoy live TV programs, schedule recordings and watch recorded TV shows. When TV Joy is launched, the last channel viewed will be displayed full screen.

SportsCap (selected models only)

SportsCap is a revolutionary way of watching your sports videos. It automatically detects highlights of the most memorable moments in sports from your recorded games.



.....

Note: The sports types available in your version of SportsCap depend on the version and modules installed on your computer.

DV Wizard

DV Wizard provides real-time preview and capture from DV camcorders and webcams to your computer's hard drive or directly burned to DVD. DV Wizard also supports the capture of High Definition video to your computer's hard disk in the DVD format. Attach your DV camcorder or web cam to your computer and then start DV Wizard to begin.

DVDivine

DVDivine is a handy utility for quickly creating DVDs or other discs containing video, pictures, or music. In just a few easy steps, you can design, organize, then burn your disc. When you start DVDivine, the Select Media page appears, allowing you to select the kind of media that you want to include on your disc. You can select Videos, Pictures or Music.

Taking your notebook PC with you

This section gives you tips and hints to consider when moving around or traveling with your computer.

Disconnecting from the desktop

Follow these steps to disconnect your computer from external accessories:

- 1 Save any open files.
- 2 Remove any media, floppy disks or compact disks from the drive(s).
- 3 Shut down the computer.
- 4 Close the display cover.
- 5 Disconnect the cord from the AC adapter.
- 6 Disconnect the keyboard, pointing device, printer, external monitor and other external devices.
- 7 Disconnect the Kensington lock if you are using one to secure the computer.

Moving around

When you are just moving within short distances, for example, from your office desk to a meeting room.

Preparing the computer

Before moving the computer, close and latch the display cover to place it in Sleep mode. You can now safely take the computer anywhere you go within the building. To bring the computer out of Sleep mode, open the display; then press and release the power button.

If you are taking the computer to a client's office or a different building, you may choose to shut down the computer:

Click on **Start, Turn Off Computer**, then click on **Turn Off** (Windows XP).

Or:

You can put the computer in Sleep mode by pressing **<Fn> + <F4>**. Then close and latch the display.

When you are ready to use the computer again, unlatch and open the display; then press and release the power button.



Note: If the Sleep indicator is off, the computer has entered Hibernation mode and is turned off. If the power indicator is off but the Sleep indicator is on, the computer has entered Sleep mode. In both cases, press and release the power button to turn the computer back on. Note that the computer may enter Hibernation mode after being in Sleep mode for a period of time.

What to bring to meetings

If your meeting is relatively short, you probably do not need to bring anything with you other than your computer. If your meeting will be longer, or if your battery is not fully charged, you may want to bring the AC adapter with you to plug in your computer in the meeting room.

If the meeting room does not have an electrical outlet, reduce the drain on the battery by putting the computer in Sleep mode. Press **<Fn> + <F4>** or close the display cover whenever you are not actively using the computer. To resume, open the display (if closed), then press and release the power button.

Taking the computer home

When you are moving from your office to your home or vice versa.

Preparing the computer

After disconnecting the computer from your desktop, follow these steps to prepare the computer for the trip home:

- Check that you have removed all media and compact disks from the drive(s). Failure to remove the media can damage the drive head.
- Pack the computer in a protective case that can prevent the computer from sliding around and cushion it if it should fall.



Caution: Avoid packing items next to the top cover of the computer. Pressure against the top cover can damage the screen.

What to take with you

Unless you have some items at home, take the following items with you:

- AC adapter and power cord
- The printed User's Guide

Special considerations

Follow these guidelines to protect your computer while traveling to and from work:

- Minimize the effects of temperature changes by keeping the computer with you.
- If you need to stop for an extended period of time and cannot carry the computer with you, leave the computer in the trunk of the car to avoid exposing the computer to excessive heat.
- Changes in temperature and humidity can cause condensation. Allow the computer to return to room temperature, and inspect the screen for condensation before turning on the computer. If the temperature change is greater than 10 °C (18 °F), allow the computer to come to room temperature slowly. If possible, leave the computer for 30 minutes in an environment with a temperature between outside and room temperature.

Setting up a home office

If you frequently work on your computer at home, you may want to purchase a second AC adapter for use at home. With a second AC adapter, you can avoid carrying the extra weight to and from home.

If you use your computer at home for significant periods of time, you might also want to add an external keyboard, monitor or mouse.

Traveling with the computer

When you are moving within a larger distance, for instance, from your office building to a client's office building or traveling locally.

Preparing the computer

Prepare the computer as if you were taking it home. Make sure that the battery in the computer is charged. Airport security may require you to turn on your computer when carrying it into the gate area.

What to take with you

Take the following items with you:

- AC adapter
- Spare, fully-charged battery pack(s)
- Additional printer driver files if you plan to use another printer

Special considerations

In addition to the guidelines for taking the computer home, follow these guidelines to protect your computer while traveling:

- Always take the computer as carry-on luggage.
- If possible, have the computer inspected by hand. Airport security X-ray machines are safe, but do not put the computer through a metal detector.
- Avoid exposing floppy disks to hand-held metal detectors.

Traveling internationally with the computer

When you are moving from country to country.

Preparing the computer

Prepare the computer as you would normally prepare it for traveling.

What to bring with you

Bring the following items with you:

- AC adapter
- Power cords that are appropriate for the country to which you are traveling
- Spare, fully-charged battery packs
- Additional printer driver files if you plan to use another printer
- Proof of purchase, in case you need to show it to customs officials
- International Travelers Warranty passport

Special considerations

Follow the same special considerations as when traveling with the computer. In addition, these tips are useful when traveling internationally:

- When traveling in another country, check that the local AC voltage and the AC adapter power cord specifications are compatible. If not, purchase a power cord that is compatible with the local AC voltage. Do not use converter kits sold for appliances to power the computer.
- If you are using the modem, check if the modem and connector is compatible with the telecommunications system of the country you are traveling in.

Securing your computer

Your computer is a valuable investment that you need to take care of. Learn how to protect and take care of your computer.

Security features include hardware and software locks — a security notch and passwords.

Using a computer security lock

The notebook comes with a Kensington-compatible security slot for a security lock.

Wrap a computer security lock cable around an immovable object such as a table or handle of a locked drawer. Insert the lock into the notch and turn the key to secure the lock. Some keyless models are also available.

Using passwords

Passwords protect your computer from unauthorized access. Setting these passwords creates several different levels of protection for your computer and data:

- Supervisor Password prevents unauthorized entry into the BIOS utility. Once set, you must enter this password to gain access to the BIOS utility. See **"BIOS utility" on page 79**.
- User Password secures your computer against unauthorized use. Combine the use of this password with password checkpoints on boot-up and resume from Hibernation for maximum security.
- Password on Boot secures your computer against unauthorized use. Combine the use of this password with password checkpoints on boot-up and resume from Hibernation for maximum security.



Important! Do not forget your Supervisor Password! If you forget your password, please get in touch with your dealer or an authorized service center.

Entering passwords

When a password is set, a password prompt appears in the center of the display screen.

- When the Supervisor Password is set, a prompt appears when you press <F2> to enter the BIOS utility at boot-up.
- Type the Supervisor Password and press <Enter> to access the BIOS utility. If you enter the password incorrectly, a warning message appears. Try again and press <Enter>.
- When the User Password is set and the password on boot parameter is enabled, a prompt appears at boot-up.
- Type the User Password and press <Enter> to use the computer. If you enter the password incorrectly, a warning message appears. Try again and press <Enter>.



.....

Important! You have three chances to enter a password. If you fail to enter the password correctly after three tries, the system halts. Press and hold the power button for four seconds to shut down the computer. Then turn on the computer again, and try again.

Setting passwords

You can set passwords using the BIOS utility.

Expanding through options

Your notebook PC offers you a complete mobile computing experience.

Connectivity options

Ports allow you to connect peripheral devices to your computer as you would with a desktop PC. For instructions on how to connect different external devices to the computer, read the following section.

Fax/data modem

Your computer has a built-in V.92 56 Kbps fax/data modem.



.....
Warning! This modem port is not compatible with digital phone lines. Plugging this modem into a digital phone line will damage the modem.

To use the fax/data modem port, connect a phone cable from the modem port to a telephone jack.

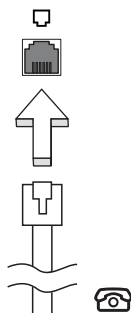

.....
Warning! Please make sure that the cable you use is appropriate for the country in which you are working.

Built-in network feature

The built-in network feature allows you to connect your computer to an Ethernet-based network.

To use the network feature, connect an Ethernet cable from the Ethernet (RJ-45) port on the chassis of the computer to a network jack or hub on your network.

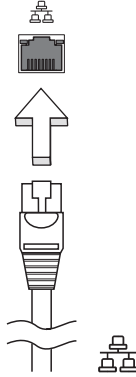

Universal Serial Bus (USB)

The USB 2.0 port is a high-speed serial bus which allows you to connect USB peripherals without taking up precious system resources.

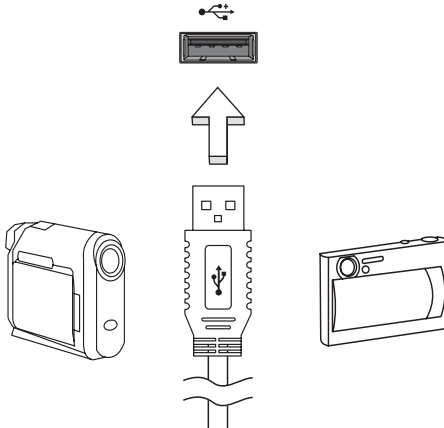

IEEE 1394 port

The computer's IEEE 1394 port allows you to connect to an IEEE 1394-compatible device like a video camera or digital camera. See your video or digital camera's documentation for details.

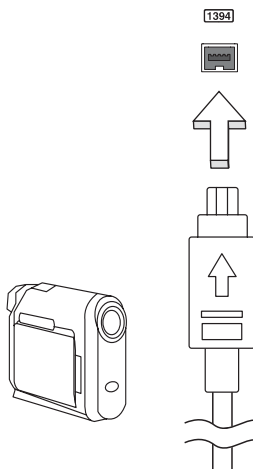

ExpressCard

The ExpressCard is the newest version of the PC Card. It is a smaller and faster interface that further enhances the usability and expandability of your computer.

ExpressCards support a vast number of expansion options, including flash memory card adapters, TV-tuners, Bluetooth connectivity and IEEE 1394B adapters. ExpressCards support USB 2.0 and PCI Express applications.



Important! There are two types, ExpressCard/54 and ExpressCard/34 (54mm and 34mm), each with different functions. Not all ExpressCard slots will support both types. Please refer to your card's manual for details on how to install and use the card, and its functions.

Inserting an ExpressCard

Insert the card into the slot and push gently until it clicks into position.

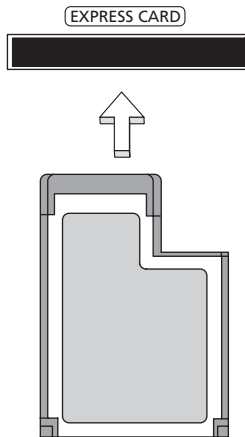

Ejecting an ExpressCard

Before ejecting an ExpressCard:

- 1 Exit the application using the card.
- 2 Left-click on the remove hardware icon on the taskbar and stop the card operation.
- 3 Push the card gently into the slot and release to pop out the card. Then pull the card free from the slot.

Installing memory

Follow these steps to install memory:

- 1 Turn off the computer, unplug the AC adapter (if connected) and remove the battery pack. Then turn the computer over to access its base.
- 2 Remove the screws from the memory cover; then lift up and remove the memory cover.
- 3 **(a)** Insert the memory module diagonally into the slot, then **(b)** gently press it down until it clicks into place.

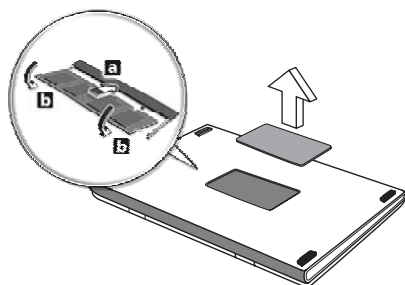

- 4 Replace the memory cover and secure it with the screw.
- 5 Reinstall the battery pack, and reconnect the AC adapter.
- 6 Turn on the computer.

The computer automatically detects and reconfigures the total memory size. Please consult a qualified technician or contact your local Acer dealer.

Connecting your TV and AV-in cables (for selected models)

Follow the instructions below to set up the TV function of your Acer notebook.

PAL/SECAM and NTSC systems

- 1 Plug the PAL/SECAM cable's RF plug into your notebook's RF-in jack.
- 2 Connect the other end to your TV antenna cable, using the NTSC converter if necessary.

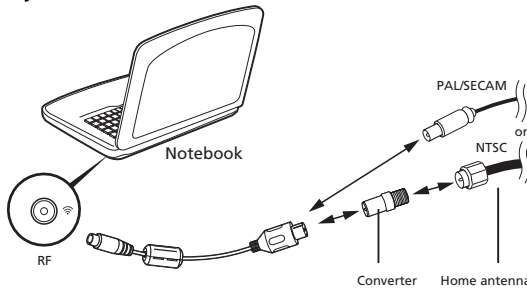

Important! Please ensure you use the correct cable system for your region before attempting to connect the antenna cable.

Acer DVB-T digital antenna

To connect the antenna:

Plug the antenna cable into the RF-in jack of your notebook.

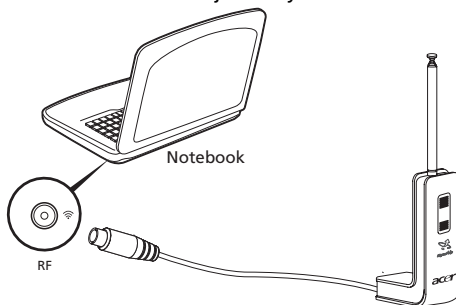

Note: All diagrams are for reference purposes only. Actual equipment may differ in appearance.

To set up the antenna:

- 1 Push gently at the top until the bottom section pops out.
- 2 Pull the bottom up until it is positioned at 90 degrees to the antenna body.

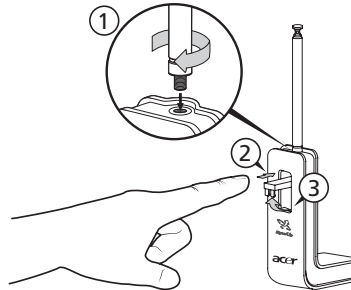

- 3 To ensure good reception, the antenna can be positioned on top of your notebook display using the special clip, as shown below.
- 4 Extend the antenna to improve the quality of the reception.

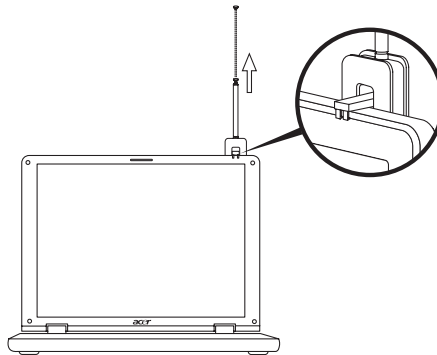

Note: The antenna is only compatible with DVB-T digital TV systems.

A magnet located on the base of the antenna unit also allows you to fix it firmly onto a metal surface for better stability and reception.



Warning! Do not place the magnet near the hard disk drive of your computer. Doing so may damage the drive and/or data.

AV-in cable

The AV-in cable can be used to connect your notebook to a VHS player or camcorder for viewing, capturing and recording video clips.

- 1 Plug the single end of the cable into the AV-in port of your notebook.
- 2 Connect the other ends to the S-video or composite audio/video jacks on your VHS player, camcorder or other compatible device.

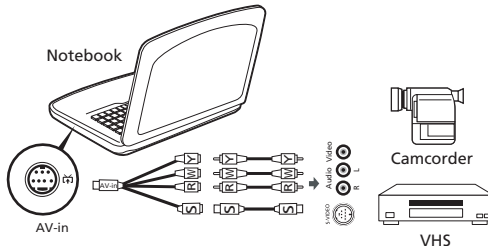

Note: Extension cables may not be necessary. For more details on how to capture TV or video clips please refer to the help file.

BIOS utility

The BIOS utility is a hardware configuration program built into your computer's BIOS.

Your computer is already properly configured and optimized, and you do not need to run this utility. However, if you encounter configuration problems, you may need to run it.

To activate the BIOS utility, press <F2> during the POST; while the notebook PC logo is being displayed.

Boot sequence

To set the boot sequence in the BIOS utility, activate the BIOS utility, then select **Boot** from the categories listed at the top of the screen.

Enable disk-to-disk recovery

To enable disk-to-disk recovery (hard disk recovery), activate the BIOS utility, then select **Main** from the categories listed at the top of the screen. Find **D2D Recovery** at the bottom of the screen and use the <F5> and <F6> keys to set this value to **Enabled**.

Password

To set a password on boot, activate the BIOS utility, then select **Security** from the categories listed at the top of the screen. Find **Password on boot:** and use the <F5> and <F6> keys to enable this feature.

Using software

Playing DVD movies

When the DVD drive module is installed in the optical drive bay, you can play DVD movies on your computer.

- 1 Eject the DVD disk.



Important! When you launch the DVD player for the first time, the program asks you to enter the region code. DVD disks are divided into 6 regions. Once your DVD drive is set to a region code, it will play DVD disks of that region only. You can set the region code a maximum of five times (including the first time), after which the last region code set will remain permanent. Recovering your hard disk does not reset the number of times the region code has been set. Refer to the table below for DVD movie region code information.

- 2 The DVD movie will automatically play after a few seconds.

Region code	Country or region
1	USA, Canada
2	Europe, Middle East, South Africa, Japan
3	Southeast Asia, Taiwan, South Korea
4	Latin America, Australia, New Zealand
5	Former USSR, parts of Africa, India
6	People's Republic of China



Note: To change the region code, insert a DVD movie of a different region into the DVD drive. Please refer to the online help for more information.

Power management

This computer has a built-in power management unit that monitors system activity. System activity refers to any activity involving one or more of the following devices: keyboard, mouse, hard disk, peripherals connected to the computer, and video memory. If no activity is detected for a period of time (called an inactivity timeout), the computer stops some or all of these devices in order to conserve energy.

This computer employs a power management scheme that supports the advanced configuration and power interface (ACPI), which allows for maximum power conservation and maximum performance at the same time. Windows handles all power-saving chores for your computer.

Acer eRecovery Management

Acer eRecovery Management is a tool to quickly backup and restore the system. You can create and save a backup of the current system configuration to hard disk, CD or DVD. You can also backup/restore the factory default image, and reinstall applications and drivers.

Acer eRecovery Management consists of the following functions:

- 1 Create backup
- 2 Burn backup disc
- 3 Restore and recovery

This chapter will guide you through each process.



Note: This feature is only available on certain models. For systems that do not have a built-in optical disc burner, plug in an external optical disc burner before entering Acer eRecovery Management for optical disc-related tasks.

When using Acer eRecovery Management, you may be prompted to enter the Empowering Technology password to proceed. The Empowering Technology password is set using the Empowering Technology toolbar or when first running Acer eLock Management or Acer eRecovery Management.

Create backup

You can easily create full and fast (incremental) backup images of your system configuration to hard disk from the main Acer eRecovery Management screen.



Note: Fast (incremental) Backup is only available after a Full Backup is made.

- 1 Press **<Alt> + <F10>** or select Acer eRecovery Management from the Empowering Technology toolbar to start Acer eRecovery Management.
- 2 In the Acer eRecovery Management window, select the type of backup you want to create using **Full** or **Fast**.
- 3 Follow the instructions on screen to complete the process.

Burn backup disc

Using the **Burn Disc** page of Acer eRecovery Management, you can burn the factory default image, a user backup image, the current system configuration, or an application backup image to CD or DVD.

- 1 Press **<Alt> + <F10>** or select Acer eRecovery Management from the Empowering Technology toolbar to start Acer eRecovery Management.
- 2 Switch to the Burn Disc page by selecting the **Burn Disc** button.
- 3 Select the type of backup (factory default, user, current system, application) you would like to burn to disc. Choosing to burn a user backup will burn your most recently created backup image to disc.
- 4 Follow the instructions on screen to complete the process.



.....

Note: Create a factory default image when you want to burn a bootable disc that contains your computer's entire operating system as it was delivered to you from the factory. If you wish to have a disc that will allow you to browse the contents and install selected drivers and applications, create an application backup image instead — this disc will not be bootable.

Restore and recovery

The restore and recovery features allow you to restore or recover the system from a factory default image, from a user created image, or from previously created CD and DVD backups. You can also reinstall applications and drivers for your Acer system.

- 1 Press **<Alt> + <F10>** or select Acer eRecovery Management from the Empowering Technology toolbar to start Acer eRecovery Management.
- 2 Switch to the restore and recovery page by selecting the **Restore** button.
- 3 Select the backup point you would like to restore from. You can also choose to recover the system from a factory default image, recover from a previously created CD/DVD or reinstall applications and drivers.
- 4 Follow the instructions on screen to complete the process.

Troubleshooting

This chapter shows you how to deal with common system problems. Read it before calling a technician if a problem occurs. Solutions to more serious problems require opening up the computer. Do not attempt to open the computer yourself; contact your dealer or authorized service center for assistance.

Troubleshooting tips

This notebook PC incorporates an advanced design that delivers onscreen error message reports to help you solve problems.

If the system reports an error message or an error symptom occurs, see "Error messages" below. If the problem cannot be resolved, contact your dealer. See **"Requesting service" on page 43**.

Error messages

If you receive an error message, note the message and take the corrective action. The following table lists the error messages in alphabetical order together with the recommended course of action.

Error messages	Corrective action
CMOS battery bad	Contact your dealer or an authorized service center.
CMOS checksum error	Contact your dealer or an authorized service center.
Disk boot failure	Insert a system (bootable) disk into the floppy drive (A:), then press <Enter> to reboot.
Equipment configuration error	Press <F2> (during POST) to enter the BIOS utility, then press Exit in the BIOS utility to reboot.
Hard disk 0 error	Contact your dealer or an authorized service center.
Hard disk 0 extended type error	Contact your dealer or an authorized service center.
I/O parity error	Contact your dealer or an authorized service center.
Keyboard error or no keyboard connected	Contact your dealer or an authorized service center.
Keyboard interface error	Contact your dealer or an authorized service center.
Memory size mismatch	Press <F2> (during POST) to enter the BIOS utility, then press Exit in the BIOS utility to reboot.

If you still encounter problems after going through the corrective measures, please contact your dealer or an authorized service center for assistance. Some problems may be solved using the BIOS utility.

Regulations and safety notices

FCC notice

This device has been tested and found to comply with the limits for a Class B digital device pursuant to Part 15 of the FCC rules. These limits are designed to provide reasonable protection against harmful interference in a residential installation. This device generates, uses, and can radiate radio frequency energy and, if not installed and used in accordance with the instructions, may cause harmful interference to radio communications.

However, there is no guarantee that interference will not occur in a particular installation. If this device does cause harmful interference to radio or television reception, which can be determined by turning the device off and on, the user is encouraged to try to correct the interference by one or more of the following measures:

- Reorient or relocate the receiving antenna.
- Increase the separation between the device and receiver.
- Connect the device into an outlet on a circuit different from that to which the receiver is connected.
- Consult the dealer or an experienced radio/television technician for help.

Notice: Shielded cables

All connections to other computing devices must be made using shielded cables to maintain compliance with FCC regulations.

Notice: Peripheral devices

Only peripherals (input/output devices, terminals, printers, etc.) certified to comply with the Class B limits may be attached to this equipment. Operation with non-certified peripherals is likely to result in interference to radio and TV reception.

Caution

Changes or modifications not expressly approved by the manufacturer could void the user's authority, which is granted by the Federal Communications Commission, to operate this computer.

Operation conditions

This device complies with Part 15 of the FCC Rules. Operation is subject to the following two conditions: (1) this device may not cause harmful interference,

and (2) this device must accept any interference received, including interference that may cause undesired operation.

Notice: Canadian users

This Class B digital apparatus complies with Canadian ICES-003.

Remarque à l'intention des utilisateurs canadiens

Cet appareil numérique de la classe B est conforme à la norme NMB-003 du Canada.

Declaration of Conformity for EU countries

Hereby, Acer, declares that this notebook PC series is in compliance with the essential requirements and other relevant provisions of Directive 1999/5/EC. (Please visit <http://global.acer.com/products/notebook/reg-nb/index.htm> for complete documents.)

Compliant with Russian regulatory certification



ME61

Modem notices

Notice for USA

This equipment complies with Part 68 of the FCC rules. Located on the modem is a label that contains, among other information, the FCC Registration Number and Ringer Equivalence Number (REN) for this equipment. Upon request, you must provide this information to your telephone company.

If your telephone equipment causes harm to the telephone network, the telephone company may discontinue your service temporarily. If possible, they will notify you in advance. But, if advance notice is not practical, you will be notified as soon as possible. You will also be informed of your right to file a complaint with the FCC.

Your telephone company may make changes in its facilities, equipment, operations, or procedures that could affect the proper functioning of your equipment. If they do, you will be notified in advance to give you an opportunity to maintain uninterrupted telephone service.

If this equipment should fail to operate properly, disconnect the equipment from the phone line to determine if it is causing the problem. If the problem is with the equipment, discontinue use and contact your dealer or vendor.



Caution: To reduce the risk of fire, use only No. 26 AWG or larger UL Listed or CSA Certified Telecommunication Line Cord.

TBR 21

This equipment has been approved [Council Decision 98/482/EC - "TBR 21"] for single terminal connection to the Public Switched Telephone Network (PSTN). However, due to differences between the individual PSTNs provided in different countries, the approval does not, of itself, give an unconditional assurance of successful operation on every PSTN termination point. In the event of problems, you should contact your equipment supplier in the first instance.

List of applicable countries

EU member states as of May 2004 are: Belgium, Denmark, Germany, Greece, Spain, France, Ireland, Italy, Luxembourg, the Netherlands, Austria, Portugal, Finland, Sweden, United Kingdom Estonia, Latvia, Lithuania, Poland, Hungary, Czech Republic, Slovak Republic, Slovenia, Cyprus and Malta. Usage allowed in the countries of European Union, as well as Norway, Switzerland, Iceland and Liechtenstein. This device must be used in strict accordance with the regulations and constraints in the country of use. For further information, please contact local office in the country of use.

Notice for Australia

For safety reasons, only connect headsets with a telecommunications compliance label. This includes customer equipment previously labelled permitted or certified.

Notice for New Zealand

- 1 The grant of a Telepermit for any item of terminal equipment indicates only that Telecom has accepted that the item complies with minimum conditions for connection to its network. It indicates no endorsement of the product by Telecom, nor does it provide any sort of warranty. Above all, it provides no assurance that any item will work correctly in all respects with another item of Telepermitted equipment of a different make or model, nor does it imply that any product is compatible with all of Telecom's network services.
- 2 This equipment is not capable, under all operating conditions, of correct operation at the higher speeds for which it is designed. Telecom will accept no responsibility should difficulties arise in such circumstances.
- 3 Some parameters required for compliance with Telecom's Telepermit requirements are dependent on the equipment (PC) associated with this device. The associated equipment shall be set to operate within the following limits for compliance with Telecom's Specifications:
 - a There shall be no more than 10 call attempts to the same number within any 30 minute period for any single manual call initiation, and
 - b The equipment shall go on-hook for a period of not less than 30 seconds between the end of one attempt and the beginning of the next call attempt.
- 4 Some parameters required for compliance with Telecom's Telepermit requirements are dependent on the equipment (PC) associated with this device. In order to operate within the limits for compliance with Telecom's specifications, the associated equipment shall be set to ensure that automatic calls to different numbers are spaced such that there is not less than 5 seconds between the end of one call attempt and the beginning of another.
- 5 This equipment shall not be set up to make automatic calls to Telecom's 111 Emergency Service.
- 6 This device is equipped with pulse dialing while the Telecom standard is DTMF tone dialing. There is no guarantee that Telecom lines will always continue to support pulse dialing.
- 7 Use of pulse dialing, when this equipment is connected to the same line as other equipment, may give rise to bell tinkle or noise and may also cause a false answer condition. Should such problems occur, the user should NOT contact the telecom Fault Service.
- 8 This equipment may not provide for the effective hand-over of a call to another device connected to the same line.
- 9 Under power failure conditions this appliance may not operate. Please ensure that a separate telephone, not dependent on local power, is available for emergency use.

Laser compliance statement

The CD or DVD drive used with this computer is a laser product.
The CD or DVD drive's classification label (shown below) is located on the drive.

CLASS 1 LASER PRODUCT

CAUTION: INVISIBLE LASER RADIATION WHEN OPEN. AVOID EXPOSURE TO BEAM.

APPAREIL A LASER DE CLASSE 1 PRODUIT

LASERATTENTION: RADIATION DU FAISCEAU LASER INVISIBLE EN CAS D'OUVERTURE. EVITER TOUTE EXPOSITION AUX RAYONS.

LUOKAN 1 LASERLAITE LASER KLASSE 1

VORSICHT: UNSICHTBARE LASERSTRAHLUNG, WENN ABDECKUNG GEÖFFNET NICHT DEM STRAHLL AUSSETZEN

PRODUCTO LÁSER DE LA CLASE I

ADVERTENCIA: RADIACIÓN LÁSER INVISIBLE AL SER ABIERTO. EVITE EXPONERSE A LOS RAYOS.

ADVARSEL: LASERSTRÅLING VEDÅBNING SE IKKE IND I STRÅLEN.

VARO! LAVATTAESSA OLET ALTTINA LASERSÄTEILYLLE.

VARNING: LASERSTRÅLNING NÅR DENNA DEL ÅR ÖPPNAD ÅLÅ TUIJOTA SÄTEESEENSTIRRA EJ IN I STRÅLEN

VARNING: LASERSTRÅLNING NAR DENNA DEL ÅR ÖPPNADSTIRRA EJ IN I STRÅLEN

ADVARSEL: LASERSTRÅLING NAR DEKSEL ÅPNESSTIRR IKKE INN I STRÅLEN

LCD pixel statement

The LCD unit is produced with high-precision manufacturing techniques. Nevertheless, some pixels may occasionally misfire or appear as black or red dots. This has no effect on the recorded image and does not constitute a malfunction.

Macrovision copyright protection notice

"U.S Patent Nos. 4,631,603; 4,819,098; 4,907,093; 5,315,448; and 6,516,132."

This product incorporates copyright protection technology that is protected by U.S. patents and other intellectual property rights. Use of this copyright protection technology must be authorized by Macrovision, and is intended for home and other limited viewing uses only unless otherwise authorized by Macrovision. Reverse engineering or disassembly is prohibited.

Radio device regulatory notice



.....

Note: Below regulatory information is for models with wireless LAN and/or Bluetooth only.

General

This product complies with the radio frequency and safety standards of any country or region in which it has been approved for wireless use. Depending on configurations, this product may or may not contain wireless radio devices (such as wireless LAN and/or Bluetooth modules). Below information is for products with such devices.

European Union (EU)

R&TTE Directive 1999/5/EC as attested by conformity with the following harmonized standard:

- **Article 3.1(a) Health and Safety**
 - EN60950-1:2001
 - EN50371:2002
 - EN50360:2002 (Applied to models with 3G function)
- **Article 3.1(b) EMC**
 - EN301 489-1 V1.4.1:2002
 - EN301 489-17 V1.2.1:2002
 - EN301 489-3 V1.4.1:2002 (Applied to models with 27MHz wireless mouse/keyboard)
 - EN301 489-7 V1.2.1:2002 (Applied to models with 3G function)
 - EN301 489-24 V1.2.1:2002 (Applied to models with 3G function)
- **Article 3.2 Spectrum Usages**
 - EN300 328 V1.5.1:2004
 - EN301 893 V1.2.3:2003
 - EN300 220-1 V1.3.1:2000 (Applied to models with 27MHz wireless mouse/keyboard)
 - EN300 220-3 V1.1.1:2000 (Applied to models with 27MHz

wireless mouse/keyboard)

- EN301 511 V9.0.2:2003 (Applied to models with 3G function)
- EN301 908-1 V2.2.1:2003 (Applied to models with 3G function).
- EN301 908-2 V2.2.1:2003 (Applied to models with 3G function).



List of applicable countries

EU member states as of May 2004 are: Belgium, Denmark, Germany, Greece, Spain, France, Ireland, Italy, Luxembourg, the Netherlands, Austria, Portugal, Finland, Sweden, United Kingdom Estonia, Latvia, Lithuania, Poland, Hungary, Czech Republic, Slovak Republic, Slovenia, Cyprus and Malta. Usage allowed in the countries of European Union, as well as Norway, Switzerland, Iceland and Liechtenstein. This device must be used in strict accordance with the regulations and constraints in the country of use. For further information, please contact local office in the country of use.

The FCC RF safety requirement

The radiated output power of the wireless LAN Mini PCI Card and Bluetooth card is far below the FCC radio frequency exposure limits. Nevertheless, the notebook PC series shall be used in such a manner that the potential for human contact during normal operation is minimized as follows:

- 1 Users are requested to follow the RF safety instructions on wireless option devices that are included in the user's manual of each RF option device.



Caution: To comply with FCC RF exposure compliance requirements, a separation distance of at least 20 cm (8 inches) must be maintained between the antenna for the integrated wireless LAN Mini PCI Card built in to the screen section and all persons.

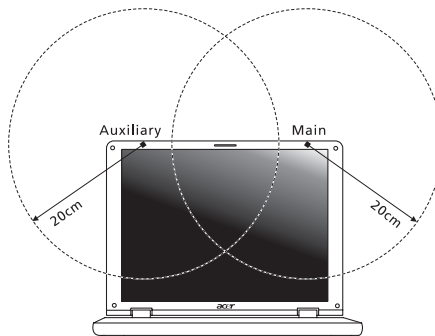

Note: The Acer wireless Mini PCI adapter implements a transmission diversity function. The function does not emit radio frequencies simultaneously from both antennas. One of the antennas is selected automatically or manually (by users) to ensure good quality radiocommunication.

- 2 This device is restricted to indoor use due to its operation in the 5.15 to 5.25 GHz frequency range. FCC requires this product to be used indoors for the frequency range 5.15 to 5.25 GHz to reduce the potential for harmful interference to co-channel Mobile Satellite systems.
- 3 High power radar are allocated as primary users of the 5.25 to 5.35 GHz and 5.65 to 5.85 GHz bands. These radar stations can cause interference with and/or damage this device.
- 4 An improper installation or unauthorized use may cause harmful interference to radio communications. Also any tampering of the internal antenna will void the FCC certification and your warranty.

Canada — Low-power license-exempt radio communication devices (RSS-210)

- a Common information
Operation is subject to the following two conditions:
 1. This device may not cause interference, and
 2. This device must accept any interference, including interference that may cause undesired operation of the device.
 - b Operation in 2.4 GHz band
To prevent radio interference to the licensed service, this device is intended to be operated indoors and installation outdoors is subject to licensing.
 - c Operation in 5 GHz band
- The device for the band 5150-5250 MHz is only for indoor usage to reduce potential for harmful interference to co-channel Mobile Satellite systems.
 - High power radars are allocated as primary users (meaning they have priority) of 5250-5350 MHz and 5650-5850 MHz and these radars could cause interference and/or damage to LELAN (Licence-Exempt Local Area Network) devices.

Federal Communications Commission Declaration of Conformity

This device complies with Part 15 of the FCC Rules. Operation is subject to the following two conditions: (1) This device may not cause harmful interference, and (2) This device must accept any interference received, including interference that may cause undesired operation.

The following local manufacturer/importer is responsible for this declaration:

Product name:	Notebook PC
Model number:	ICW50
Machine type:	Aspire 5520/5220
SKU number:	Aspire 5520/5220-xxxx ("x" = 0 - 9, a - z, or A - Z)
Name of responsible party:	Acer America Corporation
Address of responsible party:	333 West San Carlos St. San Jose, CA 95110 USA
Contact person:	Acer Representative
Tel:	1-254-298-4000
Fax:	1-254-298-4147



Declaration of Conformity

We,

Acer Computer (Shanghai) Limited

3F, No. 168 Xizang medium road, Huangpu District,
Shanghai, China

Contact Person: Mr. Easy Lai

Tel: 886-2-8691-3089 Fax: 886-2-8691-3000

E-mail: easy_lai@acer.com.tw

Hereby declare that:

Product: Personal Computer

Trade Name: Acer

Model Number: ICW50

Machine Type: Aspire 5520/5220

SKU Number: Aspire 5520/5220-xxxxx ("x" = 0~9, a ~ z, or A ~ Z)

Is compliant with the essential requirements and other relevant provisions of the following EC directives, and that all the necessary steps have been taken and are in force to assure that production units of the same product will continue comply with the requirements.

EMC Directive 89/336/EEC as attested by conformity with the following harmonized standards:

- EN55022:1998 + A1:2000 + A2:2003, AS/NZS CISPR22:2002, Class B
- EN55024:1998 + A1:2001 + A2:2003
- EN61000-3-2:2000, Class D
- EN61000-3-3:1995 + A1:2001
- EN55013:2001 + A1:2003 (applied to models with TV function)
- EN55020:2002 + A1:2003 (applied to models with TV function)

Low Voltage Directive 73/23/EEC as attested by conformity with the following harmonized standard:

- **EN60950-1:2001**
- **EN60065:2002 (applied to models with TV function)**

Council Decision 98/482/EC (CTR21) for pan- European single terminal connection to the Public Switched Telephone Network (PSTN).

RoHS Directive 2002/95/EC on the Restriction of the Use of certain Hazardous Substances in Electrical and Electronic Equipment

LCD panel ergonomic specifications

Design viewing distance	500 mm
Design inclination angle	0.0°
Design azimuth angle	90.0°
Viewing direction range class	Class IV
Screen tilt angle	85.0°
Design screen illuminance	<ul style="list-style-type: none"> • Illuminance level: [250 + (250cosα)] lx where $\alpha = 85^\circ$ • Color: Source D65
Reflection class of LCD panel (positive and negative polarity)	<ul style="list-style-type: none"> • Ordinary LCD: Class I • Protective or Acer CrystalBrite™ LCD: Class III
Image polarity	Both
Reference white:	<ul style="list-style-type: none"> • Yn
Pre-setting of luminance and color temperature @ 6500K (tested under BM7)	<ul style="list-style-type: none"> • u'n • v'n
Pixel fault class	Class II

Index

A

- AC adapter
 - caring for xiv
- audio 34
 - adjusting the volume 34
 - troubleshooting 40

B

- battery pack
 - battery-low warning 47
 - caring for xv
 - characteristics 44
 - charging 46
 - checking charge level 46
 - installing 45
 - low conditions 47
 - maximizing life 44
 - optimizing 46
 - removing 46
 - using the first time 44
- BIOS utility 79
- brightness
 - hotkeys 31

C

- caps lock 29
 - on indicator 25
- care
 - AC adapter xiv
 - battery pack xv
 - computer xiv

CD-ROM

- ejecting manually 41
- troubleshooting 41

- charging
 - checking level 46

- cleaning
 - computer xv

- computer
 - caring for xiv
 - cleaning xv
 - disconnecting 65
 - features 15, 37
 - indicators 25
 - keyboards 29
 - moving around 65

- on indicator 25, 26
 - security 69
 - setting up a home office 67
 - taking home 66
 - traveling internationally 68
 - traveling on local trips 67
 - troubleshooting 84
 - turning off xiv

- connections
 - network 72

D

- display
 - hotkeys 31
 - troubleshooting 40
- DVD 80
- DVD movies
 - playing 80

E

- error messages 84
- Euro 32

F

- FAQ. See frequently-asked questions
- frequently-asked questions 40
- front view 17

H

- Hibernation mode
 - hotkey 31
- hotkeys 31

I

- IEEE 1394 port 73

K

- keyboard 29
 - embedded numeric keypad 29
 - hotkeys 31
 - lock keys 29
 - troubleshooting 41
 - Windows keys 30

L

- left view 17

M

- media access
 - on indicator 25

memory
 installing 75
 messages
 error 84
 modem 71

N

network 72
 Notebook Manager
 hotkey 31
 num lock 29
 on indicator 25
 numeric keypad
 embedded 29

P

password 69
 types 69
 ports 71
 printer
 troubleshooting 41
 problems 40
 CD-ROM 41
 display 40
 keyboard 41
 printer 41
 startup 40
 troubleshooting 84

Q

questions
 setting location for modem use
 41

S

safety

 CD or DVD 90
 modem notices 87
 scroll lock 29
 security
 keylock 33, 69
 passwords 69
 speakers
 hotkey 31
 troubleshooting 40
 support
 information 43

T

touchpad 27
 hotkey 31
 using 27– 28
 travel
 international flights 68
 local trips 67
 troubleshooting 84
 tips 84

U

universal serial bus 72

V

view
 front 18
 left 18
 rear 19
 right 19
 volume
 adjusting 34

W

Windows keys 30