

# *Extensa 4100 Series*

User's Guide

Copyright © 2005. Acer Incorporated.  
All Rights Reserved.

Extensa 4100 Series User's Guide  
Original Issue: January 2005

Changes may be made periodically to the information in this publication without obligation to notify any person of such revision or changes. Such changes will be incorporated in new editions of this manual or supplementary documents and publications. This company makes no representations or warranties, either expressed or implied, with respect to the contents hereof and specifically disclaims the implied warranties of merchantability or fitness for a particular purpose.

Record the model number, serial number, purchase date, and place of purchase information in the space provided below. The serial number and model number are recorded on the label affixed to your computer. All correspondence concerning your unit should include the serial number, model number, and purchase information.

No part of this publication may be reproduced, stored in a retrieval system, or transmitted, in any form or by any means, electronic, mechanical, photocopy, recording, or otherwise, without the prior written permission of Acer Incorporated.

Extensa 4100 Series Notebook Computer

Model Number : \_\_\_\_\_

Serial Number: \_\_\_\_\_

Purchase Date: \_\_\_\_\_

Place of Purchase: \_\_\_\_\_

Acer and the Acer logo are registered trademarks of Acer Incorporated. Other company's product names or trademarks are used herein for identification purposes only and belong to their respective companies.

# First things first

We would like to thank you for making the Extensa series of notebook computers your choice for your mobile computing needs.

## Your guides

To help you use your Extensa, we have designed a set of guides:



First off, the **Just for starters...** poster helps you get started with setting up your computer.



The **User's guide** introduces you to the many ways your computer can help you be more productive. This guide provides clear and concise information about the computer, so read it thoroughly.

If you ever need to print out a copy, this User's guide is also available in Portable Document Format (PDF). Follow these steps:

- 1 Click on **Start, All Programs, AcerSystem**.
- 2 Click on **AcerSystem User's guide**.

**Note:** Viewing the file requires Adobe Acrobat Reader be installed. For instructions on how to use Adobe Acrobat Reader, access the **Help and Support** menu.

# Basic care and tips for using your computer

## Turning your computer on and off

To turn on the computer, simply press and release the power button below the LCD screen beside the launch keys. See **“Front view” on page 1** for the location of the power button.

To turn the power off, do any of the following:

- Use the Windows shutdown command

Click on **Start, Turn Off Computer**; then click on **Turn Off**.

- Use the power button



.....

**Note:** You can also use the power button to perform power management functions. See **“Moving around with your Notebook PC” on page 29**.

- Use the customized functions for power management

You can also shut down the computer by closing the display cover, or by pressing the sleep hot key (**Fn-F4**). See **“Moving around with your Notebook PC” on page 29**.



.....

**Note:** If you cannot power off the computer normally, press and hold the power button for more than four seconds to shut down the computer. If you turn off the computer and want to turn it on again, wait at least two seconds before powering up.

## Taking care of your computer

Your computer will serve you well if you take care of it.

- Do not expose the computer to direct sunlight. Do not place it near sources of heat, such as a radiator.
- Do not expose the computer to temperatures below 0°C (32°F) or above 50°C (122°F).
- Do not subject the computer to magnetic fields.
- Do not expose the computer to rain or moisture.
- Do not spill water or any liquid on the computer.
- Do not subject the computer to heavy shock and vibration.

- Do not expose the computer to dust and dirt.
- Never place objects on top of the computer to avoid damaging the computer.
- Do not slam the computer display when you close it.
- Never place the computer on uneven surfaces.

## Taking care of your AC adapter

Here are some ways to take care of your AC adapter:

- Do not connect the adapter to any other device.
- Do not step on the power cord or place heavy objects on top of it. Carefully route the power cord and any cables away from personal traffic.
- When unplugging the power cord, do not pull on the cord itself but pull on the plug.
- The total ampere ratings of the equipment plugged in should not exceed the ampere rating of the cord if you are using an extension cord. Also, the total current rating of all equipment plugged into a single wall outlet should not exceed the fuse rating.

## Taking care of your battery pack

Here are some ways to take care of your battery pack:

- Use only batteries of the same kind as replacements. Turn the power off before removing or replacing batteries.
- Do not tamper with batteries. Keep them away from children.
- Dispose of used batteries according to local regulations. Recycle if at all possible.

## Cleaning and servicing

When cleaning the computer, follow these steps:

- 1** Power off the computer and remove the battery pack.
- 2** Disconnect the AC adapter.
- 3** Use a soft cloth moistened with water. Do not use liquid or aerosol cleaners.

If any of the following occurs:

- The computer has been dropped or the body has been damaged.
- The computer does not operate normally.

Please refer to **“Frequently-asked questions” on page 53.**

### Caution

Changes or modifications not expressly approved by the manufacturer could void the user's authority, which is granted by the Federal Communications Commission, to operate this computer.

### Operation conditions

This device complies with Part 15 of the FCC Rules. Operation is subject to the following two conditions: (1) this device may not cause harmful interference, and (2) this device must accept any interference received, including interference that may cause undesired operation.

Users are requested to follow the RF safety instructions on wireless option devices that are included in the user's manual of each RF option device.

An improper installation or unauthorised use may cause harmful interference to radio communications. Also any tampering of the internal antenna will void the FCC certification and your warranty.

To prevent radio interference to the licensed service, this device is intended to be operated indoors and installation outdoors is subject to licensing. For more information about our products, services, and support information, please visit our website: <http://global.acer.com/>.

First things first	iii
Your guides	iii
Basic care and tips for using your computer	iv
Turning your computer on and off	iv
Taking care of your computer	iv
Taking care of your AC adapter	v
Taking care of your battery pack	v
Cleaning and servicing	v
An Extensa tour	1
Front view	1
Closed front view	3
Left view	5
Right view	6
Rear view	7
Bottom view	8
Specifications	9
Indicators	12
Using the keyboard	14
Lock keys	14
Embedded numeric keypad	15
Windows keys	16
Hot keys	17
Special Keys	19
The Euro symbol	19
The US dollar sign	19
Launch keys	20
Touchpad	21
Touchpad basics	21
Ejecting the optical (CD or DVD) drive tray	23
Using a computer security lock	24
Audio	25
Adjusting the volume	25
Using system utilities	26
Acer eManager	26
Launch Manager	27
Acer GridVista	28
Moving around with your Notebook PC	29
Disconnecting from the desktop	29
Moving around	29
Preparing the computer	29
What to take to short meetings	30
What to bring to long meetings	30
Taking the computer home	30
Preparing the computer	30

# Contents

What to take with you	31
Special considerations	31
Setting up a home office	32
Traveling with the computer	32
Preparing the computer	32
What to take with you	32
Special considerations	32
Traveling internationally with the computer	33
Preparing the computer	33
What to bring with you	33
Special considerations	33
Securing your computer	34
Using a computer security lock	34
Using passwords	34
Entering passwords	35
Setting passwords	35
Expanding through options	37
Connectivity options	37
Fax/Data modem	37
Built-in network feature	38
Fast Infrared	38
Universal Serial Bus	39
IEEE 1394 port	39
PC Card slot	40
BIOS Utility	42
Boot sequence	42
Disc to Disc Recovery enable	42
Password	42
Using software	43
Playing DVD movies	43
Power management	44
	44
Acer eRecovery	45
Create backup	45
Restore from backup	46
Create factory default image CD	46
Re-install bundled software without CD	47
Change password	47
Acer disc-to-disc recovery	48
Multilingual operating system installation	48
Restore without a Recovery CD	48



Troubleshooting my computer	51
Frequently-asked questions	53
Troubleshooting tips	56
Error messages	56
Requesting service	57
International Traveler's Warranty (ITW)	57
Before you call	58
Appendix A	
Regulation & safety notices	59



# An Extensa tour

After setting up your computer as illustrated in the **Just for Starters...** poster, let us show you around your new Extensa computer.

## Front view

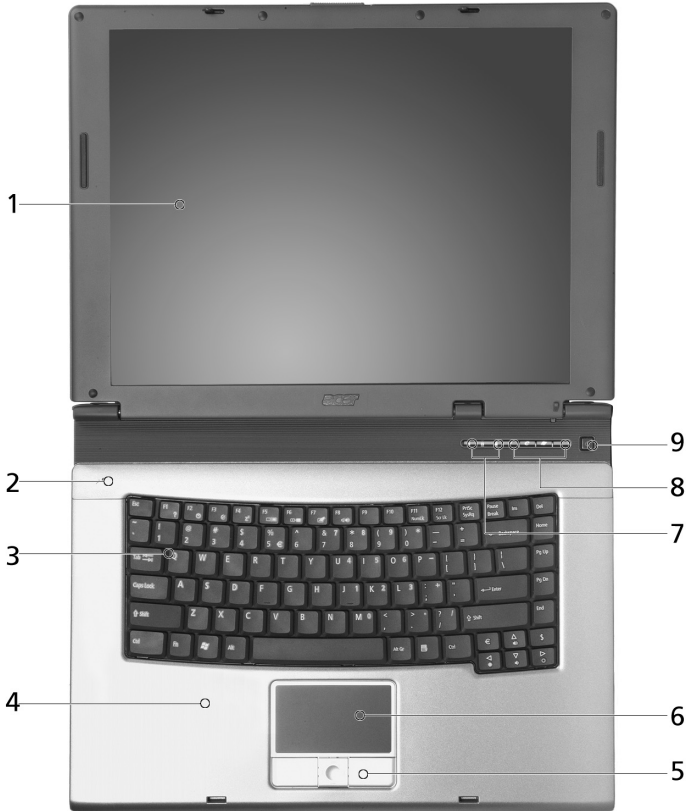







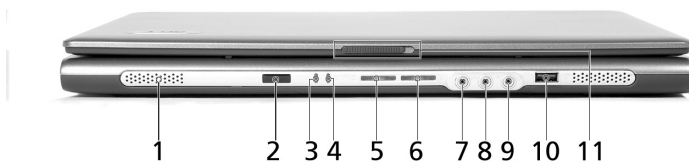

#	Item	Description
1	Display screen	Also called Liquid-Crystal Display (LCD), displaying computer output.
2	Microphone	Internal microphone for sound recording.

#	Item	Description
3	Keyboard	Inputs data into your computer.
4	Palmrest	Comfortable support area for your hands when you use the computer.
5	Click buttons (Left, center and right)	The left and right buttons function like the left and right mouse buttons; the center button serves as a 4-way scroll button.
6	Touchpad	Touch-sensitive pointing device which functions like a computer mouse.
7	Status indicators	Light-Emitting Diodes (LEDs) that turn on and off to show the status of the computer's functions and components.
8	Launch keys	Buttons for launching frequently used programs. See " <b>Launch keys</b> " on page 20 for more details.
9	Power button	Turns the computer on and off.

## Closed front view



#	Item	Description
1	Speakers	Left and right speakers deliver stereo audio output.
2	Infrared port 	Interfaces with infrared devices (e.g., infrared printer and IR-aware computer).
3	Power indicator 	Lights when the computer is on.
4	Battery indicator 	Lights when the battery is being charged.
5	Bluetooth communication button/indicator (for selected models) 	Press to enable/disable Bluetooth function. Lights to indicate the status of Bluetooth communications.

#	Item	Description
6	Wireless communication button/indicator  	Press to enable/disable Wireless function. Lights to indicate the status of wireless LAN communications. (manufacturing option)
7	Line-in jack  	Accepts audio line-in devices (e.g., audio CD player, stereo walkman).
8	Mic-in jack  	Accepts inputs from external microphones.
9	Speaker/Line-Out/Headphone jack  	Connects to audio line-out devices (e.g., speakers, headphones).
10	USB 2.0 port  	Connects to Universal Serial Bus (USB) 2.0 devices (e.g., USB mouse, USB camera).
11	Latch	Locks and releases the lid.

## Left view

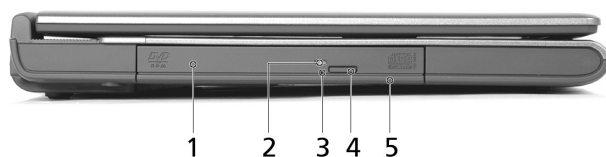







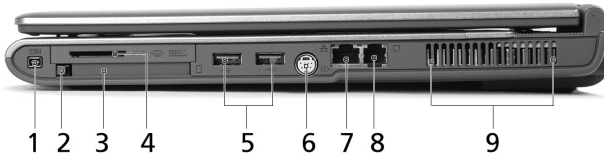

#	Item	Description
1	Optical drive	Internal optical drive; accepts CDs or DVDs depending on the optical drive type.
2	LED indicator	Lights up when the optical drive is active.
3	Emergency eject hole	Ejects the optical drive tray when the computer is turned off
4	Optical drive eject button	Ejects the optical drive tray from the drive.
5	AcerMedia bay (for selected models)	Houses an AcerMedia drive module.



**Note:** The positions of the AcerMedia indicator, eject button and emergency eject hole may differ depending on the optical drive module installed.

## Right view





#	Item	Description
1	IEEE 1394 port 	Connects to IEEE 1394 devices.
2	PC Card slot eject button	Ejects the PC Card from the slot.
3	PC Card slot 	Connects to one Type II CardBus PC Card.
4	4-in-1 card reader (for selected models) 	Accepts MS, MS PRO, MMC and SD card. <b>Note:</b> The 4-in-1 card reader is a manufacturing option, subject to configuration. Only one card can operate at any given time.
5	Two USB 2.0 ports 	Connect to Universal Serial Bus (USB) 2.0 devices (e.g., USB mouse, USB camera).
6	S-video port 	Connects to a television or display device with S-video input.
7	Network jack 	Connects to an Ethernet 10/100/1000-based network (for selected models).
8	Modem jack 	Connects to a phone line.
9	Ventilation slots	Enable the computer to stay cool, even after prolonged use.



## Rear view



#	Item	Description
1	Power jack 	Connects to an AC adapter.
2	External display port 	Connects to a display device (e.g., external monitor, LCD projector).
3	Security keylock 	Connects to a Kensington-compatible computer security lock.

## Bottom view



#	Item	Description
1	Hard disk bay	Houses the computer's hard disk (secured by a screw).
2	AcerMedia bay release latch (for selected models)	Unlatches the AcerMedia drive for removal of drive.
3	AcerMedia bay (for selected models)	Houses an AcerMedia drive module.
4	Battery release latch	Unlatches the battery to remove the battery pack.
5	Battery bay	Houses the computer's battery pack.
6	Battery lock	Locks the battery in place.
7	Cooling fan	Helps keep the computer cool. <b>Note:</b> Do not cover or obstruct the opening of the fan.
8	Memory compartment	Houses the computer's main memory and Mini PCI Card.

# Specifications

## Microprocessor

- Intel® Pentium® M Processor at 1.5 ~ 2.13 GHz or higher
- Intel® Celeron® M Processor at 1.3 ~ 1.6 GHz or higher

## Memory

- 256/512 MB of DDR333 SDRAM standard, upgradeable to 2048 MB with dual soDIMM modules
- 512 KB flash ROM BIOS

## Data storage

- One 40 GB and above E-IDE hard disk (2.5", 9.5mm, UltraDMA-100)
- One internal optical drive, or one 5.25-inch internal removable optical drive (AcerMedia bay, for selected models)
- 4-in-1 Card Reader (for selected models)

## Display and video

- Thin-Film Transistor (TFT) displaying at:
  - 15.0" XGA (1024x768)
  - 15.4" WXGA (1280x800)
  - 15.0" SXGA+ (1400x1050)
- ATI MOBILITY™ RADEON™ X600 with 64/128 MB of video memory (for selected models)
- ATI MOBILITY™ RADEON™ X700 with 64/128 MB of video memory (for selected models)
- Simultaneous LCD and CRT display support
- Dual independent display
- "Automatic LCD dim" feature that automatically decides the best settings for your display and conserves power

## Connectivity

- Integrated 10/100/1000 Mbps Fast Ethernet connection (1000Mbps for selected models)
- Built-in 56Kbps fax/data modem
- Three Universal Serial Bus (USB) 2.0 ports

- InviLink™ 802.11b/g or 802.11a/b/g dual-band tri-mode Wireless LAN (for selected models)
- Bluetooth® (for selected models)

### Audio

- 16-bit AC'97 stereo audio
- Dual speakers and one internal microphone
- Separate audio ports for headphone-out, line-in and microphone-in devices

### Keyboard and pointing device

- 88/89-key Windows keyboard
- Ergonomically-centered touchpad pointing device with scroll function
- Acer FineTouch™ keyboard with a 5-degree curve

### I/O ports

- One Type II PC Card slot
- One RJ-11 phone jack (V.92, 56Kbps modem)
- One RJ-45 network jack
- One DC-in jack (AC adapter)
- One external monitor port
- One speaker/headphone-out jack
- One audio line-in jack
- One microphone-in jack
- One Infrared (FIR) port
- One IEEE 1394 port
- One S-video TV-out port
- Three USB 2.0 ports
- 4-in-1 MS/MS Pro/MMC/SD card reader (for selected models)

### Weight (with battery)

- 6.6 lbs (3 kg)

## Dimensions

- 360 (W) x 273 (D) x 27/32 (H) mm

## Environment

- Temperature:
  - Operating: 5°C ~ 35°C
  - Non-operating: -20°C ~ 65°C
- Humidity (non-condensing):
  - Operating: 20% ~ 80% RH
  - Non-operating: 20% ~ 80% RH

## System

- Microsoft® Windows® XP Home/Pro/MCE (MCE for selected models)
- ACPI 1.0b support
- DMI 2.0-compliant
- Wi-Fi®-compliant
- CCX compliant (for selected models)

## Power

- 8-cell (65W) or 4-cell (32W) Li-ion battery pack
- 65W AC adapter 19V 3.42A

## Options

- 256MB/512MB/1GB memory upgrade module
- Additional 65W AC adapter
- Addition Li-ion battery pack
- Additional hard disk
- USB floppy drive
- Second hard disk (AcerMedia bay, for selected models)
- Second 6-cell battery pack (AcerMedia bay, for selected models)





.....

Note: The specifications listed above are for reference only. The exact configuration of your PC depends on the model purchased.

# Indicators



The computer has three easy-to-read status icons on the upper-right above the keyboard.



Icon	Function	Description
	Caps Lock	Lights when Caps Lock is activated.
	Num Lock	Lights when Num Lock is activated.
	Media activity	Lights when the hard disk or optical drive is active.

In addition, there are two indicators at the front panel. Even when the cover is closed, the state or features can still be seen.



Icon	Function	Description
	Power	Lights when the computer is on.
	Battery indicator	Lights when the battery is being charged.



- .....
1. Charging: the light shows amber when the battery is charging.
  2. Fully charged: light shows green when in AC mode.

# Using the keyboard

The keyboard has full-sized keys and an embedded keypad, separate cursor keys, two Windows keys and twelve function keys.

## Lock keys

The keyboard has three lock keys which you can toggle on and off.

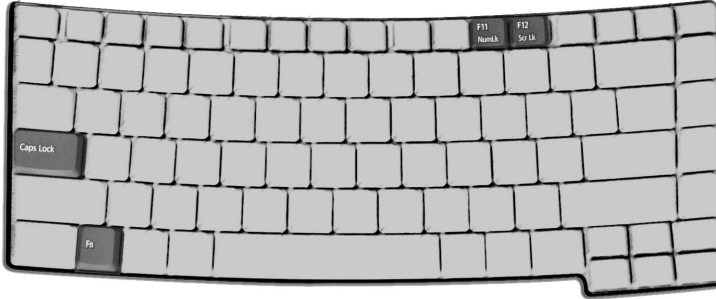

Lock Key	Description
Caps Lock	When Caps Lock is on, all alphabetic characters typed are in uppercase.
Num Lock (Fn-F11)	When Num Lock is on, the embedded keypad is in numeric mode. The keys function as a calculator (complete with the arithmetic operators +, -, *, and /). Use this mode when you need to do a lot of numeric data entry. A better solution would be to connect an external keypad.
Scroll Lock (Fn-F12)	When Scroll Lock is on, the screen moves one line up or down when you press the up or down arrow keys respectively. Scroll Lock does not work with some applications.



## Embedded numeric keypad

The embedded numeric keypad functions like a desktop numeric keypad. It is indicated by small characters located on the upper right corner of the keycaps. To simplify the keyboard legend, cursor-control key symbols are not printed on the keys.









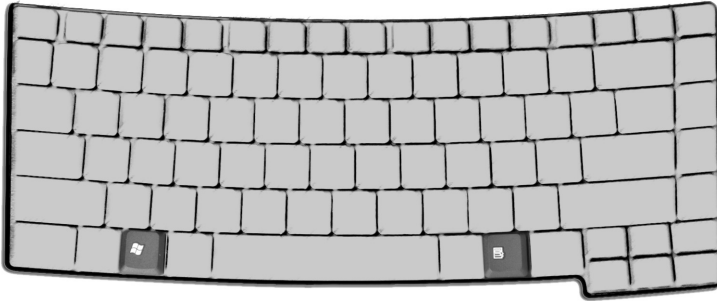



Desired Access	Num Lock On	Num Lock Off
Number keys on embedded keypad	Type numbers in a normal manner.	
Cursor-control keys on embedded keypad	Hold <b>Shift</b> while using cursor-control keys.	Hold <b>Fn</b> while using cursor-control keys.
Main keyboard keys	Hold <b>Fn</b> while typing letters on embedded keypad.	Type the letters in a normal manner.

# Windows keys

The keyboard has two keys that perform Windows-specific functions.





Key	Description
Windows key 	Pressed alone, this key has the same effect as clicking on the Windows Start button; it launches the Start menu. It can also be used with other keys to provide a variety of functions: <ul style="list-style-type: none"> <li> + <b>Tab</b>      Activates the next Taskbar button.</li> <li> + <b>E</b>            Opens the My Computer window.</li> <li> + <b>F1</b>            Opens Help and Support.</li> <li> + <b>F</b>             Opens the Find: All Files dialog box.</li> <li> + <b>M</b>            Minimizes all windows.</li> <li><b>Shift</b> +  + <b>M</b>      Undoes the minimize all windows (  + <b>M</b> ) action.</li> <li> + <b>R</b>            Opens the Run dialog box.</li> </ul>
Application key 	This key has the same effect as clicking the right mouse button; it opens the application's context menu.









# Hot keys

The computer employs hot keys or key combinations to access most of the computer's controls like screen brightness, volume output and the BIOS Utility.

To activate hot keys, press and hold the **Fn** key before pressing the other key in the hot key combination.



Hot Key	Icon	Function	Description
Fn-F1	?	Hot key help	Displays help on hot keys.
Fn-F2		eSetting	Launches the eSetting in the eManager set by the Acer Empowering Key "e". See " <b>Acer eManager</b> " on page 26.
Fn-F3		ePowerManagement (ePM)	Launches the ePowerManagement in the eManager set by the Acer Empowering Key "e". See " <b>Acer eManager</b> " on page 26.
Fn-F4	Z	Sleep	Puts the computer in Sleep mode.

Hot Key	Icon	Function	Description
<b>Fn-F5</b>		Display toggle	Switches display output between the display screen, external monitor (if connected) and both the display screen and external monitor.
<b>Fn-F6</b>		Screen blank	Turns the display screen backlight off to save power. Press any key to return.
<b>Fn-F7</b>		Touchpad toggle	Turns the internal touchpad on and off.
<b>Fn-F8</b>		Speaker toggle	Turns the speakers on and off.
<b>Fn-↑</b>		Volume up	Increases the sound volume.
<b>Fn-↓</b>		Volume down	Decreases the sound volume.
<b>Fn-→</b>		Brightness up	Increases the screen brightness.
<b>Fn-←</b>		Brightness down	Decreases the screen brightness.

# Special Keys

You can locate the Euro symbol and US dollar sign at the upper-center and/or bottom-right of your keyboard. To type:

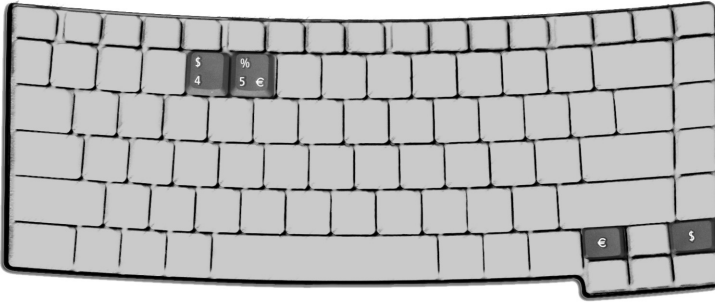

## The Euro symbol

- 1 Open a text editor or word processor.
- 2 Either directly press the **Euro** symbol at the bottom-right of the keyboard, or hold **Alt Gr** and then press the **Euro** symbol at the upper-center of the keyboard.

## The US dollar sign

- 1 Open a text editor or word processor.
- 2 Either directly press the **dollar** sign at the bottom-right of the keyboard, or hold **Shift** and then press the **dollar** sign at the upper-center of the keyboard.



.....  
**Note:** Some fonts and software do not support the Euro symbol. Please refer to [www.microsoft.com/typography/faq/faq12.htm](http://www.microsoft.com/typography/faq/faq12.htm) for more information.

## Launch keys

Located at the upper-right above the keyboard are four buttons. These buttons are called launch keys. They are designated as the mail, Web browser, Empowering Key " *e* " and programmable keys.

Press the Empowering Key " *e* " to run the Acer eManager. Please see "**Acer eManager**" on page 26. The mail and Web browser are default for Email and Internet programs, but can be reset by users. To set the Web browser, mail and programmable keys, run the Acer Launch Manager. See "**Launch Manager**" on page 27.



Launch key	Default application
Mail	Email application (User-programmable)
Web browser	Internet browser application (User-programmable)
<i>e</i>	eManager (User-programmable)
P	User-programmable

# Touchpad

The built-in touchpad is a pointing device that senses movement on its surface. This means the cursor responds as you move your finger on the surface of the touchpad. The central location on the palmrest provides optimum comfort and support.



## Touchpad basics

The following items teach you how to use the touchpad:



- Move your finger across the touchpad to move the cursor.
- Press the left **(1)** and right **(3)** buttons located on the edge of the touchpad to do selection and execution functions. These two buttons are similar to the left and right buttons on a mouse. Tapping on the touchpad is the same as clicking the left button
- Use the 4-way scroll **(2)** button to scroll up or down and move left or right a page. This button mimics your cursor pressing on the right scroll bar of windows applications.

Function	Left button	Right button	Tap
Execute	Click twice quickly.		Tap twice (at the same speed as double-clicking a mouse button).
Select	Click once.		Tap once.
Drag	Click and hold, then use finger to drag the cursor on the touchpad.		Tap twice (at the same speed as double-clicking a mouse button); hold finger to the touchpad on the second tap and drag the cursor.
Access context menu		Click once.	



**Note:** Keep your fingers dry and clean when using the touchpad. Also keep the touchpad dry and clean. The touchpad is sensitive to finger movement, hence, the lighter the touch, the better the response. Tapping harder will not increase the touchpad's responsiveness.



## Ejecting the optical (CD or DVD) drive tray

To eject the optical drive tray when the computer is turned on, press the drive eject button.



When the power is off, you can eject the drive tray using the emergency eject hole.

## Using a computer security lock

A security keylock notch, located on the rear of the computer, lets you connect a Kensington-compatible computer security lock.

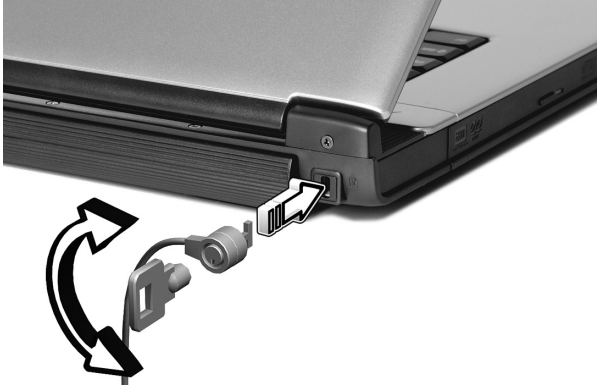

Wrap a computer security lock cable around an immovable object such as a table or handle of a locked drawer. Insert the lock into the notch and turn the key to secure the lock. Some keyless models are also available.

# Audio

The computer comes with 16-bit high-fidelity AC'97 stereo audio, and dual stereo speakers.



## Adjusting the volume

Adjusting the volume on the computer is as easy as pressing some buttons. See **"Hot keys"** on page 17 for more information on adjusting the speaker volume.

# Using system utilities

## Acer eManager

Innovative Acer eManagement software is designed for easy access to frequently used functions. At the press of Acer Empowering Key “*e*”, the Acer eManager user interface appears, featuring four main settings — **Acer eSetting**, **Acer ePresentation**, **Acer ePowerManagement** and **Acer eRecovery**.



To set the Acer Empowering Key, see “**Launch keys**” on page 20.



**Acer eSetting** is an easy way to manage the settings and security of your PC.



**Acer ePresentation** takes the hassle out of making presentations.



**Acer ePowerManagement** provides a central location from where to control all your PC’s power schemes and maximise battery life.



**Acer eRecovery** backs up your files preventing data loss in the event of a system crash.

## Launch Manager

Launch Manager allows you to set the four launch keys located above the keyboard. **“Launch keys” on page 20** for the location of the launch keys.

You can access the Launch Manager by clicking on **Start, All Programs, and then Launch Manager** to start the application.

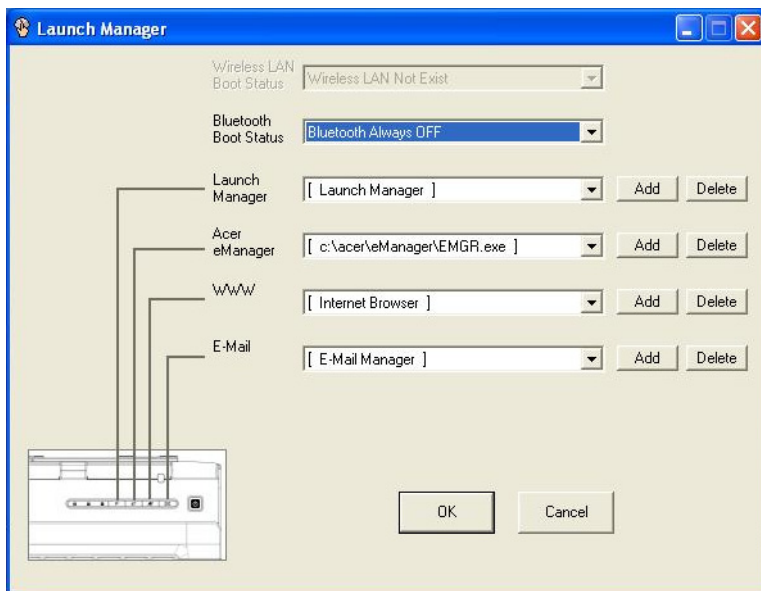

# Acer GridVista

Acer GridVista is a handy utility that offers four pre-defined display settings for users to view multiple windows on the same screen. To access this function, please go to **"Start"->"All Programs"** and click on **"Acer GridVista"**. You may choose any one of the four display settings indicated below:



Double (Vertical), Triple (Major at left), Triple (Major at right), or Quad

**GridVista** is simple to set up.

- 1 Run GridVista and select your preferred screen configuration from the taskbar.
- 2 Drag and drop each window into the appropriate grid.
- 3 Enjoy the convenience of a well-organized desktop.

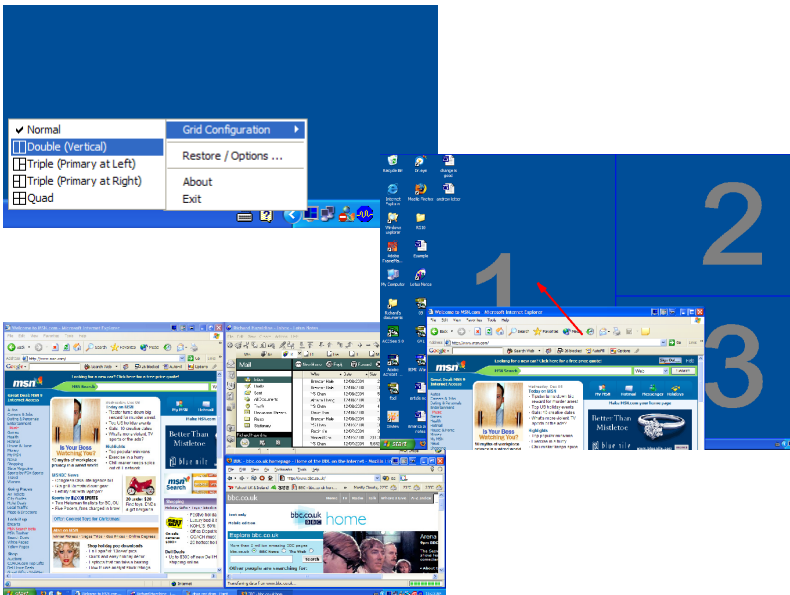

# Moving around with your Notebook PC

This section gives you tips and hints to consider when moving around or traveling with your computer.

## Disconnecting from the desktop

Follow these steps to disconnect your computer from external accessories:

- 1 Save your work in progress.
- 2 Remove any media, floppy discs or compact discs, from the drive(s).
- 3 Shut down the computer.
- 4 Close the display cover.
- 5 Disconnect the cord from the AC adaptor.
- 6 Disconnect the keyboard, pointing device, printer, external monitor, and other external devices.
- 7 Disconnect the Kensington lock if you are using one to secure the computer.

## Moving around

When you are just moving within short distances, for example, from your office desk to a meeting room.

### Preparing the computer

Before moving the computer, close and latch the display cover to place it in Sleep mode. You can now safely take the computer anywhere you go within the building. To bring the computer out of Sleep mode, open the display; then press and release the power button.

If you are taking the computer to a client's office or a different building, you may choose to shut down the computer:

- 1 Click on **Start, Shut Down...** or **Turn off Computer** (Windows XP).

- or -

you can put the computer in Sleep mode by pressing <Fn>+<F4>. Then close and latch the display.

When you are ready to use the computer again, unlatch and open the display; then press and release the power button.



**Note:** If the Sleep indicator is off, the computer has entered Hibernation mode and turned off. If the power indicator is off but the Sleep indicator is on, the computer has entered Sleep mode. In both cases, press and release the power button to turn the computer back on. Note that the computer may enter Hibernation mode after being in Sleep mode for a period of time.

## What to take to short meetings

A fully charged battery runs the computer for about 2.5 hours. If your meeting is shorter than that, you probably do not need to take anything with you other than the computer.

## What to bring to long meetings

If your meeting lasts longer than 2.5 hours, or if your battery is not fully charged, you may want to take the AC adaptor with you to plug in your computer while in the meeting room.

If the meeting room does not have an electrical outlet, reduce the drain on the battery by putting the computer in Sleep mode. Press <Fn>+<F4> or close the display cover whenever you are not actively using the computer. To resume, open the display (if closed); then press and release the power button.

## Taking the computer home

When you are moving from your office to your home or vice versa.

## Preparing the computer

After disconnecting the computer from your desktop, follow these steps to prepare the computer for the trip home:

- Check if you have removed all media and compact discs from the drive(s). Failure to remove the media can damage the drive head.



- Pack the computer in a protective case that can prevent the computer from sliding around and cushion it if it should fall.



-----

**Caution:** Avoid packing items next to the top cover of the computer. Pressure against the top cover can damage the screen.

## What to take with you

Unless you already have some items at home, take the following items with you:

- AC adaptor and power cord
- The printed user's guide

## Special considerations

Follow these guidelines to protect your computer while traveling to and from work:

- Minimise the effects of temperature changes by keeping the computer with you.
- If you need to stop for an extended period of time and cannot carry the computer with you, leave the computer in the trunk of the car to avoid exposing the computer to excessive heat.
- Changes in temperature and humidity can cause condensation. Allow the computer to return to room temperature, and inspect the screen for condensation before turning on the computer. If the temperature change is greater than 18°F (10°C), allow the computer to come to room temperature slowly. If possible, leave the computer for 30 minutes in an environment with a temperature between outside and room temperature.

## Setting up a home office

If you frequently work on your computer at home, you may want to purchase a second AC adaptor for use at home. With a second AC adaptor, you can avoid carrying the extra weight to and from home.

If you use your computer at home for significant periods of time, you might also want to add an external keyboard, monitor, or mouse.

## Traveling with the computer

When you are moving within a larger distance, for instance, from your office building to a client's office building or traveling locally.

### Preparing the computer

Prepare the computer as if you were taking it home. Make sure that the battery in the computer is charged. Airport security may require you to turn on your computer when carrying it into the gate area.

### What to take with you

Take the following items with you:

- AC adaptor
- Spare, fully-charged battery pack(s)
- Additional printer driver files if you plan to use another printer

### Special considerations

In addition to the guidelines for taking the computer home, follow these guidelines to protect your computer while traveling:

- Always take the computer as carry-on luggage.
- If possible, have the computer inspected by hand. Airport security X-ray machines are safe, but do not put the computer through a metal detector.
- Avoid exposing floppy discs to hand-held metal detectors.

## Traveling internationally with the computer

When you are moving from country to country.

### Preparing the computer

Prepare the computer as you would normally prepare it for traveling.

### What to bring with you

Bring the following items with you:

- AC adaptor
- Power cords that are appropriate for the country to which you are traveling
- Spare, fully-charged battery packs
- Additional printer driver files if you plan to use another printer
- Proof of purchase, in case you need to show it to customs officials
- International Traveler's Warranty passport

### Special considerations

Follow the same special considerations as when traveling with the computer. In addition, these tips are useful when traveling internationally:

- When traveling in another country, check that the local AC voltage and the AC adaptor power cord specifications are compatible. If not, purchase a power cord that is compatible with the local AC voltage. Do not use converter kits sold for appliances to power the computer.
- If you are using the modem, check if the modem and connector is compatible with the telecommunications system of the country you are traveling in.

# Securing your computer

Your computer is a valuable investment that you need to take care of. Learn how to protect and take care of your computer.

Security features include hardware and software locks — a security notch and passwords.

## Using a computer security lock

A security keylock notch, located on the rear of the computer, lets you connect a Kensington-compatible computer security lock.

Wrap a computer security lock cable around an immovable object such as a table or handle of a locked drawer. Insert the lock into the notch and turn the key to secure the lock. Some keyless models are also available.

## Using passwords

Passwords protect your computer from unauthorised access. Setting these passwords creates several different levels of protection for your computer and data:

- Supervisor Password prevents unauthorised entry into the BIOS Utility. Once set, you must enter this password to gain access to the BIOS Utility. See **“BIOS Utility” on page 42.**
- User Password secures your computer against unauthorised use. Combine the use of this password with password checkpoints on boot-up and resume from hibernation for maximum security.
- Password on Boot secures your computer against unauthorised use. Combine the use of this password with password checkpoints on boot-up and resume from hibernation for maximum security.



**Important!** Do not forget your Supervisor Password! If you forget your password, please get in touch with your dealer or an authorised service center.

## Entering passwords

When a password is set, a password prompt appears in the center of the display screen.

- When the Supervisor Password is set, a prompt appears when you press <F2> to enter the BIOS Utility at boot-up.
- Type the Supervisor Password and press <Enter> to access the BIOS Utility. If you enter the password incorrectly, a warning message appears. Try again and press <Enter>.
- When the User Password is set and the password on boot parameter is enabled, a prompt appears at boot-up.
- Type the User Password and press <Enter> to use the computer. If you enter the password incorrectly, a warning message appears. Try again and press <Enter>.



.....

**Important!** You have three chances to enter a password. If you fail to enter the password correctly after three tries, the system halts. Press and hold the power button for four seconds to shut down the computer. Then turn on the computer again, and try again.

## Setting passwords

You can set passwords using the BIOS Utility.



# Expanding through options

Your Notebook PC offers you a complete mobile computing experience.

## Connectivity options

Ports allow you to connect peripheral devices to your computer as you would with a desktop PC. For instructions on how to connect different external devices to the computer, see your online guide for more details.

### Fax/Data modem

Your computer has a built-in V.92 56Kbps AC'97 Link fax/data modem.



.....

**Warning! This modem port is not compatible with digital phone lines. Plugging this modem into a digital phone line will damage the modem.**

To use the fax/data modem port, connect a phone cable from the modem port to a telephone jack.

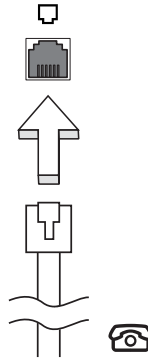

.....

**Warning: Please make sure that the cable you use is appropriate for the country in which you are working.**

## Built-in network feature

The built-in network feature allows you to connect your computer to an Ethernet-based network.

To use the network feature, connect an Ethernet cable from the network jack on the rear of the computer to a network jack or hub on your network.

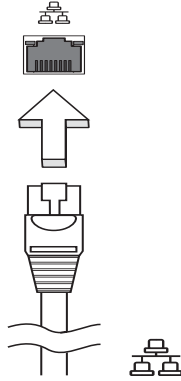

## Fast Infrared

The computer's Fast Infrared (FIR) port allows you to do wireless data transfer with other IR-aware computers and peripherals such as PDAs, mobile phones, and infrared printers. The infrared port can transfer data at speeds of up to 4 Mbps at a distance of up to one metre.

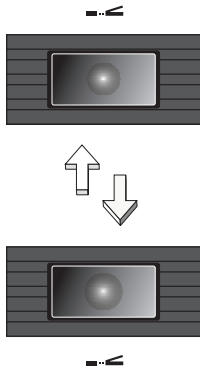



## Universal Serial Bus

The USB 2.0 port is a high-speed serial bus which allows you to connect USB peripherals without taking up precious system resources.

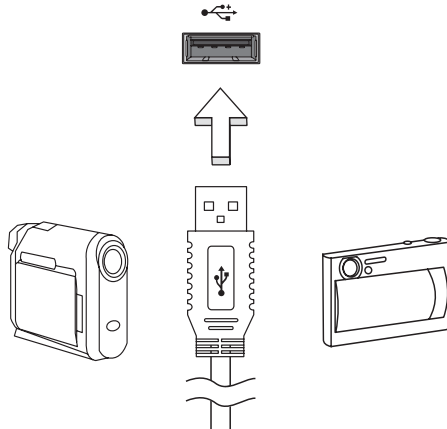

## IEEE 1394 port

The computer's IEEE 1394 port allows you to connect to an IEEE 1394-compatible device like a video camera or digital camera.

See your video or digital camera's documentation for details.

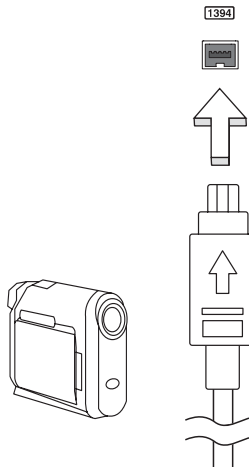

## PC Card slot

The Type II PC Card slot of the computer accepts PC Cards that enhance the usability and expandability of the computer. These cards should have a PC Card logo on them.

PC Cards (formerly PCMCIA) are add-on cards for portable computers, giving you expansion possibilities long afforded by desktop PCs. Popular PC Cards include flash, fax/data modem, LAN, wireless LAN and SCSI cards. CardBus improves on the 16-bit PC card technology by expanding the bandwidth to 32 bits.



**Note:** Refer to your card's manual for details on how to install and use the card, and its functions.

### Inserting a PC Card

Insert the card into the slot and make the proper connections (e.g., network cable), if necessary. See your card manual for details.

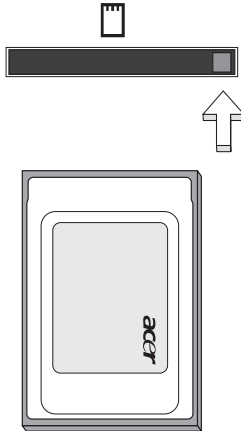

## Ejecting a PC Card

Before ejecting a PC Card:

- 1 Exit the application using the card.
- 2 Left-click on the PC Card icon on the taskbar and stop the card operation.
- 3 Press the slot eject button to pop out the eject button; then press it again to eject the card.

## Installing memory

Follow these steps to install memory:

- 1 Turn off the computer, unplug the AC adaptor (if connected) and remove the battery pack. Then turn the computer over to access its base.
- 2 Remove the screws from the memory cover; then lift up and remove the memory cover.
- 3 (a) Insert the memory module diagonally into the slot, then (b) gently press it down until it clicks into place.

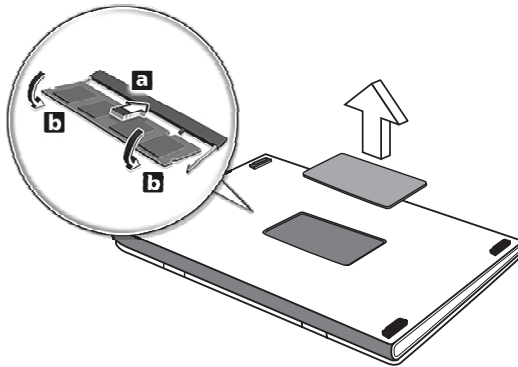

- 4 Replace the memory cover and secure it with the screw.
- 5 Reinstall the battery pack, and reconnect the AC adaptor.
- 6 Turn on the computer.

The computer automatically detects and reconfigures the total memory size. Please consult a qualified technician or contact your local Acer dealer.

## BIOS Utility

The BIOS Utility is a hardware configuration program built into your computer's BIOS.

Your computer is already properly configured and optimised, and you do not need to run this utility. However, if you encounter configuration problems, you may need to run it.

To activate the BIOS Utility, press <F2> during the POST; while the Notebook PC logo is being displayed.

## Boot sequence

To set the boot sequence in the BIOS Utility, activate the BIOS Utility, then select "Boot" from the categories listed at the top of the screen.

## Disc to Disc Recovery enable

To enable Disc to Disc Recovery (Hard Disk Recovery), activate the BIOS utility, then select "**Main**" from the categories listed at the top of the screen. Find "**D2D Recovery**" at the bottom of the screen and use the F5/F6 keys to set this value to "**Enabled**".

## Password

To set a password on boot, activate the BIOS Utility, then select "**Security**" from the categories listed at the top of the screen. Find "**Password on boot:**" and use the F5/F6 keys to "**Enable**" this feature.

## Using software

### Playing DVD movies

When the DVD drive module is installed in the optical drive bay, you can play DVD movies on your computer.

- 1 Eject the DVD tray and insert a DVD movie disc; then close the DVD tray.



**Important!** When you launch the DVD player for the first time, the programme asks you to enter the region code. DVD discs are divided into 6 regions. Once your DVD drive is set to a region code, it will play DVD discs of that region only. You can set the region code a maximum of five times (including the first time), after which the last region code set will remain permanent. Recovering your hard disc does not reset the number of times the region code has been set. Refer to the table below for DVD movie region code information.

- 2 The DVD movie will automatically play after a few seconds.

Region code	Country or region
1	U.S.A., Canada
2	Europe, Middle East, South Africa, Japan
3	Southeast Asia, Taiwan, Korea (South)
4	Latin America, Australia, New Zealand
5	Former U.S.S.R., parts of Africa, India
6	People's Republic of China



**Note:** To change the region code, insert a DVD movie of a different region into the DVD drive. Please refer to the online help for more information.

# Power management

This computer has a built-in power management unit that monitors system activity. System activity refers to any activity involving one or more of the following devices: keyboard, mouse, floppy drive, hard disc, peripherals connected to the serial and parallel ports, and video memory. If no activity is detected for a period of time (called an inactivity timeout), the computer stops some or all of these devices in order to conserve energy.

This computer employs a power management scheme that supports the advanced configuration and power interface (ACPI), which allows for maximum power conservation and maximum performance at the same time. Windows handles all power-saving chores for your computer.

# Acer eRecovery

Acer eRecovery is a tool to quickly backup and restore the system. User can create and save backup of the current system configuration to hard drive, CD, or DVD.

Acer eRecovery consists of the following functions:

- 1 Create backup
- 2 Restore from backup
- 3 Create factory default image CD
- 4 Re-install bundled software without CD
- 5 Change Acer eRecovery password

This chapter will guide you through each process.



-----  
Note: This feature is only available on certain models.



-----  
Note: For systems that do not have a built-in optical disc burner, plug in an external USB or IEEE 1394-compatible optical disc burner before entering Acer eRecovery for optical disc related tasks.

## Create backup

User can create and save backup images to hard drive, CD, or DVD.

- 1 Boot to Windows XP
- 2 Press <Alt>+<F10> to open the Acer eRecovery utility.
- 3 Enter the password to proceed. The default password is six zeros.
- 4 In the Acer eRecovery window, select **Recovery settings** and click **Next**.
- 5 In the Recovery settings window, select **Backup snapshot image** and click **Next**.
- 6 Select the backup method.

- a Use **Backup to HDD** to store the backup disc image on drive D:.
- b **Backup to optical device** to store the backup disc image on CD or DVD.

7 After choosing the backup method, click **Next**.

Follow the instruction on screen to complete the process.

## Restore from backup

User can restore backup previously created (as stated in the **Create backup** section) from hard drive, CD, or DVD.

- 1 Boot to Windows XP.
- 2 Press <Alt>+<F10> to open the Acer eRecovery utility.
- 3 Enter the password to proceed. The default password is six zeros.
- 4 In the Acer eRecovery window, select **Recovery actions** and click **Next**.
- 5 Select the desired restore action and follow the onscreen instructions to complete the restore process.



.....

Note: The "Restore C:" item is enabled only if there is a user backup stored on the hard drive (D:\). Please refer to the **Create backup** section.

## Create factory default image CD

When the System CD and Recovery CD are not available, you can create them by using this feature.

- 1 Boot to Windows XP.
- 2 Press <Alt>+<F10> to open the Acer eRecovery utility.
- 3 Enter the password to proceed. The default password is six zeros.
- 4 In the Acer eRecovery window, select **Recovery settings** and click **Next**.
- 5 In the Recovery settings window, select **Burn image to disc** and click **Next**.
- 6 In the Burn image to disc window, select **01. Factory default image** and click **Next**.



- 7 Follow the instructions on screen to complete the process.

## Re-install bundled software without CD

Acer eRecovery stores pre-loaded software internally for easy driver and application re-installation.

- 1 Boot to Windows XP.
- 2 Press <Alt>+<F10> to open the Acer eRecovery utility.
- 3 Enter the password to proceed. The default password is six zeros.
- 4 In the Acer eRecovery window, select **Recovery actions** and click **Next**.
- 5 In the Recovery settings window, select **Reinstall applications/drivers** and click **Next**.
- 6 Select the desired driver/application and follow the instructions on screen to re-install.

At first launch, Acer eRecovery prepares all the needed software and may take few seconds to bring up the software content window.

## Change password

Acer eRecovery and Acer disc-to-disc recovery are protected by a password that can be changed by the user. Follow the steps below to change the password in Acer eRecovery.

- 1 Boot to Windows XP.
- 2 Press <Alt>+<F10> to open the Acer eRecovery utility.
- 3 Enter the password to proceed. The default password is six zeros.
- 4 In the Acer eRecovery window, select **Recovery settings** and click **Next**.
- 5 In the Recovery settings window, select **Password: Change Acer eRecovery password** and click **Next**.
- 6 Follow the instructions on screen to complete the process.



.....  
Note: If the system crashes, and will not boot to Windows, you can run Acer disc-to-disc recovery to restore the factory default image under DOS mode.

# Acer disc-to-disc recovery



.....  
**Note:** This feature is only available on certain models.

## Multilingual operating system installation

Follow the instructions to choose the operating system and language you use when you first power-on the system.

- 1 Turn on the system.
- 2 Acer's multilingual operating system selection menu will pop-up automatically.
- 3 Use the arrow keys to scroll to the language version you want. Press <Enter> to confirm your selection.
- 4 The operating system and language you choose now will be the only option for future recovery operations.
- 5 The system will install the operating system and language you choose.

## Restore without a Recovery CD

This recovery process helps you restore the C: drive with the original software content that is installed when you purchase your notebook. Follow the steps below to rebuild your C: drive. (Your C: drive will be reformatted and all data will be erased.) It is important to back up all data files before you use this option.

Before performing a restore operation, please check the BIOS settings.

- a** Check to see if **Acer disc-to-disc recovery** is enabled or not.
- b** Make sure the **[D2D Recovery]** setting in **[Main]** is **[Enabled]**.
- c** Exit the BIOS Setup Utility and save changes. The system will reboot.



.....  
**Note:** To activate BIOS Setup Utility, press <F2> during POST.

- 1 Restart the system.
- 2 While the Acer logo is showing, press <Alt>+<F10> at the same time to enter the recovery process.
- 3 The message "The system has password protection. Please enter 000000:" is displayed.
- 4 Enter six zeros and continue.
- 5 The Acer Recovery main page appears.
- 6 Use the arrow keys to scroll through the items and press <Enter> to select the desired choice.



.....  
**Important:** This feature occupies 2~3 GB in a hidden partition on your hard drive.



# Troubleshooting my computer

This chapter shows you how to deal with common system problems. Read it before calling a technician if a problem occurs. Solutions to more serious problems require opening up the computer. Do not attempt to open the computer by yourself. Contact your dealer or an authorised service center for assistance.

Key link: <http://global.acer.com/>

# Frequently-asked questions

The following is a list of possible situations that may arise during the use of your computer. Easy answers and solutions are provided for each one.

I pressed the power button and opened the display, but the computer does not start or boot-up.

Look at the power indicator:

- If it is not lit, no power is being supplied to the computer. Check the following:
  - If you are running on battery power, it may be low and unable to power the computer. Connect the AC adaptor to recharge the battery pack.
  - Make sure that the AC adaptor is properly plugged into the computer and to the power outlet.
- If it is lit, check the following:
  - Is a non-bootable (non-system) disc in the external USB floppy drive? Remove or replace it with a system disc and press **<Ctrl>+<Alt>+<Del>** to restart the system.

Nothing appears on the screen.

The computer's power management system automatically blanks the screen to save power. Press any key to turn the display back on.

If pressing a key does not turn the display back on, three things might be the cause:

- The brightness level might be too low. Press **<Fn>+<→>** (increase) to adjust the brightness level.
- The display device might be set to an external monitor. Press the display toggle hot key **<Fn>+<F5>** to toggle the display back to the computer.
- If the Sleep indicator is lit, the computer is in Sleep mode. Press and release the power button to resume.

Image is not full-screen.

The computer display has a native resolution of 1024 x 768 (XGA) for the 14.1"/15.0" screens. If you set the resolution lower than this, the screen expands to fill the computer display. Right-click on your Windows desktop and select Properties to bring up the **Display Properties** dialog box. Then click on the Settings tab to make sure that the resolution is set to the appropriate resolution. Resolutions lower than the specified resolution are not full-screen on the computer or on an external monitor.

No audio is heard from the computer.

Check the following:

- The volume may be muted. In Windows, look at the volume control (speaker) icon on the taskbar. If it is crossed-out, click on the icon and deselect the Mute option.
- The volume level may be too low. In Windows, look at the volume control icon on the taskbar. You can also use the volume control buttons to adjust the volume. See **"Hot keys" on page 17** for more detail.
- If headphones, earphones or external speakers are connected to the line-out port on the computer's left panel, the internal speakers automatically turn off.

I want to eject the optical drive tray without turning on the power. I cannot eject the optical drive tray.

There is a mechanical eject button on the optical drive. Simply insert the tip of a pen or paperclip and push to eject the tray.

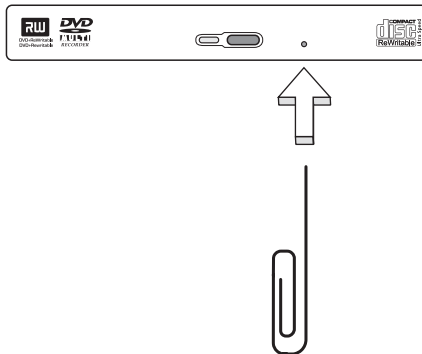



The keyboard does not respond.

Try attaching an external keyboard to a USB 2.0 port on the rear or left of the computer. If it works, contact your dealer or an authorised service center as the internal keyboard cable may be loose.

The infrared port does not work.

Check the following:

- Make sure that the infrared ports of the two devices are facing each other (+/- 15 degrees) a maximum of 1 metre apart.
- Make sure there is a clear path between the two infrared ports. Nothing should be blocking the ports.
- Make sure you have the appropriate software running on both devices (for file transfers) or you have the appropriate drivers (for printing to an infrared printer).
- During the POST, press <F2> to access the BIOS Utility and verify that the infrared port is enabled.
- Make sure both devices are IrDA-compliant.

The printer does not work.

Check the following:

- Make sure that the printer is connected to a power outlet and that it is turned on.
- Make sure that the printer cable is connected securely to the computer's parallel port and the corresponding port on the printer.
- During POST, press <F2> to access the BIOS Utility and verify that the parallel port is enabled.

I want to set up my location to use the internal modem.

To properly use your communication software (e.g. HyperTerminal), you need to set up your location:

- 1 Click on **Start, Settings, Control Panel**.
- 2 Double-click on **Modems**.
- 3 Click on **Dialing Properties** and begin setting up your location.

Refer to the Windows manual.



Please note, on first booting your notebook, that you can skip the Internet Connection setup, as it is not necessary to affect the installation of your overall Operating System. After the Operating System is setup, you can proceed with the Internet Connection setup.

## Troubleshooting tips

This notebook computer incorporates an advanced design that delivers onscreen error message reports to help you solve problems.

If the system reports an error message or an error symptom occurs, see **“Error messages” on page 56**. If the problem cannot be resolved, contact your dealer. See **“Requesting service” on page 57**.

## Error messages

If you receive an error message, note the message and take the corrective action. The following table lists the error messages in alphabetical order together with the recommended course of action.

Error Messages	Corrective Action
CMOS Battery Bad	Contact your dealer or an authorised service center.
CMOS Checksum Error	Contact your dealer or an authorised service center.
Disc Boot Failure	Insert a system (bootable) disc into the floppy drive (A:), then press <Enter> to reboot.
Equipment Configuration Error	Press <F2> (during POST) to enter the BIOS Utility; then press <b>Exit</b> in the BIOS Utility to reboot.
Hard Disc 0 Error	Contact your dealer or an authorised service center.
Hard Disc 0 Extended Type Error	Contact your dealer or an authorised service center.

Error Messages	Corrective Action
I/O Parity Error	Contact your dealer or an authorised service center.
Keyboard Error or No Keyboard Connected	Contact your dealer or an authorised service center.
Keyboard Interface Error	Contact your dealer or an authorised service center.
Memory Size Mismatch	Press <F2> (during POST) to enter the BIOS Utility; then press <b>Exit</b> in the BIOS Utility to reboot.

If you still encounter problems after going through the corrective measures, please contact your dealer or an authorised service center for assistance. Some problems may be solved using the BIOS Utility.

## Requesting service

### International Traveler's Warranty (ITW)

Your computer is backed by an International Traveler's Warranty (ITW) that gives you security and peace of mind when traveling. Our worldwide network of service centers are there to give you a helping hand.

An ITW passport comes with your computer. This passport contains all you need to know about the ITW program. A list of available, authorised service centers is in this handy booklet. Read this passport thoroughly.

Always have your ITW passport on hand, especially when you travel, to receive the benefits from our support centers. Place your proof-of-purchase in the flap located inside the front cover of the ITW passport.

If the country you are traveling in does not have an Acer-authorised ITW service site, you can still get in contact with our offices worldwide.

Please consult <http://global.acer.com>.

## Before you call

Please have the following information available when you call Acer for online service, and please be at your computer when you call. With your support, we can reduce the amount of time a call takes and help solve your problems efficiently.

If there are error messages or beeps reported by your computer, write them down as they appear on the screen (or the number and sequence in the case of beeps).

You are required to provide the following information:

Name: \_\_\_\_\_

Address: \_\_\_\_\_

\_\_\_\_\_

Telephone number: \_\_\_\_\_

Machine and model type: \_\_\_\_\_

Serial number: \_\_\_\_\_

Date of purchase: \_\_\_\_\_

Appendix A

# Regulation & safety notices

This appendix lists the general notices for your computer.

## Energy Star Guidelines Compliance

As an Energy Star partner, Acer Inc. has determined that this product meets the Energy Star guidelines for energy efficiency.

### FCC notice

This device has been tested and found to comply with the limits for a Class B digital device pursuant to Part 15 of the FCC rules. These limits are designed to provide reasonable protection against harmful interference in a residential installation. This device generates, uses, and can radiate radio frequency energy and, if not installed and used in accordance with the instructions, may cause harmful interference to radio communications.

However, there is no guarantee that interference will not occur in a particular installation. If this device does cause harmful interference to radio or television reception, which can be determined by turning the device off and on, the user is encouraged to try to correct the interference by one or more of the following measures:

- Reorient or relocate the receiving antenna.
- Increase the separation between the device and receiver.
- Connect the device into an outlet on a circuit different from that to which the receiver is connected.
- Consult the dealer or an experienced radio/television technician for help.

### Notice: Shielded cables

All connections to other computing devices must be made using shielded cables to maintain compliance with FCC regulations.

### Notice: Peripheral devices

Only peripherals (input/output devices, terminals, printers, etc.) certified to comply with the Class B limits may be attached to this equipment. Operation with non-certified peripherals is likely to result in interference to radio and TV reception.

## Caution

Changes or modifications not expressly approved by the manufacturer could void the user's authority, which is granted by the Federal Communications Commission, to operate this computer.

## Operation conditions

This device complies with Part 15 of the FCC Rules. Operation is subject to the following two conditions: (1) this device may not cause harmful interference, and (2) this device must accept any interference received, including interference that may cause undesired operation.

## Notice: Canadian users

This Class B digital apparatus complies with Canadian ICES-003.

## Remarque à l'intention des utilisateurs canadiens

Cet appareil numérique de la classe B est conforme à la norme NMB-003 du Canada.

## Declaration of Conformity for EU countries

Hereby, Acer, declares that this Notebook PC series is in compliance with the essential requirements and other relevant provisions of Directive 1999/5/EC. (Please visit <http://global.acer.com/products/notebook/reg-nb/index.htm> for complete documents.)

## Modem notices

### Notice for USA

This equipment complies with Part 68 of the FCC rules. Located on the modem is a label that contains, among other information, the FCC Registration Number and Ringer Equivalence Number (REN) for this equipment. Upon request, you must provide this information to your telephone company.

If your telephone equipment causes harm to the telephone network, the telephone company may discontinue your service temporarily. If possible, they will notify you in advance. But, if advance notice is not practical, you will be notified as soon as possible. You will also be informed of your right to file a complaint with the FCC.



Your telephone company may make changes in its facilities, equipment, operations, or procedures that could affect the proper functioning of your equipment. If they do, you will be notified in advance to give you an opportunity to maintain uninterrupted telephone service.

If this equipment should fail to operate properly, disconnect the equipment from the phone line to determine if it is causing the problem. If the problem is with the equipment, discontinue use and contact your dealer or vendor.



**Caution:** To reduce the risk of fire, use only No. 26 AWG or larger UL Listed or CSA Certified Telecommunication Line Cord.

## TBR 21

This equipment has been approved [Council Decision 98/482/EC - "TBR 21"] for single terminal connection to the Public Switched Telephone Network (PSTN). However, due to differences between the individual PSTNs provided in different countries, the approval does not, of itself, give an unconditional assurance of successful operation on every PSTN termination point. In the event of problems, you should contact your equipment supplier in the first instance.

## List of Applicable Countries

EU member states as of May 2004 are: Belgium, Denmark, Germany, Greece, Spain, France, Ireland, Italy, Luxembourg, the Netherlands, Austria, Portugal, Finland, Sweden, United Kingdom, Estonia, Latvia, Lithuania, Poland, Hungary, Czech Republic, Slovak Republic, Slovenia, Cyprus and Malta. Usage allowed in the countries of European Union, as well as Norway, Switzerland, Iceland and Liechtenstein. This device must be used in strict accordance with the regulations and constraints in the country of use. For further information, please contact local office in the country of use.

## Notice for Australia

For safety reasons, only connect headsets with a telecommunications compliance label. This includes customer equipment previously labelled permitted or certified.

## Notice for New Zealand

### For modem with approval number PTC 211/03/008

- 1 The grant of a Telepermit for any item of terminal equipment indicates only that Telecom has accepted that the item complies with minimum conditions for connection to its network. It indicates no endorsement of the product by Telecom, nor does it provide any sort of warranty. Above all, it provides no assurance that any item will work correctly in all respects with another item of Telepermitted equipment of a different make or model, nor does it imply that any product is compatible with all of Telecom's network services.
- 2 This equipment is not capable, under all operating conditions, of correct operation at the higher speeds for which it is designed. Telecom will accept no responsibility should difficulties arise in such circumstances.
- 3 Some parameters required for compliance with Telecom's Telepermit requirements are dependent on the equipment (PC) associated with this device. The associated equipment shall be set to operate within the following limits for compliance with Telecom's Specifications:
  - a There shall be no more than 10 call attempts to the same number within any 30 minute period for any single manual call initiation, and
  - b The equipment shall go on-hook for a period of not less than 30 seconds between the end of one attempt and the beginning of the next call attempt.
- 4 Some parameters required for compliance with Telecom's Telepermit requirements are dependent on the equipment (PC) associated with this device. In order to operate within the limits for compliance with Telecom's specifications, the associated equipment shall be set to ensure that automatic calls to different numbers are spaced such that there is not less than 5 seconds between the end of one call attempt and the beginning of another.
- 5 This equipment shall not be set up to make automatic calls to Telecom's 111 Emergency Service.

### For modem with approval number PTC 211/01/030

- 1 The grant of a Telepermit for any item of terminal equipment indicates only that Telecom has accepted that the item complies with minimum conditions for connection to its network. It

indicates no endorsement of the product by Telecom, nor does it provide any sort of warranty. Above all, it provides no assurance that any item will work correctly in all respects with another item of Telepermitted equipment of a different make or model, nor does it imply that any product is compatible with all of Telecom's network services.

- 2 This equipment is not capable, under all operating conditions, of correct operation at the higher speeds for which it is designed. Telecom will accept no responsibility should difficulties arise in such circumstances.
- 3 This device is equipped with pulse dialing while the Telecom standard is DTMF tone dialing. There is no guarantee that Telecom lines will always continue to support pulse dialing.
- 4 Use of pulse dialing, when this equipment is connected to the same line as other equipment, may give rise to bell tinkle or noise and may also cause a false answer condition. Should such problems occur, the user should NOT contact the telecom Fault Service.
- 5 This equipment may not provide for the effective hand-over of a call to another device connected to the same line.
- 6 Under power failure conditions this appliance may not operate. Please ensure that a separate telephone, not dependent on local power, is available for emergency use.
- 7 Some parameters required for compliance with Telecom's Telepermit requirements are dependent on the equipment (PC) associated with this device. The associated equipment shall be set to operate within the following limits for compliance with Telecom's specifications, the associated equipment shall be set to ensure that calls are answered between 3 and 30 seconds of receipt of ringing.
- 8 This equipment shall not be set up to make automatic calls to Telecom's 111 Emergency Service.

## Important safety instructions

Read these instructions carefully. Save them for future reference.

- 1 Follow all warnings and instructions marked on the product.
- 2 Unplug this product from the wall outlet before cleaning. Do not use liquid cleaners or aerosol cleaners. Use a damp cloth for cleaning.
- 3 Do not use this product near water.

- 4 Do not place this product on an unstable cart, stand, or table. The product may fall, causing serious damage to the product.
- 5 Slots and openings are provided for ventilation; to ensure reliable operation of the product and to protect it from overheating. These openings must not be blocked or covered. The openings should never be blocked by placing the product on a bed, sofa, rug, or other similar surface. This product should never be placed near or over a radiator or heat register, or in a built-in installation unless proper ventilation is provided.
- 6 This product should be operated from the type of power indicated on the marking label. If you are not sure of the type of power available, consult your dealer or local power company.
- 7 Do not allow anything to rest on the power cord. Do not locate this product where persons will walk on the cord.
- 8 If an extension cord is used with this product, make sure that the total ampere rating of the equipment plugged into the extension cord does not exceed the extension cord ampere rating. Also, make sure that the total rating of all products plugged into the wall outlet does not exceed the fuse rating.
- 9 Never push objects of any kind into this product through cabinet slots as they may touch dangerous voltage points or short out parts that could result in a fire or electric shock. Never spill liquid of any kind on the product.
- 10 Do not attempt to service this product yourself, as opening or removing covers may expose you to dangerous voltage points or other risks. Refer all servicing to qualified service personnel.
- 11 Unplug this product from the wall outlet and refer servicing to qualified service personnel under the following conditions:
  - a When the power cord or plug is damaged or frayed.
  - b If liquid has been spilled into the product.
  - c If the product has been exposed to rain or water.
  - d If the product does not operate normally when the operating instructions are followed. Adjust only those controls that are covered by the operating instructions since improper adjustment of other controls may result in damage and will often require extensive work by a qualified technician to restore the product to normal condition.
  - e If the product has been dropped or the case has been damaged.

- f If the product exhibits a distinct change in performance, indicating a need for service.
- 12 The Notebook PC series uses lithium batteries. Replace the battery with the same type as the product's battery we recommend in the product specification list. Use of another battery may present a risk of fire or explosion.
- 13 **Warning!** Batteries may explode if not handled properly. Do not disassemble or dispose of them in fire. Keep them away from children and dispose of used batteries promptly.
- 14 To avoid hazard of unexpected electrical shock, use the AC adaptor only when the wall socket is properly grounded.
- 15 Use only the proper type of power supply cord set (provided in your accessories box) for this unit. It should be a detachable type: UL listed/CSA certified, type SPT-2, rated 7 A 125 V minimum, VDE approved or its equivalent. Maximum length is 15 feet (4.6 metres).
- 16 Always disconnect all telephone lines from the wall outlet before serving or disassembling this equipment.
- 17 Avoid using a telephone (other than a cordless type) during an electrical storm. There may be a remote risk of electric shock from lightning.

## Laser compliance statement

The CD or DVD drive used with this computer is a laser product. The CD or DVD drive's classification label (shown below) is located on the drive.

**CLASS 1 LASER PRODUCT**

**CAUTION: INVISIBLE LASER RADIATION WHEN OPEN. AVOID EXPOSURE TO BEAM.**

**APPAREIL A LASER DE CLASSE 1 PRODUIT**

**LASERATTENTION: RADIATION DU FAISCEAU LASER INVISIBLE EN CAS D'OUVERTURE. EVITER TOUTE EXPOSITION AUX RAYONS.**

**LUOKAN 1 LASERLAITE LASER KLASSE 1**

**VORSICHT: UNSICHTBARE LASERSTRAHLUNG, WENN ABDECKUNG GEÖFFNET NICHT DEM STRAHL AUSSETZEN**

**PRODUCTO LÁSER DE LA CLASE I**

**ADVERTENCIA: RADIACIÓN LÁSER INVISIBLE AL SER ABIERTO. EVITE EXPONERSE A LOS RAYOS.**

ADVARSEL: LASERSTRÅLING VEDÅBNING SE IKKE IND I STRÅLEN.

VARO! LAVATTAESSA OLET ALTTINA LASERSÄTEILYLLE.

VARNING: LASERSTRÅLNING NÅR DENNA DEL ÅR ÖPPNAD ÅLÅ  
TUIJOTA SÄTEESEENSTIRRA EJ IN I STRÅLEN

VARNING: LASERSTRÅLNING NAR DENNA DEL ÅR ÖPPNADSTIRRA EJ IN  
I STRÅLEN

ADVARSEL: LASERSTRÅLING NAR DEKSEL ÅPNESSTIRR IKKE INN I  
STRÅLEN

## LCD pixel statement

The LCD unit is produced with high-precision manufacturing techniques. Nevertheless, some pixels may occasionally misfire or appear as black or red dots. This has no effect on the recorded image and does not constitute a malfunction.

## Macrovision® copyright protection notice

This product incorporates copyright protection technology that is protected by method claims of certain U.S. patents and other intellectual property rights owned by Macrovision Corporation and other rights owners. Use of this copyright protection technology must be authorised by Macrovision Corporation, and is intended for home and other limited viewing uses only unless otherwise authorised by Macrovision Corporation. Reverse engineering or disassembly is prohibited.

Apparatus Claims of U.S. Patent Nos. 4,631,603, 4,577,216, 4,819,098, 4,907,093, and 6,516,132 licensed for limited viewing uses only.

## Radio Device Regulatory Notice

**Note:** Below regulatory information is for models with wireless LAN and/or Bluetooth® only.

## General

This product complies with the radio frequency and safety standards of any country or region in which it has been approved for wireless use. Depending on configurations, this product may or may not contain wireless radio devices (such as wireless LAN and/or Bluetooth® modules). Below information is for products with such devices.

## European Union (EU)

This device complies with the essential requirements of the European Council Directives listed below:

### 73/23/EEC Low Voltage Directive

- EN 60950

### 89/336/EEC Electromagnetic Compatibility (EMC) Directive

- EN 55022
- EN 55024
- EN 61000-3-2/-3

### 99/5/EC Radio & Telecommunications Terminal Equipment (R&TTE) Directive

- Art.3.1a) EN 60950
- Art.3.1b) EN 301 489 -1/-17
- Art.3.2) EN 300 328-2
- Art.3.2) EN 301 893 \*applies to 5 GHz only

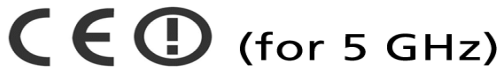

## List of Applicable Countries

EU member states as of May 2004 are: Belgium, Denmark, Germany, Greece, Spain, France, Ireland, Italy, Luxembourg, the Netherlands, Austria, Portugal, Finland, Sweden, United Kingdom, Estonia, Latvia, Lithuania, Poland, Hungary, Czech Republic, Slovak Republic, Slovenia, Cyprus and Malta. Usage allowed in the countries of European Union, as well as Norway, Switzerland, Iceland and Liechtenstein. This device must be used in strict accordance with the regulations and constraints in the country of use. For further information, please contact local office in the country of use.

## The FCC RF safety requirement

The radiated output power of Wireless LAN Mini-PCI Card and Bluetooth® card is far below the FCC radio frequency exposure limits. Nevertheless, the Notebook PC series shall be used in such a manner that the potential for human contact during normal operation is minimized as follows:

- 1 Users are requested to follow the RF safety instructions on wireless option devices that are included in the user's manual of each RF option device.



**Caution:** To comply with FCC RF exposure compliance requirements, a separation distance of at least 20 cm (8 inches) must be maintained between the antenna for the integrated Wireless LAN Mini-PCI Card built in to the screen section and all persons.

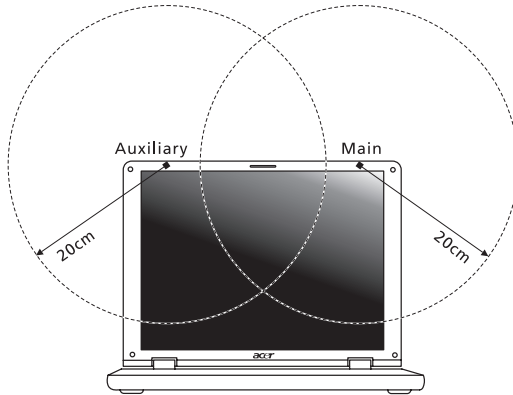

**Note:** Acer Wireless Mini PCI Adapter implements a transmission diversity function. The function does not emit radio frequencies simultaneously from both antennas. One of the antennas is selected automatically or manually (by users) to ensure good-quality radiocommunication.

- 2 This device is restricted to indoor use due to its operation in the 5.15 to 5.25 GHz frequency range. FCC requires this product to be used indoors for the frequency range 5.15 to 5.25 GHz to reduce the potential for harmful interference to co-channel Mobile Satellite systems.
- 3 High power radar are allocated as primary users of the 5.25 to 5.35 GHz and 5.65 to 5.85 GHz bands. These radar stations can cause interference with and/or damage this device.
- 4 An improper installation or unauthorised use may cause harmful interference to radio communications. Also any tampering of the internal antenna will void the FCC certification and your warranty.



## Canada - Low power license-exempt radio communication devices (RSS-210)

- a Common information
  - Operation is subject to the following two conditions:
    1. This device may not cause interference, and
    2. this device must accept any interference, including interference that may cause undesired operation of the device.
- b Operation in 2.4 GHz band
  - To prevent radio interference to the licensed service, this device is intended to be operated indoors and installation outdoors is subject to licensing.
- c Operation in 5 GHz band
  - The device for the band 5150-5250 MHz is only for indoor usage to reduce potential for harmful interference to co-channel Mobile Satellite systems.
  - High power radars are allocated as primary users (meaning they have priority) of 5250-5350 MHz and 5650-5850 MHz and these radars could cause interference and/or damage to LELAN (Licence-Exempt Local Area Network) devices.

## Exposure of humans to RF fields (RSS-102)

The Notebook PC series employs low gain integral antennas that do not emit RF field in excess of Health Canada limits for the general population; consult Safety Code 6, obtainable from Health Canada's Web site at [www.hc-sc.gc.ca/rpb](http://www.hc-sc.gc.ca/rpb).

**Federal Communications Commission  
Declaration of Conformity**

This device complies with Part 15 of the FCC Rules. Operation is subject to the following two conditions: (1) this device may not cause harmful interference, and (2) this device must accept any interference received, including interference that may cause undesired operation.

The following local Manufacturer/Importer is responsible for this declaration:

Product:	Notebook Personal Computer
Model Number:	ZL2
Machine Type:	Extensa 4100
SKU Number:	Extensa 41xx (*x* = 0~9, a ~ z, or A ~ Z)
Name of Responsible Party:	Acer America Corporation
Address of Responsible Party:	2641 Orchard Parkway, San Jose CA 95134, U. S. A.
Contact Person:	Mr. Young Kim
Phone No.:	408-922-2909
Fax No.:	408-922-2606



**Acer Incorporated**  
8F, 88, Sec. 1, Hsin Tai Wu Rd., Hsichih  
Taipei Hsien 221, Taiwan

Tel : 886-2-2696-1234  
Fax : 886-2-2696-3535  
www.acer.com



### Declaration of Conformity for CE marking

We,

Acer Inc.  
8F, 88, Sec. 1, Hsin Tai Wu Rd., Hsichih,  
Taipei Hsien 221, Taiwan

Contact Person: Mr. Easy Lai  
Tel: 886-2-8691-3089 Fax: 886-2-8691-3000  
E-mail: [easy\\_lai@acer.com.tw](mailto:easy_lai@acer.com.tw)

Hereby declare that:

Product:	Notebook PC
Trade Name:	Acer
Model Number:	ZL2
Machine Type:	Extensa 4100
SKU Number:	Extensa 41xx (*x* = 0~9, a~z, or A~Z)

Is in compliance with the essential requirements and other relevant provisions of the following EC directives.

Reference No.	Title
89/336/EEC	Electromagnetic Compatibility (EMC directive)
73/23/EEC	Low Voltage Directive (LVD)
1999/5/EC	Radio & Telecommunications Terminal Equipment Directive (R&TTE)

The product specified above was tested conforming to the applicable Rules under the most accurate measurement standards possible, and that all the necessary steps have been taken and are in force to assure that production units of the same product will continue to comply with the requirements.

*Easy Lai*

-----  
Easy Lai/ Director  
Qualification Center  
Product Assurance, Acer Inc.

2005/2/1

-----  
Date



**A**

- AC adapter
  - caring for v
- audio 25
  - adjusting the volume 25
  - troubleshooting 54

**B**

- battery pack
  - caring for v
- BIOS utility 42
- brightness
  - hotkeys 18

**C**

- caps lock 14
  - on indicator 12
- care
  - AC adapter v
  - battery pack v
  - computer iv
- CD-ROM
  - ejecting 23
  - ejecting manually 54
  - troubleshooting 54
- cleaning
  - computer v
- computer
  - bringing to meetings 30
  - caring for iv
  - cleaning v
  - disconnecting 29
  - features 1, 9, 28
  - indicators 12
  - keyboards 14
  - moving around 29
  - on indicator 4, 13
  - security 34
  - setting up a home office 32
  - taking home 30
  - traveling internationally 33
  - traveling on local trips 32
  - troubleshooting 52
  - turning off iv
- connections
  - network 38

**D**

- display

- hotkeys 18
- troubleshooting 53, 54
- DVD 43
- DVD movies
  - playing 43

**E**

- error messages 56
- Euro 19

**F**

- FAQ. See frequently-asked questions
- frequently-asked questions 53
- front view 3

**H**

- Hibernation mode
  - hotkey 17
- hotkeys 17

**I**

- IEEE 1394 port 39
- indicator lights 12
- infrared 38
- ITW. See warranty

**K**

- keyboard 14
  - embedded numeric keypad 15
  - hotkeys 17
  - lock keys 14
  - troubleshooting 55
  - Windows keys 16

**L**

- LEDs 12
- left view 3

**M**

- media access
  - on indicator 12
- memory
  - installing 41
- messages
  - error 56
- modem 37

**N**

- network 38
- Notebook Manager

- hotkey 17
- notice
  - DVD copyright protection 68
- num lock 14
  - on indicator 12
- numeric keypad
  - embedded 15
  - num lock 15

**P**

- password 34
  - types 34
- PC Card 40
  - ejecting 41
  - inserting 40
- ports 37
- printer
  - troubleshooting 55
- problems 53
  - CD-ROM 54
  - display 53, 54
  - keyboard 55
  - printer 55
  - startup 53
  - troubleshooting 52

**Q**

- questions
  - setting location for modem use 55

**S**

- safety
  - CD or DVD 67
  - FCC notice 61
  - general instructions 65
  - modem notices 62
- scroll lock 14

- security
  - keylock 24, 34
  - passwords 34
- speakers
  - hotkey 18
  - troubleshooting 54
- status indicators 12
- support
  - information 57

**T**

- touchpad 21
  - hotkey 18
  - using 21– 22
- travel
  - international flights 33
  - local trips 32
- troubleshooting 52
  - tips 56

**U**

- universal serial bus 39

**V**

- view
  - front 5
  - left 5
  - rear 7
  - right 6
- volume
  - adjusting 25

**W**

- warranty
  - International Traveler's Warranty 57
- Windows keys 16