

TravelMate 2000/2500 Series

User's Guide

Copyright © 2004. Acer Incorporated.
All Rights Reserved.

TravelMate 2000/2500 Series User's Guide
Original Issue: March 2004

Changes may be made periodically to the information in this publication without obligation to notify any person of such revision or changes. Such changes will be incorporated in new editions of this manual or supplementary documents and publications. This company makes no representations or warranties, either expressed or implied, with respect to the contents hereof and specifically disclaims the implied warranties of merchantability or fitness for a particular purpose.

Record the model number, serial number, purchase date, and place of purchase information in the space provided below. The serial number and model number are recorded on the label affixed to your computer. All correspondence concerning your unit should include the serial number, model number, and purchase information.

No part of this publication may be reproduced, stored in a retrieval system, or transmitted, in any form or by any means, electronic, mechanical, photocopy, recording, or otherwise, without the prior written permission of Acer Incorporated.

TravelMate 2000/2500 Series Notebook Computer

Model Number : _____

Serial Number: _____

Purchase Date: _____

Place of Purchase: _____

Acer and the Acer logo are registered trademarks of Acer Incorporated. Other company's product names or trademarks are used herein for identification purposes only and belong to their respective companies.

First things first

We would like to thank you for making the TravelMate series of notebook computers your choice for your mobile computing needs. We hope you will be happy with your TravelMate as much as we enjoyed making it for you.

Your guides

To help you use your TravelMate, we have designed a set of guides:



First off, the **Just for starters...** poster helps you get started with setting up your computer.



This **User's guide** introduces you to the many ways your computer can help you be more productive. This guide provides clear and concise information about the computer, so read it thoroughly.

If you ever need to print out a copy, this User's guide is also available in Portable Document Format (PDF). Follow these steps:

- 1 Click on **Start, All Programs, AcerSystem**.
- 2 Click on **AcerSystem User's guide**.

Note: Viewing the file requires Adobe Acrobat Reader installed. If Adobe Acrobat Reader is not installed on your computer, clicking on TravelMate User's guide will run the Acrobat Reader setup program first. Follow the instructions on the screen to complete the installation. For instructions on how to use Adobe Acrobat Reader, access the **Help and Support** menu.

Basic care and tips for using your computer

Turning your computer on and off

To turn on the computer, simply press and release the power switch below the LCD screen beside the Launch keys. See “Front view” on page 3 for the location of the power switch.

To turn the power off, do any of the following:

- Use the Windows shutdown command

Click on **Start, Turn Off Computer**; then click on **Turn Off**.

- Use the power switch



.....
Note: You can also use the power switch to perform power management functions. See “Power management” on page 24.

- Use the customized functions for power management

You can also shut down the computer by closing the display cover, or by pressing the sleep hot key (**Fn-F4**). See “Power management” on page 24.



.....
Note: If you cannot power off the computer normally, press and hold the power switch for more than four seconds to shut down the computer. If you turn off the computer and want to turn it on again, wait at least two seconds before powering up.

Taking care of your computer

Your computer will serve you well if you take care of it.

- Do not expose the computer to direct sunlight. Do not place it near sources of heat, such as a radiator.
- Do not expose the computer to temperatures below 0°C (32°F) or above 50°C (122°F).
- Do not subject the computer to magnetic fields.
- Do not expose the computer to rain or moisture.
- Do not spill water or any liquid on the computer.
- Do not subject the computer to heavy shock and vibration.
- Do not expose the computer to dust and dirt.

- Never place objects on top of the computer to avoid damaging the computer.
- Do not slam the computer display when you close it.
- Never place the computer on uneven surfaces.

Taking care of your AC adapter

Here are some ways to take care of your AC adapter:

- Do not connect the adapter to any other device.
- Do not step on the power cord or place heavy objects on top of it. Carefully route the power cord and any cables away from personal traffic.
- When unplugging the power cord, do not pull on the cord itself but pull on the plug.
- The total ampere ratings of the equipment plugged in should not exceed the ampere rating of the cord if you are using an extension cord. Also, the total current rating of all equipment plugged into a single wall outlet should not exceed the fuse rating.

Taking care of your battery pack

Here are some ways to take care of your battery pack:

- Use only batteries of the same kind as replacements. Turn the power off before removing or replacing batteries.
- Do not tamper with batteries. Keep them away from children.
- Dispose of used batteries according to local regulations. Recycle if at all possible.

Cleaning and servicing

When cleaning the computer, follow these steps:

- 1** Power off the computer and remove the battery pack.
- 2** Disconnect the AC adapter.
- 3** Use a soft cloth moistened with water. Do not use liquid or aerosol cleaners.

If any of the following occurs:

- The computer has been dropped or the body has been damaged.
- Liquid has been spilled into the product.
- The computer does not operate normally.

Please refer to "Troubleshooting my computer" on page 41.

Contents

First things first	iii
Your guides	iii
Basic care and tips for using your computer	iv
1 Getting to know your	
TravelMate	1
A TravelMate tour	3
Front view	3
Left view	5
Right view	6
Rear view	7
Bottom view	8
Features	9
Indicators	11
Indicators in cover	12
Using the keyboard	13
Special keys	13
Touchpad	20
Touchpad basics	20
Storage	22
Hard disk	22
Optical drive	22
Audio	24
Power management	24
Moving around with your TravelMate	25
Disconnecting from the desktop	25
Moving around	25
Taking the computer home	26
Traveling with the computer	28
Traveling internationally with the computer	28
Securing your computer	30
Using a computer security lock	30
2 Customizing my computer	31
Expanding through options	33
Connectivity options	33
Upgrade options	36
Using system utilities	38
Notebook Manager	38
Launch Manager	39
BIOS Utility	39

3 Troubleshooting my computer	41
Frequently-asked questions	43
Requesting service	47
International Traveler's Warranty (ITW)	47
Before you call	47
Appendix A Specifications	49
Appendix B Regulation & safety notices	55
Index	69

1 Getting to know your **TravelMate**

Your TravelMate computer combines high-performance, versatility, power management features and multimedia capabilities with a unique style and ergonomic design. Work with unmatched productivity and reliability with your new power computing partner.

A TravelMate tour

After setting up your computer as illustrated in the **Just for starters...** poster, let us show you around your new TravelMate computer.

Front view





#	Item	Description
1	Display screen	Also called Liquid-Crystal Display (LCD), displays computer output.

#	Item	Description
2	Status indicators	Light-Emitting Diodes (LEDs) that turn on and off to show the status of the computer, its functions and components.
3	Power button	Turns on the computer power.
4	Launch Keys	Buttons for launching frequently used programs. See "Launch keys" on page 19 for more details.
5	Palmrest	Comfortable support area for your hands when you use the computer.
6	Click buttons (left, center and right)	The left and right buttons function like the left and right mouse buttons; the center button serves as a 4-way scroll button.
7	Touchpad	Touch-sensitive pointing device which functions like a computer mouse.
8	Keyboard	Inputs data into your computer.
9	Ventilation slot	Enables the computer to stay cool, even after prolonged use.

Left view



#	Item	Description
1	PC Card slots 	Connects to one Type III or two Type II CardBus PC Card(s).
2	Eject buttons	Ejects the PC Card from the slot.
3	Optical drive	Internal optical drive; accepts CDs or DVDs depending on the optical drive type.
4	Infrared port 	Interfaces with infrared devices (e.g., infrared printer, IR-aware computer).
5	Eject button	Ejects the optical drive tray from the drive.
6	LED indicator	Lights up when the optical drive is active.
7	Emergency eject hole	Ejects the optical drive tray when the computer is turned off. See page 44 for more details.
8	Speaker	Delivers stereo audio output.



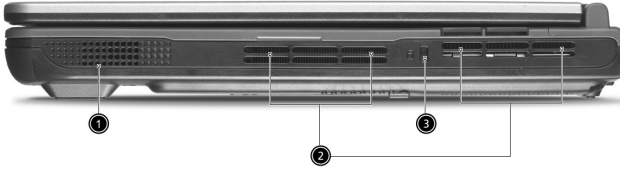



Right view

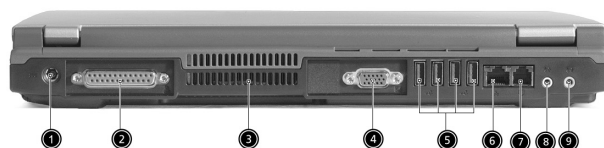



#	Item	Description
1	Speaker	Delivers stereo audio output.
2	Ventilation slots	Enable the computer to stay cool, even after prolonged use.
3	Security keylock	Connects to a Kensington-compatible computer security lock.

Rear view



#	Item	Description
1	Power jack 	Connects to an AC adapter.
2	Parallel port 	Connects to a parallel device (e.g., parallel printer).
3	Ventilation slot	Enables the computer to stay cool, even after prolonged use.
4	External display port 	Connects to a display device (e.g., external monitor, LCD projector) and displays up to 16M colors at 1024x768 resolution.
5	Four USB 2.0 ports 	Connect to Universal Serial Bus (USB) 2.0 devices (e.g., USB mouse, USB camera).
6	Network jack 	Connects to an Ethernet 10/100-based network.
7	Modem jack 	Connects to a phone line.

#	Item	Description
8	Speaker/Line-Out/ Headphone jack	Connects to audio line-out devices (e.g., speakers, headphones).
		
9	Line-in/Mic-in jack	Accepts audio line-in devices (e.g., audio CD player, stereo walkman).
		

Bottom view

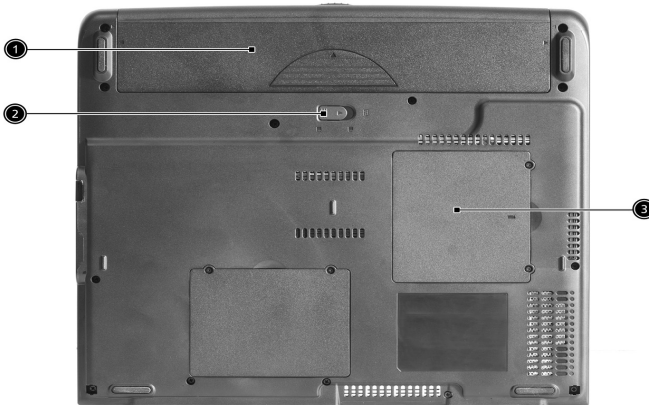

#	Item	Description
1	Battery bay	Houses the computer's battery pack.
2	Battery release latch	Unlatches the battery to remove the battery pack.
3	Memory compartment	Houses the computer's main memory.

Features

Below is a brief summary of the computer's many features:

Performance

- Intel® Pentium® 4 and Intel® Celeron® processors, 2.8 GHz and above
- Intel® Hyper-Threading™ Technology
- 256/512 MB of DDR333 SDRAM standard, upgradeable to 2048 MB with dual soDIMM modules
- 30 GB and above high-capacity, Enhanced-IDE hard disk
- Advanced Configuration Power Interface (ACPI) power management system

Display

- The 14.1" or 15" XGA (1024x768 resolution), or 15.0" SXGA+ (1400x1050 resolution) TFT LCD panel providing a large viewing area for maximum efficiency and ease-of-use
- ATI MOBILITY™ Radeon™ 9000 IGP chipset shared with 64 MB of system memory, as video RAM
- 3D graphics support
- Simultaneous LCD and CRT display support
- "Automatic LCD dim" feature that automatically deciding the best settings for your display and conserves power
- DualView™ support

Multimedia

- High-speed DVD/CD-RW Combo or DVD-Dual drive
- MS DirectSound compatible
- Built-in dual speakers

Connectivity

- Integrated 10/100 Mbps Fast Ethernet connection
- Built-in 56Kbps fax/data modem
- Four Universal Serial Bus (USB) 2.0 ports
- IEEE 802.11b or IEEE 802.11g Wireless LAN (manufacturing option)
- Bluetooth (manufacturing option)

Human-centric design and ergonomics

- Rugged, yet extremely portable design
- Stylish appearance
- Full-size keyboard with four programmable launch keys
- Comfortable palm rest area with well-positioned touchpad







Expansion

- One Type III or two Type II CardBus PC Card slots
- Upgradeable memory modules

Indicators

The computer has seven easy-to-read status icons below the display screen.





Icon	Function	Description
	Wireless communications	Lights when the Wireless LAN capability is enabled.
	Power	Lights when the computer is on.
	Sleep	Lights when the computer enters Standby mode and blinks when it enters into or resumes from hibernation mode.
	Media activity	Lights when the hard disk or optical drive is active.
	Battery charge	Lights when the battery is being charged.
	Caps Lock	Lights when Caps Lock is activated.
	Num Lock	Lights when Num Lock is activated.

Indicators in cover

When the cover of your computer is closed, 2 easy-to-read icons are shown, indicating which state or feature is enabled or disabled.



Icon	Description
	Lights up when the computer is on.
	Lights when the computer enters Standby mode and blinks when it enters into or resumes from hibernation mode.

Using the keyboard

The keyboard has full-sized keys and an embedded keypad, separate cursor keys, two Windows keys and twelve function keys.

Special keys

Lock keys

The keyboard has three lock keys which you can toggle on and off.



Lock Key	Description
Caps Lock	When Caps Lock is on, all alphabetic characters typed are in uppercase.
Num Lock (Fn-F11)	When Num Lock is on, the embedded keypad is in numeric mode. The keys function as a calculator (complete with the arithmetic operators +, -, *, and /). Use this mode when you need to do a lot of numeric data entry. A better solution would be to connect an external keypad.
Scroll Lock (Fn-F12)	When Scroll Lock is on, the screen moves one line up or down when you press the up or down arrow keys respectively. Scroll Lock does not work with some applications.

Embedded numeric keypad

The embedded numeric keypad functions like a desktop numeric keypad. It is indicated by small characters located on the upper right corner of the keycaps. To simplify the keyboard legend, cursor-control key symbols are not printed on the keys.

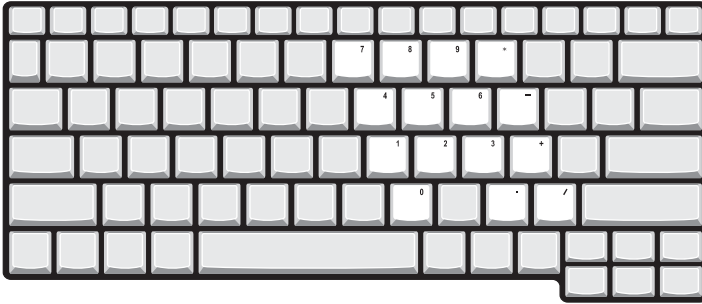

Desired Access	Num Lock On	Num Lock Off
Number keys on embedded keypad	Type numbers in a normal manner.	
Cursor-control keys on embedded keypad	Hold Shift while using cursor-control keys.	Hold Fn while using cursor-control keys.
Main keyboard keys	Hold Fn while typing letters on embedded keypad.	Type the letters in a normal manner.













Note: If an external keyboard or keypad is connected to the computer, the Num Lock feature automatically shifts from the internal keyboard to the external keyboard or keypad.

Windows keys

The keyboard has two keys that perform Windows-specific functions.



Key	Description
Windows key 	Pressed alone, this key has the same effect as clicking on the Windows Start button; it launches the Start menu. It can also be used with other keys to provide a variety of functions: <ul style="list-style-type: none">  + Tab Activates the next Taskbar button.  + E Opens the My Computer window.  + F1 Opens Help and Support.  + F Opens the Find: All Files dialog box.  + M Minimizes all windows. Shift +  + M Undoes the minimize all windows ( + M) action.  + R Opens the Run dialog box.
Application key 	This key has the same effect as clicking the right mouse button; it opens the application's context menu.









Hot keys

The computer employs hot keys or key combinations to access most of the computer's controls like screen brightness, volume output and the BIOS Utility.

To activate hot keys, press and hold the **Fn** key before pressing the other key in the hot key combination.



Hot Key	Icon	Function	Description
Fn-F1	?	Hot key help	Displays help on hot keys.
Fn-F2		Setup	Launches the Notebook Manager.
Fn-F3		Power Management Scheme toggle	Switches the power management scheme used by the computer (function available if supported by operating system).
Fn-F4	Z ^z	Sleep	Puts the computer in Sleep mode.

Hot Key	Icon	Function	Description
Fn-F5		Display toggle	Switches display output between the display screen, external monitor (if connected) and both the display screen and external monitor.
Fn-F6		Screen blank	Turns the display screen backlight off to save power. Press any key to return.
Fn-F7		Touchpad toggle	Turns the internal touchpad on and off.
Fn-F8		Speaker toggle	Turns the speakers on and off.
Fn-↑		Volume up	Increases the sound volume.
Fn-↓		Volume down	Decreases the sound volume.
Fn-→		Brightness up	Increases the screen brightness.
Fn-←		Brightness down	Decreases the screen brightness.
Fn-Pg Up	Pg Up Home	Home	Functions as the Home key.
Fn-Pg Dn	Pg Dn End	End	Functions as the End key.
Alt Gr- Euro	€	Euro	Types the Euro symbol.

The Euro symbol

If your keyboard layout is set to United States-International or United Kingdom or if you have a keyboard with a European layout, you can type the Euro symbol on your keyboard.



.....

Note for US keyboard users: The keyboard layout is set when you first set up Windows. For the Euro symbol to work, the keyboard layout has to be set to United States-International.

To verify the keyboard type:

- 1 Click on **Start, Control Panel**.
- 2 Double-click on **Regional and Language Options**.
- 3 Click on the **Language** tab and click on **Details**.
- 4 Verify that the keyboard layout used for "En English (United States)" is set to United States-International.

If not, select and click on **ADD**; then select **United States-International** and click on **OK**.

- 5 Click on **OK**.

To type the Euro symbol:

- 1 Locate the Euro symbol on your keyboard.
- 2 Open a text editor or word processor.
- 3 Hold **Alt Gr** and press the **Euro** symbol.



.....

Note: Some fonts and software do not support the Euro symbol. Please refer to <http://www.microsoft.com/typography/faq/faq12.htm> for more information.

Launch keys

Located at the top of the keyboard are six buttons. These buttons are called launch keys. They are designated as Wireless, Bluetooth button, Web browser button, mail button, P1 and P2. The Wireless and Bluetooth buttons cannot be set by the user. To set the other four launch keys, run the Acer Launch Manager.



	Description	Default Application
1	Mail	Email application
2	Web browser	Internet browser application
3	P1	User-programmable
4	P2	User-programmable
5	Bluetooth (optional)	Enables your Bluetooth.
6	Wireless (optional)	Enables your 802.11b or 802.11g Wireless LAN.



Caution: It is important that Bluetooth and Wireless LAN are turned off before boarding an airplane.

Touchpad

The built-in touchpad is a PS/2-compatible pointing device that senses movement on its surface. This means the cursor responds as you move your finger on the surface of the touchpad. The central location on the palmrest provides optimum comfort and support.



.....

Note: When using an external USB or serial mouse, you can press **Fn-F7** to disable the touchpad.



Touchpad basics

The following items teach you how to use the touchpad:



- Move your finger across the touchpad to move the cursor.
- Press the left (1) and right (3) buttons located on the edge of the touchpad to do selection and execution functions. These two

buttons are similar to the left and right buttons on a mouse. Tapping on the touchpad produces similar results.

- Use the 4-way scroll (2) button to scroll up or down and move left or right a page. This button mimics your cursor pressing on the right scroll bar of Windows applications.

Function	Left Button	Right Button	Center Button	Tap
Execute	Click twice quickly.			Tap twice (at the same speed as double-clicking a mouse button).
Select	Click once.			Tap once.
Drag	Click and hold, then use finger to drag the cursor on the touchpad.			Tap twice (at the same speed as double-clicking a mouse button) then hold finger to the touchpad on the second tap and drag the cursor.
Access context menu		Click once.		
Scroll			Click and hold the up/ down/ left/ right.	



Note: Keep your fingers dry and clean when using the touchpad. Also keep the touchpad dry and clean. The touchpad is sensitive to finger movements. Hence, the lighter the touch, the better the response. Tapping harder will not increase the touchpad's responsiveness.

Storage

This computer supplies you with the following media storage:

- High-capacity, Enhanced-IDE hard disk
- Optical drive: DVD/CD-RW Combo or DVD-Dual

Hard disk

The high-capacity hard disk is the answer to your storage needs. This is where your data files and applications are stored.

Optical drive

Your computer comes equipped with an optical drive which may be one of the following:

- DVD/CD-RW Combo
- DVD-Dual

Ejecting the DVD tray

To eject the DVD tray when the computer is turned on, press the drive eject button; then pull out the tray.

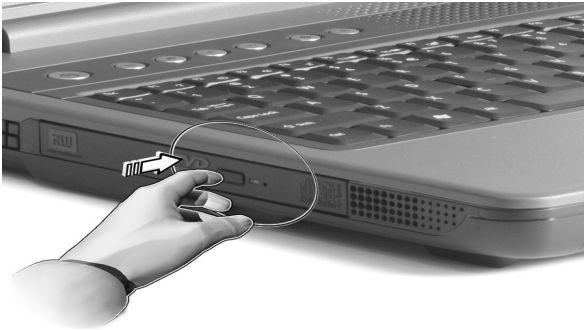

When the power is off, you can eject the drive tray using the emergency eject hole. See page 44.

Playing DVD movies

When the DVD drive module is installed in the optical drive bay, you can play DVD movies on your computer.

- 1 Eject the DVD tray and insert a DVD movie disc; then close the DVD tray.



Important! When you launch the DVD player for the first time, the program asks you to input the region code. DVD discs are divided into 6 regions. Once your DVD drive is set to a region code, it will play DVD discs of that region only. You can set the region code a maximum of five times (including the first time), after which the last region code set will remain permanent. Recovering your hard disk does not reset the number of times the region code has been set. Refer to the table later in this section for DVD movie region code information.

- 2 The DVD movie will automatically play after a few seconds.

Region Code	Country or Region
1	U.S.A., Canada
2	Europe, Middle East, South Africa, Japan
3	Southeast Asia, Taiwan, South Korea
4	Latin America, Australia, New Zealand
5	Former U.S.S.R., parts of Africa, India
6	People's Republic of China



Note: To change the region code, insert a DVD movie of a different region into the DVD drive.

Audio

The computer comes with 16-bit high-fidelity AC'97 stereo audio. The built-in dual stereo speakers are easy to access.



There are audio ports on the rear panel of the computer. See “Rear view” on page 7 for more information on external audio devices.

Power management

This computer has a built-in power management unit that monitors system activity. System activity refers to any activity involving one or more of the following devices: keyboard, mouse, hard disk, peripherals connected to the serial and parallel ports, and video memory. If no activity is detected for a period of time (called an inactivity timeout), the computer stops some or all of these devices in order to conserve energy.

This computer employs a power management scheme that supports Advanced Configuration and Power Interface (ACPI), which allows for maximum power conservation and maximum performance at the same time. Windows handles all power-saving chores for your computer.

Moving around with your TravelMate

This section gives you tips and hints on things to consider when moving around or traveling with your computer.

Disconnecting from the desktop

Follow these steps to disconnect your computer from external accessories:

- 1 Save your work in progress.
- 2 Remove any media or compact disc from the drive(s).
- 3 Shut down the operating system.
- 4 Turn off the computer.
- 5 Close the display cover.
- 6 Disconnect the cord from the AC adapter.
- 7 Disconnect the keyboard, pointing device, printer, external monitor, and other external devices.
- 8 Disconnect the Kensington lock if you are using one to secure the computer.

Moving around

“when you are just moving within short distances, for example, from your office desk to a meeting room”

Preparing the computer

Before moving the computer, close and latch the display cover to place it in Sleep mode. You can now safely take the computer anywhere you go within the building. To bring the computer out of Sleep mode, open the display.

If you are taking the computer to a client's office or a different building, you may choose to shut down the computer:

- 1 Click on **Start, Turn Off Computer**.
- 2 Click on **Turn Off**.

- or -

you can put the computer in Sleep mode by pressing **Fn-F4**. Then close and latch the display.

When you are ready to use the computer again, unlatch and open the display, and press and release the power switch. If the power indicator is off, the computer has entered Hibernation mode and turned off.

Press and release the power switch to turn the computer back on. Note that the computer may enter Hibernation mode after a period of time it is in Sleep mode. Turn the power on to wake up the computer from Hibernation mode.

What to bring to short meetings

A fully charged battery runs the computer for about two hours under most circumstances. If your meeting is shorter than that, you probably do not need to bring anything with you other than the computer.

What to bring to long meetings

If your meeting lasts longer than two hours or if your battery is not fully charged, you may want to bring the AC adapter with you to plug in your computer in the meeting room.

If the meeting room does not have an electrical outlet, reduce the drain on the battery by putting the computer in Sleep mode. Press **Fn-F4** or close the display cover whenever you are not actively using the computer. Then tap any key or open the display to resume.

Taking the computer home

“when you are moving from your office to your home or vice versa”

Preparing the computer

After disconnecting the computer from your desktop, follow these steps to prepare the computer for the trip home:

- Check if you have removed all media and compact discs from the drive(s). Failure to remove the media can damage the drive head.
- Pack the computer in a protective case that can prevent the computer from sliding around and cushion it if it should fall.



Caution: Avoid packing items next to the top cover of the computer. Pressure against the top cover can damage the screen

What to bring with you

Unless you already have some items at home, bring the following items with you:

- AC adapter and power cord
- The printed user's guide

Special considerations

Follow these guidelines to protect your computer while traveling to and from work:

- Minimize the effect of temperature changes by keeping the computer with you.
- If you need to stop for an extended period of time and cannot bring the computer with you, leave the computer in the trunk of the car to avoid exposing the computer to excessive heat.
- Changes in temperature and humidity can cause condensation. Allow the computer to return to room temperature, and inspect the screen for condensation before turning on the computer. If the temperature change is greater than 18°F (10°C), allow the computer to come to room temperature slowly. If possible, leave the computer for 30 minutes in an environment with a temperature between outside and room temperature.

Setting up a home office

If you frequently work on your computer at home, you may want to purchase a second AC adapter for use at home. With a second AC adapter, you can avoid transporting the extra weight to and from home.

If you use your computer at home for significant periods of time, you might also want to add an external keyboard, monitor, or mouse.

Traveling with the computer

“when you are moving within a larger distance, for instance, from your office building to a client’s office building or traveling locally”

Preparing the computer

Prepare the computer as if you were taking it home. Make sure that the battery in the computer is charged. Airport security may require you to turn on your computer when bringing it into the gate area.

What to bring with you

Bring the following items with you:

- AC adapter
- Spare, fully-charged battery pack(s)
- Additional printer driver files if you plan to use another printer

Special considerations

In addition to the guidelines for taking the computer home, follow these guidelines to protect your computer while traveling:

- Always take the computer as carry-on luggage.
- If possible, have the computer inspected by hand. Airport security X-ray machines are safe, but do not put the computer through a metal detector.

Traveling internationally with the computer

“when you are moving from country to country”

Preparing the computer

Prepare the computer as you would normally prepare it for traveling.

What to bring with you

Bring the following items with you:

- AC adapter
- Power cords that are appropriate for the country to which you are traveling
- Spare, fully-charged battery packs
- Additional printer driver files if you plan to use another printer
- Proof of purchase, in case you need to show it to customs officials
- International Traveler's Warranty passport

Special considerations

Follow the same special considerations as when traveling with the computer. In addition, these tips are useful when traveling internationally:

- When traveling in another country, check that the local AC voltage and the AC adapter power cord specifications are compatible. If not, purchase a power cord that is compatible with the local AC voltage. Do not use converter kits sold for appliances to power the computer.
- If you are using the modem, check if the modem and connector is compatible with the telecommunications system of the country you are traveling in.

Securing your computer

Your computer is a valuable investment that you need to take care of. Learn how to protect and take care of your computer.

Security features include hardware and software locks — a security lock and passwords.

Using a computer security lock

A security keylock notch located on the right panel of the computer lets you connect a Kensington-compatible computer security lock.



Wrap a computer security lock cable around an immovable object such as a table or locked drawer handle. Insert the lock into the notch and turn the key to secure the lock. Some keyless models are also available.

Setting a password

Passwords protect your computer from unauthorized access. When set, no one can access the computer without entering the correct password.

There are three types of passwords you can set:

- 1 Supervisor Password secures your computer against unauthorized entry to and use of the BIOS Utility.
- 2 User Password secures your computer against unauthorized use.
- 3 Hard Disk Password protects your data by preventing unauthorized access to your hard disk.



Important! Do not forget your Setup and Hard Disk passwords! If you forget your passwords, please get in touch with your dealer or an authorized service center.

You can set the passwords using the BIOS Utility.

2 Customizing my computer

After learning the basics of your TravelMate computer, let's get acquainted with the advanced features of your computer. In this chapter, you will learn how to add options, upgrade components for better performance, and customize your computer.

Expanding through options

Your TravelMate offers you a complete mobile computing experience.

Connectivity options

Ports allow you to connect peripheral devices to your computer as you would with a desktop PC.

Modem

Your computer has a built-in V.92 56Kbps AC'97 Link modem.



.....
Warning! This modem port is not compatible with digital phone lines. Plugging this modem into a digital phone line will damage the modem.

To use the modem, connect a phone cable from the modem jack to a phone line jack.



See your communications manual for instructions to start the program.

Network

Your computer has built-in Ethernet/Fast Ethernet capabilities. To use the network feature, connect an Ethernet cable from the network jack to an network jack or hub. Consult your network administrator for details.



Universal Serial Bus

The Universal Serial Bus (USB) 2.0 port is a high-speed serial bus which allows you to connect and daisy-chain USB peripherals without taking up precious system resources. Your computer has four ports available.

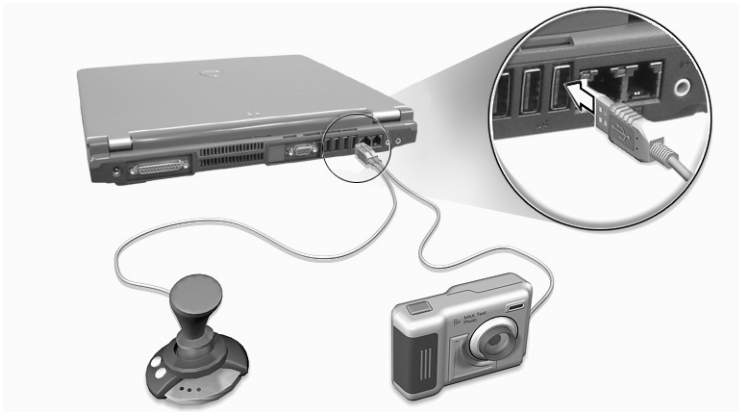

PC Card slot

There are one Type III or two Type II CardBus PC Card slots found on the left side of the computer. The slots accept credit-card-sized cards that enhance the usability and expandability of the computer. These cards should have a PC Card logo on them.

PC Cards (formerly PCMCIA) are add-on cards for portable computers, giving you expansion possibilities long afforded by desktop PCs. CardBus improves on the 16-bit PC card technology by expanding the bandwidth to 32 bits.



Note: Refer to your card manual for details on how to install and use the card and its functions.

Inserting a PC Card

Insert the card into the lower slot and make the proper connections (e.g., network cable), if necessary. See your card manual for details.

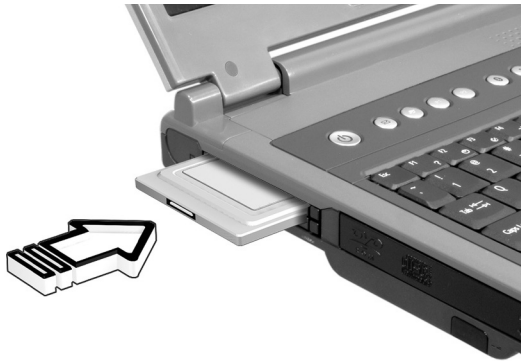

Ejecting a PC Card

Before ejecting a PC Card:

- 1 Exit the application using the card.
- 2 Left-click on the Safely Remove Hardware icon on the taskbar and click on the PC Card item. Click **OK** to confirm.

- 3 Press the slot eject button (1) to pop out the eject button; then press it again to eject the card (2).

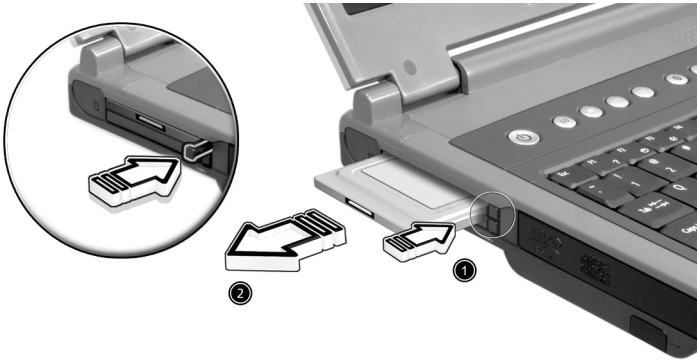

Upgrade options

Your computer delivers superior power and performance. However, some users and the applications they use may demand more. This computer allows you to upgrade key components when you need increased performance.



Note: Contact your authorized dealer if you decide to perform a key component upgrade.

Memory upgrade

Memory is expandable to 2 GB, employing DDR 266/333 256MB/512MB/1GB SDRAM modules. The computer supports shadow RAM.

There are two memory slots on your computer, one of which is occupied by standard memory. You can upgrade memory by installing a memory module into the available slot, or replacing the standard memory with a higher-capacity memory module.

Installing memory

Follow these steps to install memory:

- 1 Turn off the computer, unplug the AC adapter (if connected) and remove the battery pack. Then turn the computer over to access its base.
- 2 Remove the screw from the memory cover (1), then lift up and remove the memory cover (2).

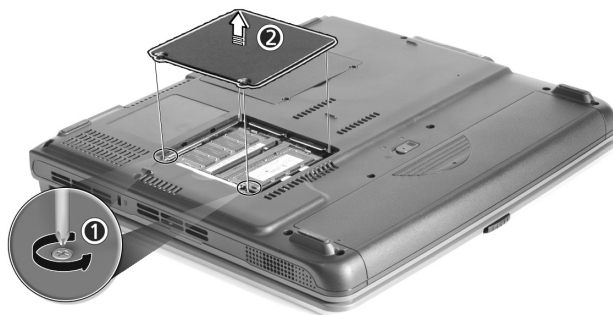

- 3 Insert the memory module diagonally into the slot (1), then gently press it down until it clicks into place (2).

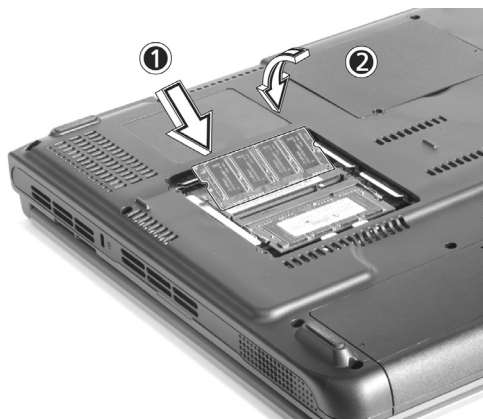

- 4 Replace the memory cover and secure it with the screw.

The computer automatically detects and reconfigures the total memory size.

Using system utilities

Notebook Manager

The computer has a built-in system setup program called Notebook Manager. The Windows-based Notebook Manager allows you to set passwords, the startup sequence of the drives, and power management settings. It also shows current hardware configurations.

To start the Notebook Manager, press **Fn-F2** or follow these steps:

- 1 Click on **Start, All Programs**, then **Notebook Manager**.
- 2 Select the **Notebook Manager** application to run the program.

Click on Help and Support for more information.

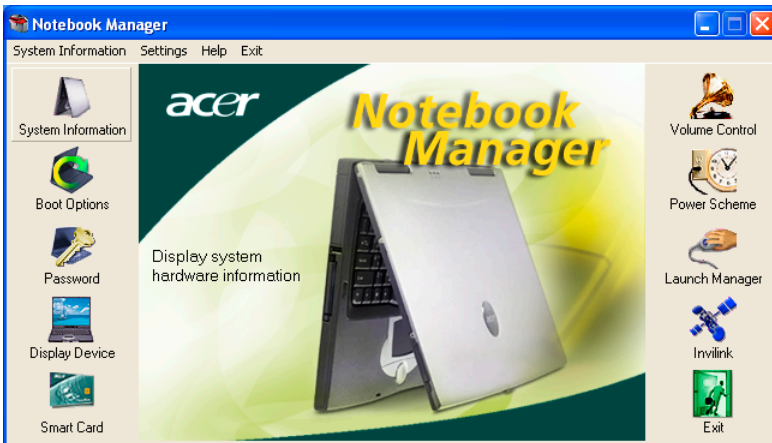

Launch Manager

There are six Launch Keys located above the keyboard. The Wireless and Bluetooth buttons are not programmable. Launch Manager only allows you to set the other four Launch Keys. See "Launch keys" on page 19 for more information.

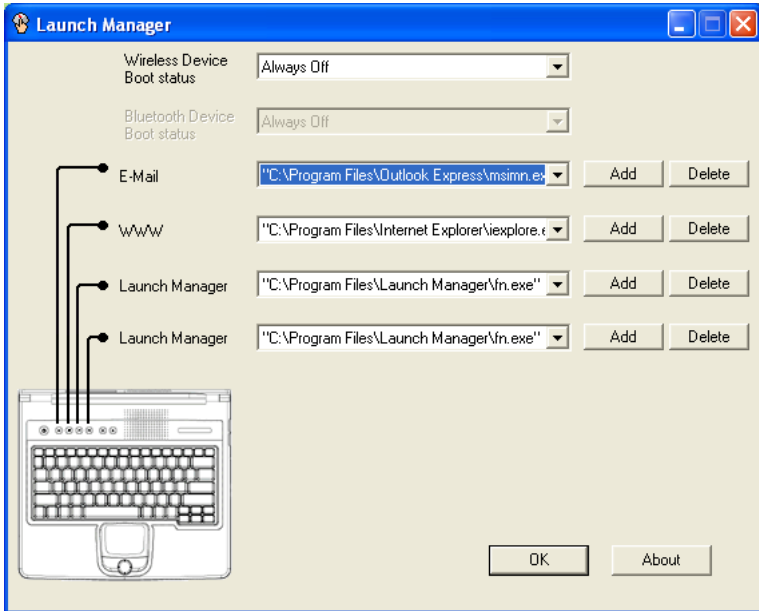

You can access the Launch Manager by clicking on **Start, All Programs,** and then **Launch Manager** to start the application.

BIOS Utility

The BIOS Utility is a hardware configuration program built into your computer's Basic Input/Output System (BIOS).

Your computer is already properly configured and optimized, and you do not need to run this utility. However, if you encounter configuration problems, you may need to run it.

To activate the BIOS Utility, press **F2** during the Power-On Self Test (POST) while the TravelMate logo is being displayed.

3 Troubleshooting my computer

This chapter instructs you on how to deal with common system problems. Read it before calling a technician if a problem occurs. Solutions to more serious problems require opening up the computer. Do not attempt to open the computer by yourself. Contact your dealer or an authorized service center for assistance.

Frequently-asked questions

The following is a list of possible situations that may arise during the use of your computer. Easy answers and solutions are provided for each one.

I pressed the power switch and opened the display, but the computer does not start or boot-up.

Look at the Power indicator:

- If it is not lit, no power is being applied to the computer. Check the following:
 - If you are running on battery power, it may be low and unable to power the computer. Connect the AC adapter to recharge the battery pack.
 - Make sure that the AC adapter is plugged in properly to the computer and to the power outlet.
- If it is lit, check the following:
 - If the Sleep indicator is lit, the computer is in Sleep mode. Press any key or tap on the touchpad to resume.

Nothing appears on the screen.

The computer's power management system automatically blanks the screen to save power. Press any key to turn the display back on.

If pressing a key does not turn the display back on, two things might be the cause:

- The brightness level might be too low. Press **Fn**→ to increase the brightness level.
- The display device might be set to an external monitor. Press the display toggle hot key **Fn-F5** to toggle the display back to the computer.

Image is not full-screen.

Make sure that the resolution is set to 1024x768. This is the native resolution of your computer display. Right-click on your Windows desktop and select Properties to bring up the **Display Properties** dialog box. Then click on the Settings tab to make sure that the resolution is set to the appropriate resolution. Resolutions lower than the specified resolution are not full-screen on the computer or on an external monitor.

No audio is heard from the computer.

Check the following:

- The volume may be muted. In Windows, look at the volume control (speaker) icon on the taskbar. If it is crossed-out, click on the icon and deselect the Mute option.
- The speakers may be turned off. Press **Fn-F8** to turn the speakers on (this hot key also turns the speakers off).
- The volume level may be too low. In Windows, look at the volume control icon on the taskbar.
- If headphones, earphones or external speakers are connected to the line-out port on the computer's right panel, the internal speakers automatically turn off.

I want to eject the CD or DVD tray without turning on the power. I cannot eject the CD or DVD tray.

There is a mechanical eject button on the optical drive. Simply insert the tip of a pen or paperclip and push to eject the tray.

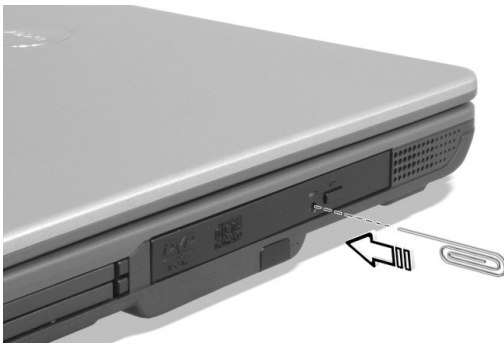

The CD or DVD drive cannot access a disc.

Check the following:

- Make sure the disc is supported by the drive. If your computer has a CD-ROM drive, it can read CDs but cannot read DVDs. If your computer has a DVD drive, it can read DVDs in addition to CDs.
- When placing the CD or DVD in the drive tray, make sure it is secure in the spindle on the drive tray.
- Make sure the CD or DVD is free from scratches or smudges. If the CD or DVD is dirty, clean it using a disc cleaning kit. Remember to follow the instructions included with the kit.
- If the problem does not lie with the disc, your CD or DVD drive may be dirty. Clean it using a drive cleaning kit. Follow the instructions included with the kit.

The keyboard does not respond.

Try attaching an external keyboard to the USB connector on the computer's rear. If it works, contact your dealer or an authorized service center as the internal keyboard cable may be loose.

The serial mouse does not work.

Check the following:

- Make sure that the serial cable is plugged securely into the serial port.
- During the POST, press **F2** to access the BIOS Utility and verify that the serial port is enabled. See "BIOS Utility" on page 39 for more details.

The printer does not work.

Check the following:

- Make sure that the printer is connected to a power outlet and that it is turned on.
- Depending on your connection (USB or parallel), make sure that the printer cable is connected securely to the appropriate port on your computer and the corresponding port on the printer.
- During POST, press **F2** to access the BIOS Utility and verify that the parallel port is enabled if you use a parallel printer.

I want to set up my location to use the internal modem.

To properly use your communications software, you need to set up your location:

- 1 Click on **Start, Control Panel**.
- 2 Double-click on **Phone and Modem Options**.
- 3 Click on the **Dialing Rules** tab and begin setting up your location.

Refer to Windows Help and Support.

Requesting service

International Traveler's Warranty (ITW)

Your computer is backed by an International Traveler's Warranty (ITW) that gives you security and peace of mind when traveling. Our worldwide network of service centers are there to give you a helping hand.

An ITW passport comes with your computer. This passport contains all you need to know about the ITW program. A list of available, authorized service centers is in this handy booklet. Read this passport thoroughly.

Always have your ITW passport on hand, especially when you travel to receive the benefits from our support centers. Place your proof-of-purchase in the flap located inside the front cover of the ITW passport.

If the country you are traveling in does not have an Acer-authorized ITW service site, you can still get in contact with our offices worldwide.

Please consult <http://www.acersupport.com>.

Before you call

Please have the following information available when you call Acer for online service, and please be at your computer when you call. With your support, we can reduce the amount of time a call takes and help solve your problems efficiently.

If there are error messages or beeps reported by your computer, write them down as they appear on the screen (or the number and sequence in the case of beeps).

You are required to provide the following information:

Name: _____

Address: _____

Telephone number: _____

Machine and model type: _____

Serial number: _____

Date of purchase: _____

Appendix A

Specifications

This appendix lists the general specifications of your computer.

Microprocessor

- Intel® Pentium® 4 and Intel® Celeron® processors, 2.8 GHz and above

Memory

- 256/512 MB of DDR333 SDRAM standard, upgradeable to 2048 MB with dual soDIMM modules
- 512 KB flash ROM BIOS

Data storage

- One 30 GB and above E-IDE hard disk (2.5", 9.5mm, UltraDMA-100)
- One internal optical drive

Display and video

- 14.1"/15.0" Thin-Film Transistor (TFT) displaying at 1024x768 XGA or 1400x1050 SXGA+ resolution
- ATI MOBILITY™ Radeon™ 9000 IGP chipset shared with 64 MB of system memory, as video RAM
- Simultaneous LCD and CRT display support
- DualView™ support
- "Automatic LCD dim" feature that automatically deciding the best settings for your display and conserves power

Connectivity

- Integrated 10/100 Mbps Fast Ethernet connection
- Built-in 56Kbps fax/data modem
- Four Universal Serial Bus (USB) 2.0 ports
- IEEE 802.11b or IEEE 802.11g Wireless LAN (manufacturing option)
- Bluetooth (manufacturing option)

Audio

- Two built-in stereo speakers
- MS DirectSound compatible
- Audio ports for line-out, line-in devices

Keyboard and pointing device

- 84/85/88-key Windows keyboard
- Ergonomically-centered touchpad pointing device with scroll function

I/O ports

- One Type III or two type II PC Card slots
- One RJ-11 phone jack (V.92, 56Kbps modem)
- One RJ-45 network jack (Ethernet 10/100 Base-T)
- One DC-in jack (AC adapter)
- One parallel port (ECP/EPP compliant)
- One external monitor port
- One line-out jack (3.5mm minijack)
- One line-in jack (3.5mm minijack)
- One Infrared (FIR) port
- Four USB 2.0 ports

Weight and dimensions

- 14.1" display model:
 - 3.3 kg (7.32 lbs)
 - 326(W) x 290(D) x 38.6(max. H) mm
- 15.0" display model:
 - 3.4 kg (7.50 lbs)
- 326(W) x 290(D) x 38.6(max. H) mm

Environment

- Temperature:
 - Operating: 5°C ~ 35°C
 - Non-operating: -20°C ~ 65°C
- Humidity (non-condensing):
 - Operating: 20% ~ 80% RH
 - Non-operating: 20% ~ 80% RH

System

- Microsoft® Windows® XP Home/Pro
- ACPI 1.0b support
- DMI 2.0-compliant

Power

- 8-cell Li-ion battery pack
- 135W AC adapter 19V

Options

- 256MB/512MB/1GB memory upgrade module
- Additional 135W AC adapter
- Addition Li-ion battery pack

Appendix B

Regulation & safety notices

This appendix lists the general notices for your computer.

Energy Star Guidelines Compliance

As an Energy Star Partner, Acer Inc. has determined that this product meets the Energy Star guidelines for energy efficiency.

FCC notice

This device has been tested and found to comply with the limits for a Class B digital device pursuant to Part 15 of the FCC Rules. These limits are designed to provide reasonable protection against harmful interference in a residential installation. This device generates, uses, and can radiate radio frequency energy and, if not installed and used in accordance with the instructions, may cause harmful interference to radio communications.

However, there is no guarantee that interference will not occur in a particular installation. If this device does cause harmful interference to radio or television reception, which can be determined by turning the device off and on, the user is encouraged to try to correct the interference by one or more of the following measures:

- Reorient or relocate the receiving antenna.
- Increase the separation between the device and receiver.
- Connect the device into an outlet on a circuit different from that to which the receiver is connected.
- Consult the dealer or an experienced radio/television technician for help.

Notice: Shielded cables

All connections to other computing devices must be made using shielded cables to maintain compliance with FCC regulations.

Notice: Peripheral devices

Only peripherals (input/output devices, terminals, printers, etc.) certified to comply with the Class B limits may be attached to this equipment. Operation with non-certified peripherals is likely to result in interference to radio and TV reception.

Caution

Changes or modifications not expressly approved by the manufacturer could void the user's authority, which is granted by the Federal Communications Commission, to operate this computer.

Operation conditions

This device complies with Part 15 of the FCC Rules. Operation is subject to the following two conditions: (1) this device may not cause harmful interference, and (2) this device must accept any interference received, including interference that may cause undesired operation.

Notice: Canadian users

This Class B digital apparatus complies with Canadian ICES-003.

Remarque à l'intention des utilisateurs canadiens

Cet appareil numérique de la classe B est conforme à la norme NMB-003 du Canada.

Declaration of Conformity for EU countries

Hereby, Acer, declares that this TravelMate 2000/2500 series is in compliance with the essential requirements and other relevant provisions of Directive 1999/5/EC. (Please visit www.acer.com/about/certificates/nb for complete documents.)

Modem notices

Notice for USA

This equipment complies with Part 68 of the FCC rules. Located on the bottom side of the modem is a label that contains, among other information, the FCC Registration Number and Ringer Equivalence Number (REN) for this equipment. Upon request, you must provide this information to your telephone company.

If your telephone equipment causes harm to the telephone network, the telephone company may discontinue your service temporarily. If possible, they will notify you in advance. But, if advance notice is not practical, you will be notified as soon as possible. You will also be informed of your right to file a complaint with the FCC.

Your telephone company may make changes in its facilities, equipment, operations, or procedures that could affect the proper functioning of your equipment. If they do, you will be notified in advance to give you an opportunity to maintain uninterrupted telephone service.

If this equipment should fail to operate properly, disconnect the equipment from the phone line to determine if it is causing the problem. If the problem is with the equipment, discontinue use and contact your dealer or vendor.



.....
Caution: To reduce the risk of fire, use only No. 26 AWG or larger UL Listed or CSA Certified Telecommunication Line Cord.

TBR 21

This equipment has been approved [Council Decision 98/482/EC - "TBR 21"] for single terminal connection to the Public Switched Telephone Network (PSTN). However, due to differences between the individual PSTNs provided in different countries, the approval does not, of itself, give an unconditional assurance of successful operation on every PSTN termination point. In the event of problems, you should contact your equipment supplier in the first instance.

List of Applicable Countries

EU member states as of April 2003 are: Belgium, Denmark, Germany, Greece, Spain, France, Ireland, Italy, Luxembourg, the Netherlands, Austria, Portugal, Finland, Sweden, and the United Kingdom. Usage allowed in the countries of European Union, as well as Norway, Switzerland, Iceland and Liechtenstein. This device must be used in strict accordance with the regulations and constraints in the country of use. For further information, please contact local office in the country of use.

Notice for Australia

For safety reasons, only connect headsets with a telecommunications compliance label. This includes customer equipment previously labelled permitted or certified.

Notice for New Zealand

For Modem with approval number PTC 211/03/008

- 1 The grant of a Telepermit for any item of terminal equipment indicates only that Telecom has accepted that the item complies with minimum conditions for connection to its network. It indicates no endorsement of the product by Telecom, nor does it provide any sort of warranty. Above all, it provides no assurance that any item will work correctly in all respects with another item of Telepermitted equipment of a different make or model, nor does it imply that any product is compatible with all of Telecom's network services.
- 2 This equipment is not capable, under all operating conditions, of correct operation at the higher speeds for which it is designed. Telecom will accept no responsibility should difficulties arise in such circumstances.
- 3 Some parameters required for compliance with Telecom's Telepermit requirements are dependent on the equipment (PC) associated with this device. The associated equipment shall be set to operate within the following limits for compliance with Telecom's Specifications:
 - a There shall be no more than 10 call attempts to the same number within any 30 minute period for any single manual call initiation, and
 - b The equipment shall go on-hook for a period of not less than 30 seconds between the end of one attempt and the beginning of the next call attempt.
- 4 Some parameters required for compliance with Telecom's Telepermit requirements are dependent on the equipment (PC) associated with this device. In order to operate within the limits for compliance with Telecom's specifications, the associated equipment shall be set to ensure that automatic calls to different numbers are spaced such that there is not less than 5 seconds between the end of one call attempt and the beginning of another.
- 5 This equipment shall not be set up to make automatic calls to Telecom's 111 Emergency Service.

Important safety instructions

Read these instructions carefully. Save them for future reference.

- 1 Follow all warnings and instructions marked on the product.
- 2 Unplug this product from the wall outlet before cleaning. Do not use liquid cleaners or aerosol cleaners. Use a damp cloth for cleaning.
- 3 Do not use this product near water.
- 4 Do not place this product on an unstable cart, stand, or table. The product may fall, causing serious damage to the product.
- 5 Slots and openings are provided for ventilation; to ensure reliable operation of the product and to protect it from overheating. These openings must not be blocked or covered. The openings should never be blocked by placing the product on a bed, sofa, rug, or other similar surface. This product should never be placed near or over a radiator or heat register, or in a built-in installation unless proper ventilation is provided.
- 6 This product should be operated from the type of power indicated on the marking label. If you are not sure of the type of power available, consult your dealer or local power company.
- 7 Do not allow anything to rest on the power cord. Do not locate this product where persons will walk on the cord.
- 8 If an extension cord is used with this product, make sure that the total ampere rating of the equipment plugged into the extension cord does not exceed the extension cord ampere rating. Also, make sure that the total rating of all products plugged into the wall outlet does not exceed the fuse rating.
- 9 Never push objects of any kind into this product through cabinet slots as they may touch dangerous voltage points or short out parts that could result in a fire or electric shock. Never spill liquid of any kind on the product.
- 10 Do not attempt to service this product yourself, as opening or removing covers may expose you to dangerous voltage points or other risks. Refer all servicing to qualified service personnel.
- 11 Unplug this product from the wall outlet and refer servicing to qualified service personnel under the following conditions:
 - a When the power cord or plug is damaged or frayed.
 - b If liquid has been spilled into the product.
 - c If the product has been exposed to rain or water.

- d If the product does not operate normally when the operating instructions are followed. Adjust only those controls that are covered by the operating instructions since improper adjustment of other controls may result in damage and will often require extensive work by a qualified technician to restore the product to normal condition.
 - e If the product has been dropped or the case has been damaged.
 - f If the product exhibits a distinct change in performance, indicating a need for service.
- 12 The TravelMate 2000/2500 series uses the lithium battery. Replace the battery with the same type as the product's battery we recommend in the product specification list. Use of another battery may present a risk of fire or explosion.
 - 13 **Warning!** Batteries may explode if not handled properly. Do not disassemble or dispose of them in fire. Keep them away from children and dispose of used batteries promptly.
 - 14 Use only the proper type of power supply cord set (provided in your accessories box) for this unit. It should be a detachable type: UL listed/CSA certified, type SPT-2, rated 7A 125V minimum, VDE approved or its equivalent. Maximum length is 15 feet (4.6 meters).
 - 15 Always disconnect all telephone lines from the wall outlet before serving or disassembling this equipment.
 - 16 Avoid using a telephone (other than a cordless type) during an electrical storm. There may be a remote risk of electric shock from lightning.

Laser compliance statement

The CD or DVD drive used with this computer is a laser product. The CD or DVD drive's classification label (shown below) is located on the drive.

CLASS 1 LASER PRODUCT

CAUTION: INVISIBLE LASER RADIATION WHEN OPEN. AVOID EXPOSURE TO BEAM.

APPAREIL A LASER DE CLASSE 1 PRODUIT

LASERATTENTION: RADIATION DU FAISCEAU LASER INVISIBLE EN CAS D'OUVERTURE. EVITER TOUTE EXPOSITION AUX RAYONS.

LUOKAN 1 LASERLAITE LASER KLASSE 1

VORSICHT: UNSICHTBARE LASERSTRAHLUNG, WENN ABDECKUNG GEÖFFNET NICHT DEM STRAHLL AUSSETZEN

PRODUCTO LÁSER DE LA CLASE I

ADVERTENCIA: RADIACIÓN LÁSER INVISIBLE AL SER ABIERTO. EVITE EXPONERSE A LOS RAYOS.

ADVARSEL: LASERSTRÅLING VEDÅBNING SE IKKE IND I STRÅLEN.

VARO! LAVATTAESSA OLET ALLTINA LASERSÄTEILYLLE.

VARNING: LASERSTRÅLNING NÅR DENNA DEL ÅR ÖPPNAD ÅLÅ TUIJOTA SÄTEESEENSTIRRA EJ IN I STRÅLEN

VARNING: LASERSTRÅLNING NAR DENNA DEL ÅR ÖPPNADSTIRRA EJ IN I STRÅLEN

ADVARSEL: LASERSTRÅLING NAR DEKSEL ÅPNESSTIRR IKKE INN I STRÅLEN

LCD pixel statement

The LCD unit is produced with high-precision manufacturing techniques. Nevertheless, some pixels may occasionally misfire or appear as black or red dots. This has no effect on the recorded image and does not constitute a malfunction.

Macrovision copyright protection notice

This product incorporates copyright protection technology that is protected by method claims of certain U.S. patents and other intellectual property rights owned by Macrovision Corporation and other rights owners. Use of this copyright protection technology must be authorized by Macrovision Corporation, and is intended for home and other limited viewing uses only unless otherwise authorized by Macrovision Corporation. Reverse engineering or disassembly is prohibited.

Apparatus Claims of U.S. Patent Nos. 4,631,603, 4,577,216, 4,819,098, 4,907,093, and 6,516,132 licensed for limited viewing uses only.

Radio Device Regulatory Notice

Note: Below regulatory information is for models with wireless LAN and/or Bluetooth™ only.

General

This product complies with the radio frequency and safety standards of any country or region in which it has been approved for wireless use. Depending on configurations, this product may or may not contain wireless radio devices (such as wireless LAN and/or Bluetooth™ modules). Below information is for products with such devices.

European Union (EU)

This device complies with the essential requirements of the European Council Directives listed below:

73/23/EEC Low Voltage Directive



- EN 60950

89/336/EEC Electromagnetic Compatibility (EMC) Directive

- EN 55022
- EN 55024
- EN 61000-3-2/-3

99/5/EC Radio & Telecommunications Terminal Equipment (R&TTE) Directive

- Art.3.1a) EN 60950
- Art.3.1b) EN 301 489 -1/-17
- Art.3.2) EN 300 328-2

   (for 2.4 GHz device)

Note: The applicable number varies according to the different Notified Body ID No. applied to the wireless module installed in this product. These numbers are subject to change without notice.

List of Applicable Countries

EU member states as of April 2003 are: Belgium, Denmark, Germany, Greece, Spain, France, Ireland, Italy, Luxembourg, the Netherlands, Austria, Portugal, Finland, Sweden, and the United Kingdom. Usage allowed in the countries of European Union, as well as Norway, Switzerland, Iceland and Liechtenstein. This device must be used in strict accordance with the regulations and constraints in the country of use. For further information, please contact local office in the country of use.

The FCC RF safety requirement

The radiated output power of Wireless LAN Mini-PCI Card and Bluetooth card is far below the FCC radio frequency exposure limits. Nevertheless, the TravelMate 2000/2500 series shall be used in such a manner that the potential for human contact during normal operation is minimized as follows.

- 1 Users are requested to follow the RF safety instructions on wireless option devices that are included in the user's guide of each RF option device.
- 2 An improper installation or unauthorized use may cause harmful interference to radio communications. Also any tampering of the internal antenna will void the FCC certification and your warranty.

Canada - Low power license-exempt radiocommunication devices (RSS-210)

- a Common information
Operation is subject to the following two conditions:
 1. This device may not cause interference, and
 2. this device must accept any interference, including interference that may cause undesired operation of the device.
- b Operation in 2.4 GHz band
To prevent radio interference to the licensed service, this device is intended to be operated indoors and installed outdoors is subject to licensing.

Exposure of humans to RF fields (RSS-102)

TravelMate 2000/2500 series employs low gain integral antennas that do not emit RF field in excess of Health Canada limits for the general population; consult Safety Code 6, obtainable from Health Canada's Web site at www.hc-sc.gc.ca/rpb.

Federal Communications Commission Declaration of Conformity

This device complies with Part 15 of the FCC Rules. Operation is subject to the following two conditions: (1) this device may not cause harmful interference, and (2) this device must accept any interference received, including interference that may cause undesired operation.

The following local Manufacturer/Importer is responsible for this declaration:

Product:	Notebook Personal Computer
Model Number:	MS2154
Machine Type:	TravelMate 2000; TravelMate 2500
SKU Number:	TravelMate 200xxx; TravelMate 250xxx ("x" = 0~9, a~z, or A~Z)
Name of Responsible Party:	Acer America Corporation
Address of Responsible Party:	2641 Orchard Parkeay, San Jose CA 95134, U. S. A.
Contact Person:	Mr. Young Kim
Phone No.:	408-922-2909
Fax No.:	408-922-2606



Acer Incorporated
8F, 88, Sec. 1, Hsin Tai Wu Rd., Hsichih
Taipei Hsien 221, Taiwan, R.O.C.

Tel : 886-2-2696-1234
Fax : 886-2-2696-3535
www.acer.com



Declaration of Conformity for CE marking

We,

Acer Inc.
8F, 88, Sec. 1, Hsin Tai Wu Rd., Hsichih,
Taipei Hsien 221, Taiwan, R. O. C.

Contact Person: Mr. Easy Lai
Tel: 886-2-8691-3089 Fax: 886-2-8691-3000
E-mail: easy_lai@acer.com.tw

Hereby declare that:

Product:	Notebook PC
Trade Name:	Acer
Model Number:	MS2154
Machine Type:	TravelMate 2000; TravelMate 2500
SKU Number:	TravelMate 200xxx; TravelMate 250xxx ("x" = 0~9, a~z, or A~Z)

Is in compliance with the essential requirements and other relevant provisions of the following EC directives.

Reference No.	Title
89/336/EEC	Electromagnetic Compatibility (EMC directive)
73/23/EEC	Low Voltage Directive (LVD)
1999/5/EC	Radio & Telecommunications Terminal Equipment Directive (R&TTE)

The product specified above was tested conforming to the applicable Rules under the most accurate measurement standards possible, and that all the necessary steps have been taken and are in force to assure that production units of the same product will continue to comply with the requirements.

Easy Lai

Easy Lai / Director
Qualification Center
Product Assurance, Acer Inc.

2004/3/5

Date

Index

A

- AC adapter
 - caring for v
- audio 24
 - troubleshooting 44

B

- battery pack
 - caring for v
 - charging indicator 11
- BIOS Utility 39
- BIOS utility 39
- brightness
 - hotkeys 17

C

- caps lock 13
 - on indicator 11
- care

- AC adapter v
- battery pack v
- computer iv

CD

- troubleshooting 45

CD-ROM

- ejecting 22
- ejecting manually 44
- troubleshooting 44

cleaning

- computer v

computer

- bringing to meetings 26
- caring for iv
- cleaning v
- disconnecting 25
- features 3, 9
- indicators 11
- keyboards 13
- moving around 25
- on indicator 11
- performance 9
- security 30
- setting up a home office 27
- taking home 26
- traveling internationally 28

- traveling on local trips 28
- troubleshooting 42
- turning off iv

D

- display
 - hotkeys 17
 - troubleshooting 43, 44
- DVD 23
 - troubleshooting 45
- DVD movies
 - playing 23

E

- Ethernet 34
- Euro 17, 18

F

- FAQ. See frequently-asked questions
- frequently-asked questions 43
- front view 3

H

- hard disk 22
- Hibernation mode
 - hotkey 16
- hotkeys 16

I

- indicator lights 11
- ITW. See warranty

K

- keyboard 13
 - embedded numeric keypad 14
 - hotkeys 16
 - lock keys 13
 - troubleshooting 45
 - Windows keys 15

L

- LEDs 11

M

- media access
 - on indicator 11
- memory
 - installing 37
 - upgrading 36
- modem 33

mouse
troubleshooting 45

N

network 34
Notebook Manager 38
hotkey 16
notice
DVD copyright protection 63
num lock 13
on indicator 11
numeric keypad
embedded 14
num lock 14

O

optical drive 22
options
memory upgrade 36

P

PC Card 35
ejecting 35
inserting 35
ports 33
Power-On Self-Test (POST) 39
printer
troubleshooting 45
problems 43
CD 45
CD-ROM 44
display 43, 44
DVD 45
keyboard 45
printer 45
serial mouse 45
startup 43
troubleshooting 42

Q

questions
setting location for modem use
46

S

safety
CD or DVD 62
FCC notice 57

general instructions 60
modem notices 58
scroll lock 13
security
keylock 30
service
when to call vi
speakers
hotkey 17
troubleshooting 44
specifications 50
Standby mode
hotkey 16
status indicator 11
status indicators 11
storage 22
CD, DVD, or DVD/CD-RW Combo
drive 22
hard disk 22
support
information 47

T

touchpad 20
hotkey 17
using 20
travel
international flights 28
local trips 28
troubleshooting 42

U

universal serial bus 34
utility
BIOS Setup 39

V

view
front 5
left 5
rear 7
right 6

W

warranty
International Traveler's Warrant-
ty 47
Windows keys 15