

TravelMate 3000 Series

User's Guide

Copyright © 2005. Acer Incorporated.
All Rights Reserved.

TravelMate 3000 Series User's Guide
Original Issue: January 2005

Changes may be made periodically to the information in this publication without obligation to notify any person of such revisions or changes. Such changes will be incorporated in new editions of this manual or supplementary documents and publications. This company makes no representations or warranties, either expressed or implied, with respect to the contents hereof and specifically disclaims the implied warranties of merchantability or fitness for a particular purpose.

Record the model number, serial number, purchase date, and place of purchase information in the space provided below. The serial number and model number are indicated on the label affixed to your computer. All correspondence concerning your unit should include the serial number, model number, and purchase information.

No part of this publication may be reproduced, stored in a retrieval system, or transmitted, in any form or by any means, electronically, mechanically, by photocopy, recording, or otherwise, without the prior written permission of Acer Incorporated.

TravelMate 3000 Series Notebook Computer

Model Number: _____

Serial Number: _____

Purchase Date: _____

Place of Purchase: _____

Acer and the Acer Logo are registered trademarks of Acer Inc. Other companies' product names or trademarks are used herein for identification purposes only and belong to their respective companies.

First things first

We would like to thank you for making the TravelMate series of notebook computers your choice for your mobile computing needs.

Your guides

To help you use your TravelMate, we have designed a set of guides:



First off, the **Just for starters...** poster helps you get started with setting up your computer.



The printed **User's Guide** introduces you to the basic features and functions of your new computer. For more on how your computer can help you to be more productive, please refer to the **AcerSystem User's Guide**. This guide contains detailed information on such subjects as system utilities, data recovery, expansion options, and troubleshooting. In addition it contains warranty information and the general regulations and safety notices for your notebook. It is available in Portable Document Format (PDF) and comes preloaded on your notebook. Follow these steps to access it:

- 1 Click on **Start, All Programs, AcerSystem**.
- 2 Click on **AcerSystem User's Guide**.

Note: Viewing the file requires Adobe Acrobat Reader. If Adobe Acrobat Reader is not installed on your computer, clicking on **AcerSystem User's Guide** will run the Acrobat Reader setup program first. Follow the instructions on the screen to complete the installation. For instructions on how to use Adobe Acrobat Reader, access the **Help and Support** menu.

Basic care and tips for using your computer

Turning your computer on and off

To turn on the computer, simply press and release the power button below the LCD screen beside the launch keys. See "**Front view**" on **page 1** for the location of the power button.

To turn the power off, do any of the following:

- Use the Windows shutdown command

Click on **Start, Turn Off Computer**; then click on **Turn Off**.

- Use the power button



.....
Note: You can also use the power button to perform power management functions. See "**Moving around**" on **page 27** of the **AcerSystem User's Guide**.

- Use the customized functions for power management

You can also shut down the computer by closing the display cover, or by pressing the sleep hot key **<Fn>+<F4>**. See "**Moving around**" on **page 27** of the **AcerSystem User's Guide**.



.....
Note: If you cannot power off the computer normally, press and hold the power button for more than four seconds to shut down the computer. If you turn off the computer and want to turn it on again, wait at least two seconds before powering up.

Taking care of your computer

Your computer will serve you well if you take care of it.

- Do not expose the computer to direct sunlight. Do not place it near sources of heat, such as a radiator.
- Do not expose the computer to temperatures below 0°C (32°F) or above 50°C (122°F).
- Do not subject the computer to magnetic fields.
- Do not expose the computer to rain or moisture.
- Do not spill water or any liquid on the computer.
- Do not subject the computer to heavy shock or vibration.

- Do not expose the computer to dust and dirt.
- Never place objects on top of the computer.
- Do not slam the computer display when you close it.
- Never place the computer on uneven surfaces.

Taking care of your AC adaptor

Here are some ways to take care of your AC adaptor:

- Do not connect the adaptor to any other device.
- Do not step on the power cord or place heavy objects on top of it. Carefully route the power cord and any cables away from foot traffic.
- When unplugging the power cord, do not pull on the cord itself but pull on the plug.
- The total ampere ratings of the equipment plugged in should not exceed the ampere rating of the cord if you are using an extension cord. Also, the total current rating of all equipment plugged into a single wall outlet should not exceed the fuse rating.

Taking care of your battery pack

Here are some ways to take care of your battery pack:

- Use only batteries of the same kind as replacements. Turn the power off before removing or replacing batteries.
- Do not tamper with batteries. Keep them away from children.
- Dispose of used batteries according to local regulations. Recycle if at all possible.

Cleaning and servicing

When cleaning the computer, follow these steps:

- 1 Power off the computer and remove the battery pack.
- 2 Disconnect the AC adaptor.
- 3 Use a soft, moist cloth. Do not use liquid or aerosol cleaners.

If any of the following occurs:

- The computer has been dropped or the body has been damaged.
- The computer does not operate normally.

Please refer to **"Frequently-asked questions" on page 47.**

Caution

Changes or modifications not expressly approved by the manufacturer could void the user's authority, which is granted by the Federal Communications Commission, to operate this computer.

Operation conditions

This device complies with Part 15 of the FCC Rules. Operation is subject to the following two conditions: (1) this device may not cause harmful interference, and (2) this device must accept any interference received, including interference that may cause undesired operation.

Users are requested to follow the RF safety instructions on wireless option devices that are included in the user's manual of each RF option device.

An improper installation or unauthorized use may cause harmful interference to radio communications. Also any tampering of the internal antenna will void the FCC certification and your warranty.

To prevent radio interference to the licensed service, this device is intended to be operated indoors and installation outdoors is subject to licensing.

For more information about our products, services, and support information, please visit our website: <http://global.acer.com>.

First things first	iii
Your guides	iii
Basic care and tips for using your computer	iv
Turning your computer on and off	iv
Taking care of your computer	iv
Taking care of your AC adaptor	v
Taking care of your battery pack	v
Cleaning and servicing	v
A TravelMate tour	1
Front view	1
Closed front view	3
Left view	4
Right view	5
Rear view	6
Bottom view	7
Specifications	8
Indicators	12
Using the keyboard	13
Lock keys	13
Embedded numeric keypad	14
Windows keys	15
Hot keys	16
The Euro symbol	18
Launch keys	19
Touchpad	20
Touchpad basics	20
Ejecting the optical (CD or DVD) drive tray	22
Using a computer security lock	22
Audio	23
Adjusting the volume	23
Using system utilities	24
Acer eManager	24
Acer GridVista (dual-display compatible)	25
Launch Manager	26
Moving around with your notebook PC	27
Disconnecting from the desktop	27
Moving around	27
Preparing the computer	27
What to take to short meetings	28
What to bring to long meetings	28
Taking the computer home	29
Preparing the computer	29
What to take with you	29
Special considerations	29

Contents

Setting up a home office	30
Traveling with the computer	30
Preparing the computer	30
What to take with you	30
Special considerations	30
Traveling internationally with the computer	31
Preparing the computer	31
What to bring with you	31
Special considerations	31
Securing your computer	32
Using a computer security lock	32
Using passwords	32
Entering passwords	33
Setting passwords	33
Expanding through options	35
Connectivity options	35
Fax/Data modem	35
Built-in network feature	36
Fast Infrared	36
Universal Serial Bus	37
IEEE 1394 port	37
PC Card slot	38
Installing memory	39
BIOS utility	39
Boot sequence	40
Disc to disc recovery enable	40
Password	40
Using software	40
Playing DVD movies	40
Power management	41
Acer eRecovery	42
Create backup	42
Restore from backup	43
Create factory default image CD	43
Re-install bundled software without CD	44
Change password	44
Acer disc-to-disc recovery	45
Multilingual operating system installation	45
Restore without a Recovery CD	46
Troubleshooting	47
Frequently-asked questions	47
Troubleshooting tips	50
Error messages	51
Requesting service	52

International Travelers Warranty (ITW)	52
Before you call	52
Regulations and safety notices	53
Energy Star Guidelines Compliance	53
FCC notice	53
Modem notices	55
Important safety instructions	58

A TravelMate tour

After setting up your computer as illustrated on the **Just for Starters...** poster, let us show you around your new TravelMate computer.

Front view







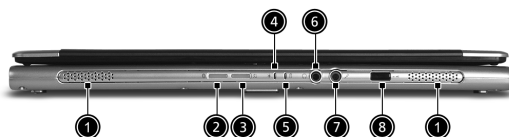

#	Item	Description
1	Display screen	Also called Liquid-Crystal Display (LCD), displaying computer output.
2	Launch keys	Buttons for launching frequently used programs. See "Launch keys" on page 19 for more details.
3	Status indicators	Light-Emitting Diodes (LEDs) that turn on and off to show the status of the computer's functions and components.
4	Palmrest	Comfortable support area for your hands when you use the computer.

#	Item	Description
5	Click buttons (left, center and right)	The left and right buttons function like the left and right mouse buttons; the center button serves as a 4-way scroll button.
6	Touchpad	Touch-sensitive pointing device which functions like a computer mouse.
7	Microphone	Internal microphone for sound recording.
8	Keyboard	Inputs data into your computer.
9	Power button	Turns the computer on and off.





Closed front view

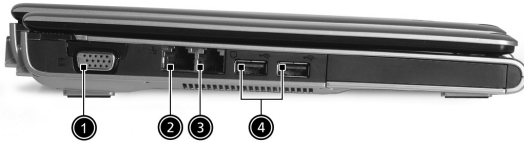

#	Item		Description
1	Speakers		Left and right speakers deliver stereo audio output.
2	Bluetooth® communication button/indicator		Press to enable/disable Bluetooth® function. Lights to indicate the status of Bluetooth® communications (manufacturing option).
3	Wireless communication button/indicator		Press to enable/disable Wireless function. Lights to indicate the status of wireless LAN communications (manufacturing option).
4	Power indicator		Lights when the computer is on.
5	Battery indicator		Lights when the battery is being charged.
6	Headphones/speaker/line-out jack		Connects to audio line-out devices (e.g., speakers, headphones).
7	Microphone line-in jack		Accepts audio line-in devices (e.g., audio CD player, stereo walkman).
8	Infrared port		Interfaces with infrared devices (e.g., infrared printer and IR-aware computer).

Left view



#	Item		Description
1	External display port		Connects to a display device (e.g., external monitor, LCD projector).
2	Network jack		Connects to an Ethernet 10/100/1000-based network.
3	RJ-11 modem jack		Connects to a phone line.
4	Two USB 2.0 ports		Connects to Universal Serial Bus (USB) 2.0 devices (e.g., USB mouse, USB camera).

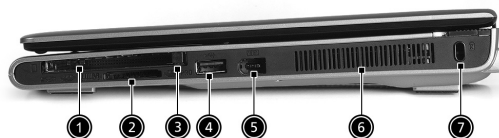

Right view



#	Item	Description
1	PC Card slot	Connects to one Type II CardBus PC Card.
2	4-in-1 card reader	Accepts MS, MS PRO, MMC and SD card. Note: Only one card can operate at any given time.
3	PC Card slot eject button	Ejects the PC Card from the slot.
4	One USB 2.0 port	Connect to Universal Serial Bus (USB) 2.0 devices (e.g., USB mouse, USB camera).
5	IEEE 1394 port	Connects to IEEE 1394 devices.
6	Ventilation slots	Enable the computer to stay cool.
7	Security keylock	Connects to a Kensington-compatible computer security lock.

Rear view



#	Item		Description
1	Power jack		Connects to an AC adaptor.
2	Battery bay		Houses the computer's battery pack.
3	124-pin Acer ezDock connector		Connects to Acer ezDock.

Bottom view



#	Item	Description
1	Battery bay	Houses the computer's battery pack.
2	Battery lock	Locks the battery in place.
3	Cooling fan	Helps keep the computer cool. Note: Do not cover or obstruct the opening of the fan.
4	Ventilation slots	Enable the computer to stay cool.
5	Memory compartment	Houses the computer's main memory.
6	Battery release latch	Unlatches the battery to remove the battery pack.

Specifications

Operating system

- Microsoft® Windows® XP Home/Professional Service Pack 2 Edition

Microprocessor

- Intel® Pentium® M processor 730/740/750/760/770 with Intel® Centrino™ mobile technology at 1.6/1.73/1.86/2.0/2.13 GHz
- Intel® Celeron® M processor 350/360/370 (1 MB L2 cache, 1.3/1.4/1.5 GHz, 400 MHz FSB)

Memory

- 256/512 MB of DDR2 533 SDRAM standard, upgradeable to 2 GB with dual soDIMM modules

Data storage

- One 40/60/80 GB ATA/100 hard disc drive
- One external IEEE 1394 optical drive (DVD-Dual or DVD/CD-RW combo)
- 4-in-1 card reader supports Memory Stick, Memory Stick PRO, Multimedia Card (MMC), and Secure Digital (SD) cards.

Display and video

- 12.1" WXGA color TFT LCD (1280 x 800) or 12.1" WXGA Acer CrystalBrite color TFT LCD (1280 x 768) pixel resolution, 16.7 million colors
- Intel® 915GM integrated 3D graphics with 128 MB of video memory, supporting Intel® Graphics Media Accelerator 900 and Microsoft® DirectX® 9.0
- Simultaneous LCD and CRT display support
- DualView™ support
- MPEG-2/DVD hardware-assisted capability

Connectivity

- LAN: 10/100/1000 Mbps gigabit Ethernet connection
- Modem: 56K ITU V.92 modem with PTT approval
- Wireless LAN (manufacturing option):
 - Integrated Intel® PRO/Wireless 2200BG network connection (dual-band 802.11b/g) Wi-Fi CERTIFIED™ solution; supporting Acer SignalUp wireless technology
 - Integrated Intel® PRO/Wireless 2915ABG network connection (dual-band tri-mode 802.11a/b/g) Wi-Fi CERTIFIED™ solution; supporting Acer SignalUp wireless technology
- Wireless PAN (manufacturing option): integrated Bluetooth®

Audio

- Audio system with built-in speakers and microphone
- Intel® high-definition audio support
- Sound Blaster® Pro and MS-Sound compatible
- S/PDIF (Sony/Philips Digital Interface) support for digital speakers

Keyboard and pointing device

- 84/85-key Windows keyboard with 12 function and embedded numeric keypad
- Built-in touchpad with buttons and 4-way integrated scroll key
- 12 function keys; 4 cursor keys; 2 Windows keys; hotkey controls
- Four easy-launch buttons: Email, Internet browser, Acer Empowering Key, and one user-programmable button
- Two front-access buttons: WLAN LED-button and Bluetooth® LED-button

I/O ports

- Three USB 2.0 ports
- One Type II PC Card slot
- One IEEE 1394 port
- One RJ-11 modem port
- One RJ-45 Ethernet port
- One DC-in jack for AC adaptor
- One 124-pin Acer ezDock connector (for selected models)
- One monitor (VGA) port
- One headphones/speaker/line-out jack with S/PDIF support
- One microphone/line-in jack
- One Infrared (FIR) port
- 4-in-1 MS/MS PRO/MMC/SD card reader

Weight

- 1.40 kg (3.08 lbs) with 3-cell Li-ion battery pack
- 1.55 kg (3.41 lbs) with 6-cell Li-ion battery pack

Dimensions

- 210 (W) x 297.5 (D) x 25/32.5 (H) mm

Environment

- Temperature:
 - Operating: 5°C - 35°C, Non-operating: -10°C - 65°C
- Humidity (non-condensing):
 - Operating: 20% - 80% RH, Non-operating: 20% - 80% RH

System compliance

- ACPI 1.0b
- Mobile PC 2001
- DMI 2.0
- Wi-Fi®
- CCX-V3

Power

- 3-cell Li-ion battery pack
- 6-cell Li-ion battery pack (optional)
- 3-pin 65 W AC adaptor (optional)

Options

- 512 MB/1 GB DDR2 533 MHz soDIMM module
- Additional 6-cell Li-ion battery pack
- Additional 65 W AC adaptor
- DVD-Dual drive
- Acer ezDock



.....
Note: The specifications listed above are for reference only. The exact configuration of your PC depends on the model purchased.

Indicators

The computer has three easy-to-read status indicators on the left side of the keyboard, and four located on the front of the computer.



The power, battery, and wireless communication status indicators are visible even when the LCD display is closed.

Icon	Function	Description
	Caps Lock	Lights when Caps Lock is activated.
	Num Lock	Lights when Num Lock is activated.
	HDD	Lights when hard disc drive is active.
	Bluetooth® communications	Lights to indicate the status of Bluetooth® communications.
	Wireless communications	Lights to indicate the status of Wireless LAN communications.
	Power indicator	Lights when the computer is on.
	Battery indicator	Lights when the battery is being charged.



1. **Charging:** the light shows amber when the battery is charging.
2. **Fully charged:** light shows green when in AC mode.

Using the keyboard

The full-sized keyboard includes an embedded numeric keypad, separate cursor keys, two Windows keys and twelve function keys.

Lock keys

The keyboard has three lock functions which you can toggle on and off.



Lock key	Description
Caps Lock	When Caps Lock is on, all alphabetic characters entered are in uppercase.
Num Lock <Fn>+<F11>	When Num Lock is on, the embedded keypad is in numeric mode. The marked keys function as a numeric keypad (complete with the arithmetic operators +, -, *, and /). Use this mode when you need to do a lot of numeric data entry. An alternative solution may be to connect an external keypad.
Scroll Lock <Fn>+<F12>	When Scroll Lock is on, the screen moves one line up or down when you press the up or down arrow keys respectively. Scroll Lock does not work with some applications.

Embedded numeric keypad

The embedded numeric keypad functions like a desktop PC's numeric keypad. It is indicated by small characters located on the right-hand side of the keycaps.











Desired action	Num Lock on	Num Lock off
Type numbers	Use embedded keypad in the same way as the numeric keypad on a standard keyboard.	
Type letters	Hold <Fn> while pressing the key within the embedded keypad.	Type the letters in a normal manner.

Windows keys

The keyboard also has two keys that perform Windows-specific functions.



Key	Description
Windows logo key 	Start button. Combinations with this key perform shortcut functions. Below are a few examples:  +<Tab> (Activates next taskbar button)  +<E> (Explore My Computer)  +<F> (Find document)  +<F1> (Opens Help and Support)  +<M> (Minimise all) <Shift>+  +<M> (Undoes minimise all)  +<R> (Displays the Run dialog box)
Application key 	Opens a context menu (same as a right-click).







Hot keys

The computer employs hot keys or key combinations to access most of the computer's controls like screen brightness, volume output and the BIOS utility.

To activate hot keys, press and hold the <Fn> key before pressing the other key in the hot key combination.



Hot key	Icon	Function	Description
Fn+F1	?	Hot key help	Displays help on hot keys.
Fn+F2		Acer eSetting	Launches the Acer eSetting in the Acer eManager set by the Acer Empowering Key "e." See " Acer eManager " on page 24.
Fn+F3		Acer ePowerManagement	Launches the Acer ePower-Management in the Acer eManager set by the Acer Empowering Key "e." See " Acer eManager " on page 24.
Fn+F4	Z ^Z	Sleep	Puts the computer in Sleep mode.
Fn+F5		Display toggle	Switches display output between the display screen, external monitor (if connected) and both the display screen and external monitor.
Fn+F6		Screen blank	Turns the display screen backlight off to save power. Press any key to return.

Hot key	Icon	Function	Description
Fn+F7		Touchpad toggle	Turns the internal touchpad on and off.
Fn+F8		Speaker toggle	Turns the speakers on and off.
Fn+↑		Volume up	Increases the speaker volume.
Fn+↓		Volume down	Decreases the speaker volume.
Fn+ →		Brightness up	Increases the screen brightness.
Fn+ ←		Brightness down	Decreases the screen brightness.

The Euro symbol

If your keyboard layout is set to United States-International, United Kingdom or if you have a keyboard with a European layout, you can type the Euro symbol on your keyboard.

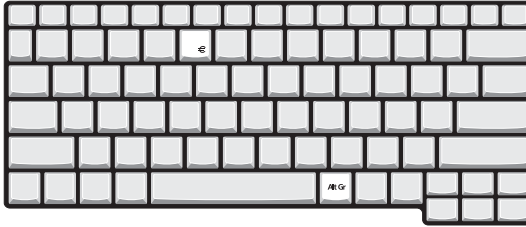

Note for US keyboard users: The keyboard layout is set when you first set up Windows. For the Euro symbol to work, the keyboard layout has to be set to United States-International.

To verify the keyboard type in Windows® XP, follow the steps below:

- 1 Click on **Start, Control Panel**.
- 2 Double-click on **Regional and Language Options**.
- 3 Click on the **Language** tab and click on **Details**.
- 4 Verify that the keyboard layout used for "English (United States)" is set to United States-International.

If not, select and click on **ADD**; then select **United States-International** and click on **OK**.

- 5 Click on **OK**.

To type the Euro symbol:

- 1 Locate the Euro symbol on your number five key.
- 2 Open a text editor or word processor.
- 3 Hold **<Alt Gr>** and press the Euro symbol.



Note: Some fonts and software do not support the Euro symbol. Please refer to www.microsoft.com/typography/faq/faq12.htm for more information.

Launch keys

The four launch keys are located above the keyboard on the left hand side. They are designated as the mail button, the Web browser, the Acer Empowering Key " *e* ", and a user programmable button.

Press the Acer Empowering Key " *e* " to run Acer eManager. Please see "**Acer eManager**" on page 24. The mail and Web browser are default for Email and Internet programs, but can be reset by users. To set the Web browser, mail and programmable keys, run the Acer Launch Manager. See "**Launch Manager**" on page 26.



Launch key	Default application
Email	Email application
Web browser	Internet browser
<i>e</i>	Acer eManager application
P	User-programmable

Touchpad

The built-in touchpad is a pointing device that senses movement on its surface. This means the cursor responds as you move your finger on the surface of the touchpad. The central location on the palmrest provides optimum comfort and support.



Touchpad basics

The following items teach you how to use the touchpad:



- Move your finger across the touchpad **(2)** to move the cursor.
- Press the left **(1)** and right **(4)** buttons located on the edge of the touchpad to perform selection and execution functions. These two buttons are similar to the left and right buttons on a mouse. Tapping on the touchpad is the same as clicking the left button.
- Use the 4-way scroll **(3)** center button to scroll up or down and move left or right a page. This button mimics your cursor pressing on the right scroll bar of Windows applications.

Function	Left button (1)	Right button (4)	Main touchpad (2)	Center button (3)
Execute	Click twice quickly.		Tap twice (at the same speed as double-clicking a mouse button).	
Select	Click once.		Tap once.	
Drag	Click and hold, then use finger to drag the cursor on the touchpad.		Tap twice (at the same speed as double-clicking a mouse button); hold finger to the touchpad on the second tap and drag the cursor.	
Access context menu		Click once.		
Scroll				Click and hold the up/down/left/right.



Note: Keep your fingers dry and clean when using the touchpad. Also keep the touchpad dry and clean. The touchpad is sensitive to finger movement, hence, the lighter the touch, the better the response. Tapping harder will not increase the touchpad's responsiveness.

Ejecting the optical (CD or DVD) drive tray

To eject the tray of an external IEEE 1394-compatible optical drive, press the eject button on the external drive (PC must be powered on).



When the power is off, you can eject the drive tray using the emergency eject hole.

Insert a straightened paperclip into the hole to perform an eject.

Using a computer security lock

A security keylock notch, located on the right hand side of the computer, lets you connect a Kensington-compatible computer security lock.



Wrap a computer security lock cable around an immovable object such as a table or handle of a locked drawer. Insert the lock into the notch and turn the key to secure the lock. Some keyless models are also available.

Audio

The computer comes with Intel® high-definition audio, and dual stereo speakers.

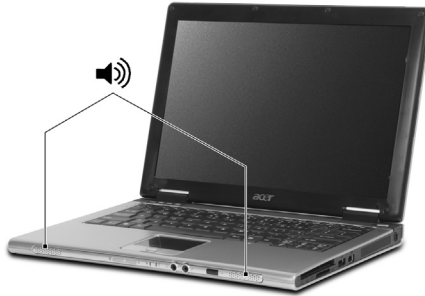

Adjusting the volume

Adjusting the volume on the computer is easy. See **"Hot keys"** on page **16** for more information on adjusting the speaker volume.

Using system utilities

Acer eManager

Acer eManager is an innovative software package designed for frequently used functions. Press the Acer Empowering Key "e" and the Acer eManager user interface appears. It has four main features: Acer eSetting, Acer ePresentation, Acer ePowerManagement and Acer eRecovery.



To locate the Acer Empowering Key "e", see "Launch keys" on page 19.



Acer eSetting

makes managing system settings and security easy.



Acer ePresentation

simplifies resolution settings when connecting to a projector.



Acer ePowerManagement

allows power-on-demand intelligence for optimized battery life.



Acer eRecovery

creates backups and recovers system configurations reliably.

Acer GridVista (dual-display compatible)

Acer GridVista is a handy utility that offers four pre-defined display settings so you can view multiple windows on the same screen. To access this function, please go to **"Start" - "All Programs"** and click on **"Acer GridVista"**. You may choose any one of the four display settings indicated below:



Double (Vertical), Triple (Major at left), Triple (Major at right), or Quad GridVista is dual-display compatible, allowing two displays to be partitioned independently.

GridVista is simple to set up:

- 1 Run GridVista and select your preferred screen configuration for each display from the taskbar.
- 2 Drag and drop each window into the appropriate grid.
- 3 Enjoy the convenience of a well-organized desktop.

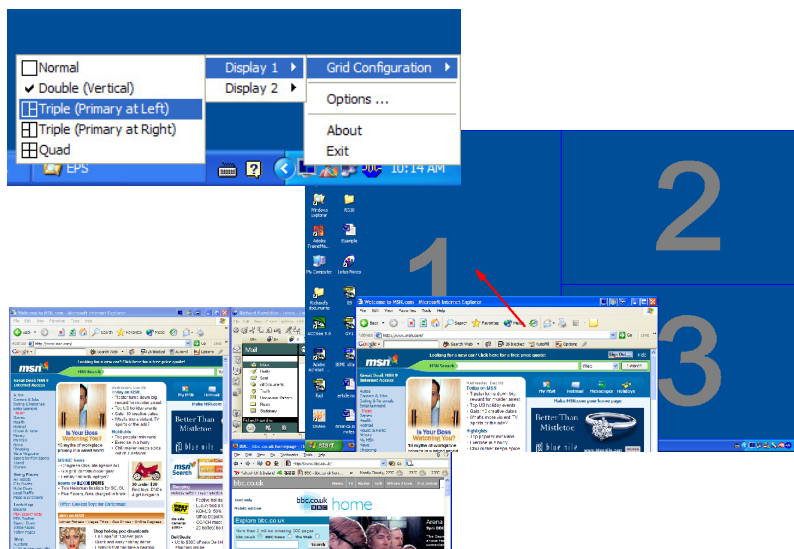

To enable the dual monitor feature of your notebook. First, ensure the secondary monitor is connected. Then, select **"Start"->"Control Panel"->"Display"** and click on **"Settings"**. Select the secondary monitor (2) icon in the display box and then click the check box **"Extend my windows desktop onto this monitor"**. Finally, **"Apply"** the new settings and then click **"OK"** to complete the process.



Note: Please ensure the resolution setting of your second monitor is set to the manufacturer's recommended value.

Launch Manager

Launch Manager allows you to set the launch key located above the keyboard. See **"Launch keys"** on page 19 for the location of the launch keys.

You can access the Launch Manager by clicking on **Start, All Programs,** and then **Launch Manager** to start the application.

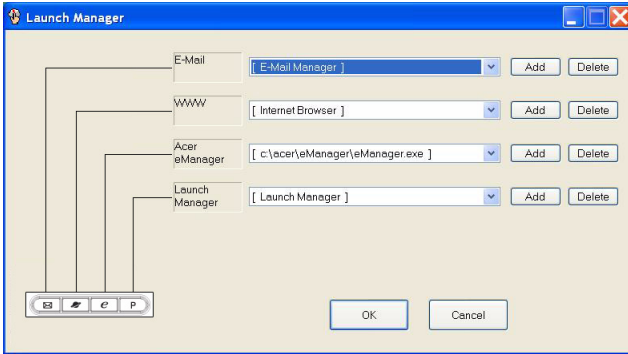

Moving around with your notebook PC

This section gives you tips and hints to consider when moving around or traveling with your computer.

Disconnecting from the desktop

Follow these steps to disconnect your computer from external accessories:

- 1 Save your work in progress.
- 2 Remove any media, floppy discs or compact discs, from the drive(s).
- 3 Shut down the computer.
- 4 Close the display cover.
- 5 Disconnect the cord from the AC adaptor.
- 6 Disconnect the keyboard, pointing device, printer, external monitor, and other external devices.
- 7 Disconnect the Kensington lock if you are using one to secure the computer.

Moving around

When you are just moving within short distances, for example, from your office desk to a meeting room.

Preparing the computer

Before moving the computer, close the display cover to place it in Sleep mode. You can now safely take the computer anywhere you go within the building. To bring the computer out of Sleep mode, open the display; then press and release the power button.

If you are taking the computer to a client's office or a different building, you may choose to shut down the computer:

Click on **Start, Turn Off Computer**; then click on **Turn Off** (Windows® XP).

- or -

you can put the computer in Sleep mode by pressing <Fn>+<F4>. Then close the display.

When you are ready to use the computer again, open the display; then press and release the power button.



Note: If the Sleep indicator is off, the computer has entered Hibernation mode and is turned off. If the power indicator is off but the Sleep indicator is on, the computer has entered Sleep mode. In both cases, press and release the power button to turn the computer back on. Note that the computer may enter Hibernation mode after being in Sleep mode for a period of time.

What to take to short meetings

A fully charged battery runs the computer for about 2.5 hours. If your meeting is shorter than that, you probably do not need to take anything with you other than the computer.

What to bring to long meetings

If your meeting lasts longer than 2.5 hours, or if your battery is not fully charged, you may want to take the AC adaptor with you to plug in your computer while in the meeting room.

If the meeting room does not have an electrical outlet, reduce the drain on the battery by putting the computer in Sleep mode. Press <Fn>+<F4> or close the display cover whenever you are not actively using the computer. To resume, open the display (if closed); then press and release the power button.

Taking the computer home

When you are moving from your office to your home or vice versa.

Preparing the computer

After disconnecting the computer from your desktop, follow these steps to prepare the computer for the trip home:

- Check if you have removed all media and compact discs from the drive(s). Failure to remove the media can damage the drive head.
- Pack the computer in a protective case that can prevent the computer from sliding around and cushion it if it should fall.



.....
Caution: Avoid packing items next to the top cover of the computer. Pressure against the top cover can damage the screen.

What to take with you

Unless you already have some items at home, take the following items with you:

- AC adaptor and power cord
- The printed User's Guide

Special considerations

Follow these guidelines to protect your computer while traveling to and from work:

- Minimise the effects of temperature changes by keeping the computer with you.
- If you need to stop for an extended period of time and cannot carry the computer with you, leave the computer in the trunk of the car to avoid exposing the computer to excessive heat.
- Changes in temperature and humidity can cause condensation. Allow the computer to return to room temperature, and inspect the screen for condensation before turning on the computer. If the temperature change is greater than 18°F (10°C), allow the computer to come to room temperature slowly. If possible, leave the computer for 30 minutes in an environment with a temperature between outside and room temperature.

Setting up a home office

If you frequently work on your computer at home, you may want to purchase a second AC adaptor for use at home. With a second AC adaptor, you can avoid carrying the extra weight to and from home.

If you use your computer at home for significant periods of time, you might also want to add an external keyboard, monitor, or mouse.

Traveling with the computer

When you are moving within a larger distance, for instance, from your office building to a client's office building or traveling locally.

Preparing the computer

Prepare the computer as if you were taking it home. Make sure that the battery in the computer is charged. Airport security may require you to turn on your computer when carrying it into the gate area.

What to take with you

Take the following items with you:

- AC adaptor
- Spare, fully-charged battery pack(s)
- Additional printer driver files if you plan to use another printer

Special considerations

In addition to the guidelines for taking the computer home, follow these guidelines to protect your computer while traveling:

- Always take the computer as carry-on luggage.
- If possible, have the computer inspected by hand. Airport security X-ray machines are safe, but do not put the computer through a metal detector.
- Avoid exposing floppy discs to hand-held metal detectors.

Traveling internationally with the computer

When you are moving from country to country.

Preparing the computer

Prepare the computer as you would normally prepare it for traveling.

What to bring with you

Bring the following items with you:

- AC adaptor
- Power cords that are appropriate for the country to which you are traveling
- Spare, fully-charged battery packs
- Additional printer driver files if you plan to use another printer
- Proof of purchase, in case you need to show it to customs officials
- International Travelers Warranty passport

Special considerations

Follow the same special considerations as when traveling with the computer. In addition, these tips are useful when traveling internationally:

- When traveling in another country, check that the local AC voltage and the AC adaptor power cord specifications are compatible. If not, purchase a power cord that is compatible with the local AC voltage. Do not use converter kits sold for appliances to power the computer.
- If you are using the modem, check if the modem and connector is compatible with the telecommunications system of the country you are traveling in.

Securing your computer

Your computer is a valuable investment that you need to take care of. Learn how to protect and take care of your computer.

Security features include hardware and software locks — a security notch and passwords.

Using a computer security lock

A security keylock notch, located on the right hand side of the computer, lets you connect a Kensington-compatible computer security lock.

Wrap a computer security lock cable around an immovable object such as a table or handle of a locked drawer. Insert the lock into the notch and turn the key to secure the lock. Some keyless models are also available.

Using passwords

Passwords protect your computer from unauthorized access. Setting these passwords creates several different levels of protection for your computer and data:

- Supervisor Password prevents unauthorized entry into the BIOS utility. Once set, you must enter this password to gain access to the BIOS utility. **See “BIOS utility” on page 39.**
- User Password secures your computer against unauthorized use. Combine the use of this password with password checkpoints on boot-up and resume from hibernation for maximum security.
- Password on Boot secures your computer against unauthorized use. Combine the use of this password with password checkpoints on boot-up and resume from hibernation for maximum security.



Important! Do not forget your Supervisor Password! If you forget your password, please get in touch with your dealer or an authorized service center.

Entering passwords

When a password is set, a password prompt appears in the center of the display screen.

- When the Supervisor Password is set, a prompt appears when you press <F2> to enter the BIOS utility at boot-up.
- Type the Supervisor Password and press <Enter> to access the BIOS utility. If you enter the password incorrectly, a warning message appears. Try again and press <Enter>.
- When the User Password is set and the password on boot parameter is enabled, a prompt appears at boot-up.
- Type the User Password and press <Enter> to use the computer. If you enter the password incorrectly, a warning message appears. Try again and press <Enter>.



Important! You have three chances to enter a password. If you fail to enter the password correctly after three tries, the system halts. Press and hold the power button for four seconds to shut down the computer. Then turn on the computer again, and try again.

Setting passwords

You can set passwords using the BIOS utility.

Expanding through options

Your notebook PC offers you a complete mobile computing experience.

Connectivity options

Ports allow you to connect peripheral devices to your computer as you would with a desktop PC. For instructions on how to connect different external devices to the computer, read the following section for more details.

Fax/Data modem

Your computer has a built-in V.92 56Kbps fax/data modem.



.....
Warning! This modem port is not compatible with digital phone lines. Plugging this modem into a digital phone line will damage the modem.

To use the fax/data modem port, connect a phone cable from the modem port to a telephone jack.

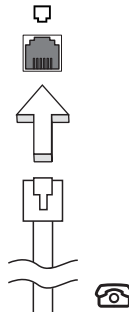

.....
Warning: Please make sure that the cable you use is appropriate for the country in which you are working.

Built-in network feature

The built-in network feature allows you to connect your computer to an Ethernet-based network.

To use the network feature, connect an Ethernet cable from the network jack on the left hand side of the computer to a network jack or hub on your network.

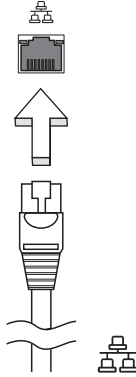

Fast Infrared

The computer's Fast Infrared (FIR) port allows you to do wireless data transfer with other IR-aware computers and peripherals such as PDAs, mobile phones, and infrared printers. The infrared port can transfer data at speeds of up to 4 Mbps at a distance of up to one metre.

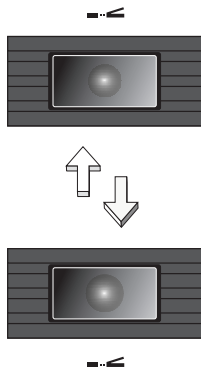

Universal Serial Bus

The USB 2.0 port is a high-speed serial bus which allows you to connect USB peripherals without taking up precious system resources.

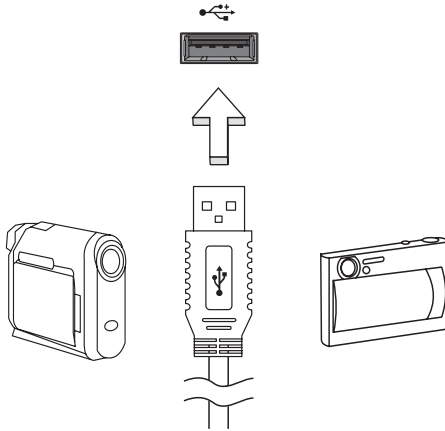

IEEE 1394 port

The computer's IEEE 1394 port allows you to connect to an IEEE 1394 supported devices like a DVD/CD-RW combo or DVD-Dual drive.

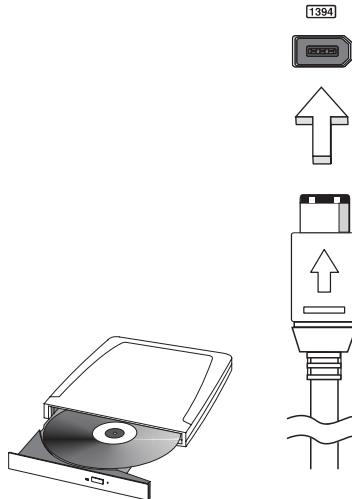

PC Card slot

The Type II PC Card slot of the computer accepts PC Cards that enhance the usability and expandability of the computer. These cards should have a PC Card logo on them.

PC Cards (formerly PCMCIA) are add-on cards for portable computers, giving you expansion possibilities long afforded by desktop PCs. Popular PC Cards include flash, fax/data modem, LAN, wireless LAN and SCSI cards. CardBus improves on the 16-bit PC card technology by expanding the bandwidth to 32 bits.



.....
Note: Refer to your card's manual for details on how to install and use the card, and its functions.

Inserting a PC Card

Insert the card into the slot and make the proper connections (e.g., network cable), if necessary. See your card manual for details.

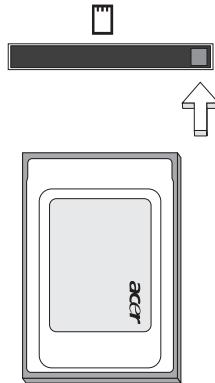

Ejecting a PC Card

Before ejecting a PC Card:

- 1 Exit the application using the card.
- 2 Left-click on the PC Card icon on the taskbar and stop the card operation.
- 3 Press the slot eject button to pop out the eject button; then press it again to eject the card.

Installing memory

Follow these steps to install memory:

- 1 Turn off the computer, unplug the AC adaptor (if connected) and remove the battery pack. Then turn the computer over to access its base.
- 2 Remove the screws from the memory cover; then lift up and remove the memory cover.
- 3 (a) Insert the memory module diagonally into the slot, then (b) gently press it down until it clicks into place.

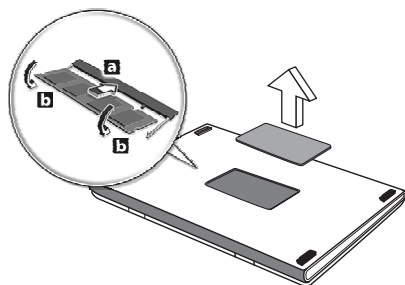

- 4 Replace the memory cover and secure it with the screw.
- 5 Reinstall the battery pack, and reconnect the AC adaptor.
- 6 Turn on the computer.

The computer automatically detects and reconfigures the total memory size. Please consult a qualified technician or contact your local Acer dealer.

BIOS utility

The BIOS utility is a hardware configuration program built into your computer's BIOS.

Your computer is already properly configured and optimized, and you do not need to run this utility. However, if you encounter configuration problems, you may need to run it.

To activate the BIOS utility, press **<F2>** during the POST; while the notebook PC logo is being displayed.

Boot sequence

To set the boot sequence in the BIOS utility, activate the BIOS utility, then select "**Boot**" from the categories listed at the top of the screen.

Disc to disc recovery enable

To enable disc to disc recovery (hard disc recovery), activate the BIOS utility, then select "**Main**" from the categories listed at the top of the screen. Find "**D2D Recovery**" at the bottom of the screen and use the F5/F6 keys to set this value to "**Enabled**".

Password

To set a password on boot, activate the BIOS utility, then select "**Security**" from the categories listed at the top of the screen. Find "**Password on boot:**" and use the F5/F6 keys to enable this feature.

Using software

Playing DVD movies

When the DVD drive module is installed in the optical drive bay, you can play DVD movies on your computer.

- 1 Eject the DVD tray and insert a DVD movie disc; then close the DVD tray.



Important! When you launch the DVD player for the first time, the program asks you to enter the region code. DVD discs are divided into 6 regions. Once your DVD drive is set to a region code, it will play DVD discs of that region only. You can set the region code a maximum of five times (including the first time), after which the last region code set will remain permanent. Recovering your hard disc does not reset the number of times the region code has been set. Refer to the table below for DVD movie region code information.

- 2 The DVD movie will automatically play after a few seconds.

Region code	Country or region
1	U.S.A., Canada
2	Europe, Middle East, South Africa, Japan
3	Southeast Asia, Taiwan, Korea (South)
4	Latin America, Australia, New Zealand
5	Former U.S.S.R., parts of Africa, India
6	People's Republic of China



Note: To change the region code, insert a DVD movie of a different region into the DVD drive. Please refer to the online help for more information.

Power management

This computer has a built-in power management unit that monitors system activity. System activity refers to any activity involving one or more of the following devices: keyboard, mouse, floppy drive, hard disc, peripherals connected to the serial and parallel ports, and video memory. If no activity is detected for a period of time (called an inactivity timeout), the computer stops some or all of these devices in order to conserve energy.

This computer employs a power management scheme that supports the advanced configuration and power interface (ACPI), which allows for maximum power conservation and maximum performance at the same time. Windows handles all power-saving chores for your computer.

Acer eRecovery

Acer eRecovery is a tool to quickly backup and restore the system. Users can create and save a backup of the current system configuration to hard drive, CD, or DVD.

Acer eRecovery consists of the following functions:

- 1 Create backup
- 2 Restore from backup
- 3 Create factory default image CD
- 4 Re-install bundled software without CD
- 5 Change Acer eRecovery password

This chapter will guide you through each process.



Note: This feature is only available on certain models. For systems that do not have a built-in optical disc burner, plug in an external USB or IEEE 1394-compatible optical disc burner before entering Acer eRecovery for optical disc related tasks.

Create backup

Users can create and save backup images to hard drive, CD, or DVD.

- 1 Boot to Windows® XP
- 2 Press <Alt>+<F10> to open the Acer eRecovery utility.
- 3 Enter the password to proceed. The default password is six zeros.
- 4 In the Acer eRecovery window, select **Recovery settings** and click **Next**.
- 5 In the Recovery settings window, select **Backup snapshot image** and click **Next**.
- 6 Select the backup method.
 - a Use **Backup to HDD** to store the backup disc image on drive D:.
 - b **Backup to optical device** to store the backup disc image on CD or DVD.
- 7 After choosing the backup method, click **Next**.

Follow the instruction on screen to complete the process.

Restore from backup

Users can restore backup previously created (as stated in the **Create backup** section) from hard drive, CD, or DVD.

- 1 Boot to Windows® XP.
- 2 Press <Alt>+<F10> to open the Acer eRecovery utility.
- 3 Enter the password to proceed. The default password is six zeros.
- 4 In the Acer eRecovery window, select **Recovery actions** and click **Next**.
- 5 Select the desired restore action and follow the onscreen instructions to complete the restore process.



.....

Note: The "Restore C:" item is enabled only if there is a user backup stored on the hard drive (D:\). Please refer to the **Create backup** section.

Create factory default image CD

When the System CD and Recovery CD are not available, you can create them by using this feature.

- 1 Boot to Windows® XP.
- 2 Press <Alt>+<F10> to open the Acer eRecovery utility.
- 3 Enter the password to proceed. The default password is six zeros.
- 4 In the Acer eRecovery window, select **Recovery settings** and click **Next**.
- 5 In the Recovery settings window, select **Burn image to disc** and click **Next**.
- 6 In the Burn image to disc window, select **01. Factory default image** and click **Next**.
- 7 Follow the instructions on screen to complete the process.

Re-install bundled software without CD

Acer eRecovery stores pre-loaded software internally for easy driver and application re-installation.

- 1 Boot to Windows® XP.
- 2 Press <Alt>+<F10> to open the Acer eRecovery utility.
- 3 Enter the password to proceed. The default password is six zeros.
- 4 In the Acer eRecovery window, select **Recovery actions** and click **Next**.
- 5 In the Recovery settings window, select **Reinstall applications/drivers** and click **Next**.
- 6 Select the desired driver/application and follow the instructions on screen to re-install.

At first launch, Acer eRecovery prepares all the needed software and may take few seconds to bring up the software content window.

Change password

Acer eRecovery and Acer disc-to-disc recovery are protected by a password that can be changed by the user. Follow the steps below to change the password in Acer eRecovery.

- 1 Boot to Windows® XP.
- 2 Press <Alt>+<F10> to open the Acer eRecovery utility.
- 3 Enter the password to proceed. The default password is six zeros.
- 4 In the Acer eRecovery window, select **Recovery settings** and click **Next**.
- 5 In the Recovery settings window, select **Password: Change Acer eRecovery password** and click **Next**.
- 6 Follow the instructions on screen to complete the process.



Note: If the system crashes, and will not boot to Windows, you can run Acer disc-to-disc recovery to restore the factory default image under DOS mode.

Acer disc-to-disc recovery

Multilingual operating system installation

Follow the instructions to choose the operating system and language you prefer when you first power-on the system.

- 1 Turn on the system.
- 2 Acer's multilingual operating system selection menu will pop-up automatically.
- 3 Use the arrow keys to scroll to the language version you want. Press <Enter> to confirm your selection.
- 4 The operating system and language you choose now will be the only option for future recovery operations.
- 5 The system will install the operating system and language you choose.

Restore without a Recovery CD

This recovery process helps you restore the C: drive with the original software content that is installed when you purchase your notebook. Follow the steps below to rebuild your C: drive. (Your C: drive will be reformatted and all data will be erased.) It is important to back up all data files before you use this option.

Before performing a restore operation, please check the BIOS settings.

- 1 Check to see if **Acer disc-to-disc recovery** is enabled or not.
- 2 Make sure the **[D2D Recovery]** setting in **[Main]** is **[Enabled]**.
- 3 Exit the BIOS setup utility and save changes. The system will reboot.



.....
Note: To activate BIOS setup utility, press <F2> during POST.

- 1 Restart the system.
- 2 While the Acer logo is showing, press <Alt>+<F10> at the same time to enter the recovery process.
- 3 The message "The system has password protection. Please enter 000000:" is displayed.
- 4 Enter six zeros and continue.
- 5 The Acer Recovery main page appears.
- 6 Use the arrow keys to scroll through the items (operating system versions) and press <Enter> to select.



.....
Important: This feature occupies 2 - 3 GB in a hidden partition on your hard drive.

Troubleshooting

This chapter shows you how to deal with common system problems. Read it before calling a technician if a problem occurs. Solutions to more serious problems require opening up the computer. Do not attempt to open the computer by yourself. Contact your dealer or an authorized service center for assistance.

Frequently-asked questions

The following is a list of possible situations that may arise during the use of your computer. Easy answers and solutions are provided for each one.

I pressed the power button and opened the display, but the computer does not start or boot-up.

Look at the power indicator:

- If it is not lit, no power is being supplied to the computer. Check the following:
 - If you are running on battery power, it may be low and unable to power the computer. Connect the AC adaptor to recharge the battery pack.
 - Make sure that the AC adaptor is properly plugged into the computer and to the power outlet.
- If it is lit, check the following:
 - Is a non-bootable (non-system) disc in the external USB floppy drive? Remove or replace it with a system disc and press **<Ctrl>+<Alt>+** to restart the system.

Nothing appears on the screen.

The computer's power management system automatically blanks the screen to save power. Press any key to turn the display back on.

If pressing a key does not turn the display back on, three things might be the cause:

- The brightness level might be too low. Press <Fn>+<-> (increase) to adjust the brightness level.
- The display device might be set to an external monitor. Press the display toggle hot key <Fn>+<F5> to toggle the display back to the computer.
- If the Sleep indicator is lit, the computer is in Sleep mode. Press and release the power button to resume.

Image is not full-screen.

Make sure the resolution is set to 1280 x 800 / 1280 x 768. This is the native resolution of your display. If you set the resolution lower than this, the screen expands to fill the computer display. Right-click on your Windows desktop and select Properties to bring up the **Display Properties** dialog box. Then click on the Settings tab to make sure that the resolution is set to the appropriate resolution. Resolutions lower than the specified resolution are not full-screen on the computer or on an external monitor.

No audio is heard from the computer.

Check the following:

- The volume may be muted. In Windows, look at the volume control (speaker) icon on the taskbar. If it is crossed-out, click on the icon and deselect the Mute option.
- The volume level may be too low. In Windows, look at the volume control icon on the taskbar. You can also use the volume control buttons to adjust the volume. See "**Hot keys**" on page 16 for more detail.
- If headphones, earphones or external speakers are connected to the line-out port on the computer, the internal speakers automatically turn off.

I want to eject the optical drive tray without turning on the power. I cannot eject the optical drive tray.

There is a mechanical eject button on the optical drive. Simply insert the tip of a pen or paperclip and push to eject the tray.

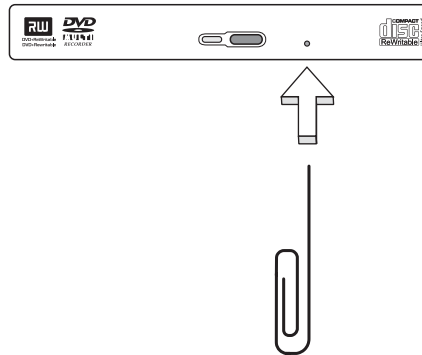

The keyboard does not respond.

Try attaching an external keyboard to a USB 2.0 port on the computer. If it works, contact your dealer or an authorized service center as the internal keyboard cable may be loose.

The infrared port does not work.

Check the following:

- Make sure that the infrared ports of the two devices are facing each other (+/- 15 degrees) a maximum of 1 metre apart.
- Make sure there is a clear path between the two infrared ports. Nothing should be blocking the ports.
- Make sure you have the appropriate software running on both devices (for file transfers) or you have the appropriate drivers (for printing to an infrared printer).
- During the POST, press <F2> to access the BIOS utility and verify that the infrared port is enabled.
- Make sure both devices are IrDA-compliant.

The printer does not work.

Check the following:

- Make sure that the printer is connected to a power outlet and that it is turned on.
- Make sure that the printer cable is connected securely to the computer's parallel port or a USB port and the corresponding port on the printer.

I want to set up my location to use the internal modem.

To properly use your communication software (e.g. HyperTerminal), you need to set up your location:

- 1 Click on **Start, Settings, Control Panel**.
- 2 Double-click on **Modems**.
- 3 Click on **Dialing Properties** and begin setting up your location.

Refer to the Windows manual.



.....

Note: Please note, on first booting your notebook, that you can skip the Internet Connection setup, as it is not necessary to affect the installation of your overall Operating System. After the Operating System is setup, you can proceed with the Internet Connection setup.

Troubleshooting tips

This notebook computer incorporates an advanced design that delivers onscreen error message reports to help you solve problems.

If the system reports an error message or an error symptom occurs, see "**Error messages**" below. If the problem cannot be resolved, contact your dealer. See "**Requesting service**" on page 52.

Error messages

If you receive an error message, note the message and take the corrective action. The following table lists the error messages in alphabetical order together with the recommended course of action.

Error messages	Corrective action
CMOS battery bad	Contact your dealer or an authorized service center.
CMOS checksum error	Contact your dealer or an authorized service center.
Disc boot failure	Insert a system (bootable) disc into the floppy drive (A:), then press <Enter> to reboot.
Equipment configuration error	Press <F2> (during POST) to enter the BIOS utility; then press Exit in the BIOS utility to reboot.
Hard disc 0 error	Contact your dealer or an authorized service center.
Hard disc 0 extended type error	Contact your dealer or an authorized service center.
I/O parity error	Contact your dealer or an authorized service center.
Keyboard error or no keyboard connected	Contact your dealer or an authorized service center.
Keyboard interface error	Contact your dealer or an authorized service center.
Memory size mismatch	Press <F2> (during POST) to enter the BIOS utility; then press Exit in the BIOS utility to reboot.

If you still encounter problems after going through the corrective measures, please contact your dealer or an authorized service center for assistance. Some problems may be solved using the BIOS utility.

Requesting service

International Travelers Warranty (ITW)

Your computer is backed by an International Travelers Warranty (ITW) that gives you security and peace of mind when traveling. Our worldwide network of service centers are there to give you a helping hand.

An ITW passport comes with your computer. This passport contains all you need to know about the ITW program. A list of available, authorized service centers is in this handy booklet. Read this passport thoroughly.

Always have your ITW passport on hand, especially when you travel, to receive the benefits from our support centers. Place your proof-of-purchase in the flap located inside the front cover of the ITW passport.

If the country you are traveling in does not have an Acer-authorized ITW service site, you can still get in contact with our offices worldwide. Please consult <http://global.acer.com>.

Before you call

Please have the following information available when you call Acer for online service, and please be at your computer when you call. With your support, we can reduce the amount of time a call takes and help solve your problems efficiently.

If there are error messages or beeps reported by your computer, write them down as they appear on the screen (or the number and sequence in the case of beeps).

You are required to provide the following information:

Name: _____

Address: _____

Telephone number: _____

Machine and model type: _____

Serial number: _____

Date of purchase: _____

Regulations and safety notices

Energy Star Guidelines Compliance

As an Energy Star partner, Acer Inc. has determined that this product meets the Energy Star guidelines for energy efficiency.

FCC notice

This device has been tested and found to comply with the limits for a Class B digital device pursuant to Part 15 of the FCC rules. These limits are designed to provide reasonable protection against harmful interference in a residential installation. This device generates, uses, and can radiate radio frequency energy and, if not installed and used in accordance with the instructions, may cause harmful interference to radio communications.

However, there is no guarantee that interference will not occur in a particular installation. If this device does cause harmful interference to radio or television reception, which can be determined by turning the device off and on, the user is encouraged to try to correct the interference by one or more of the following measures:

- Reorient or relocate the receiving antenna.
- Increase the separation between the device and receiver.
- Connect the device into an outlet on a circuit different from that to which the receiver is connected.
- Consult the dealer or an experienced radio/television technician for help.

Notice: Shielded cables

All connections to other computing devices must be made using shielded cables to maintain compliance with FCC regulations.

Notice: Peripheral devices

Only peripherals (input/output devices, terminals, printers, etc.) certified to comply with the Class B limits may be attached to this equipment. Operation with non-certified peripherals is likely to result in interference to radio and TV reception.

Caution

Changes or modifications not expressly approved by the manufacturer could void the user's authority, which is granted by the Federal Communications Commission, to operate this computer.

Operation conditions

This device complies with Part 15 of the FCC Rules. Operation is subject to the following two conditions: (1) this device may not cause harmful interference, and (2) this device must accept any interference received, including interference that may cause undesired operation.

Notice: Canadian users

This Class B digital apparatus complies with Canadian ICES-003.

Remarque à l'intention des utilisateurs canadiens

Cet appareil numérique de la classe B est conforme à la norme NMB-003 du Canada.

Declaration of Conformity for EU countries

Hereby, Acer, declares that this notebook PC series is in compliance with the essential requirements and other relevant provisions of Directive 1999/5/EC. (Please visit <http://global.acer.com/products/notebook/reg-nb/index.htm> for complete documents.)

Compliant with Russian regulatory certification



ME61

Modem notices

Notice for USA

This equipment complies with Part 68 of the FCC rules. Located on the modem is a label that contains, among other information, the FCC Registration Number and Ringer Equivalence Number (REN) for this equipment. Upon request, you must provide this information to your telephone company.

If your telephone equipment causes harm to the telephone network, the telephone company may discontinue your service temporarily. If possible, they will notify you in advance. But, if advance notice is not practical, you will be notified as soon as possible. You will also be informed of your right to file a complaint with the FCC.

Your telephone company may make changes in its facilities, equipment, operations, or procedures that could affect the proper functioning of your equipment. If they do, you will be notified in advance to give you an opportunity to maintain uninterrupted telephone service.

If this equipment should fail to operate properly, disconnect the equipment from the phone line to determine if it is causing the problem. If the problem is with the equipment, discontinue use and contact your dealer or vendor.



.....
Caution: To reduce the risk of fire, use only No. 26 AWG or larger UL Listed or CSA Certified Telecommunication Line Cord.

TBR 21

This equipment has been approved [Council Decision 98/482/EC - "TBR 21"] for single terminal connection to the Public Switched Telephone Network (PSTN). However, due to differences between the individual PSTNs provided in different countries, the approval does not, of itself, give an unconditional assurance of successful operation on every PSTN termination point. In the event of problems, you should contact your equipment supplier in the first instance.

List of Applicable Countries

EU member states as of May 2004 are: Belgium, Denmark, Germany, Greece, Spain, France, Ireland, Italy, Luxembourg, the Netherlands, Austria, Portugal, Finland, Sweden, United Kingdom Estonia, Latvia, Lithuania, Poland, Hungary, Czech Republic, Slovak Republic, Slovenia, Cyprus and Malta. Usage allowed in the countries of European Union, as well as Norway, Switzerland, Iceland and Liechtenstein. This device must be used in strict accordance with the regulations and constraints in the country of use. For further information, please contact local office in the country of use.

Notice for Australia

For safety reasons, only connect headsets with a telecommunications compliance label. This includes customer equipment previously labelled permitted or certified.

Notice for New Zealand

For modem with approval number PTC 211/03/008

- 1 The grant of a Telepermit for any item of terminal equipment indicates only that Telecom has accepted that the item complies with minimum conditions for connection to its network. It indicates no endorsement of the product by Telecom, nor does it provide any sort of warranty. Above all, it provides no assurance that any item will work correctly in all respects with another item of Telepermitted equipment of a different make or model, nor does it imply that any product is compatible with all of Telecom's network services.
- 2 This equipment is not capable, under all operating conditions, of correct operation at the higher speeds for which it is designed. Telecom will accept no responsibility should difficulties arise in such circumstances.
- 3 Some parameters required for compliance with Telecom's Telepermit requirements are dependent on the equipment (PC) associated with this device. The associated equipment shall be set to operate within the following limits for compliance with Telecom's Specifications:
 - a There shall be no more than 10 call attempts to the same number within any 30 minute period for any single manual call initiation, and

- b The equipment shall go on-hook for a period of not less than 30 seconds between the end of one attempt and the beginning of the next call attempt.
- 4 Some parameters required for compliance with Telecom's Telepermit requirements are dependent on the equipment (PC) associated with this device. In order to operate within the limits for compliance with Telecom's specifications, the associated equipment shall be set to ensure that automatic calls to different numbers are spaced such that there is not less than 5 seconds between the end of one call attempt and the beginning of another.
- 5 This equipment shall not be set up to make automatic calls to Telecom's 111 Emergency Service.

For modem with approval number PTC 211/01/030

- 1 The grant of a Telepermit for any item of terminal equipment indicates only that Telecom has accepted that the item complies with minimum conditions for connection to its network. It indicates no endorsement of the product by Telecom, nor does it provide any sort of warranty. Above all, it provides no assurance that any item will work correctly in all respects with another item of Telepermitted equipment of a different make or model, nor does it imply that any product is compatible with all of Telecom's network services.
- 2 This equipment is not capable, under all operating conditions, of correct operation at the higher speeds for which it is designed. Telecom will accept no responsibility should difficulties arise in such circumstances.
- 3 This device is equipped with pulse dialing while the Telecom standard is DTMF tone dialing. There is no guarantee that Telecom lines will always continue to support pulse dialing.
- 4 Use of pulse dialing, when this equipment is connected to the same line as other equipment, may give rise to bell tinkle or noise and may also cause a false answer condition. Should such problems occur, the user should NOT contact the telecom Fault Service.
- 5 This equipment may not provide for the effective hand-over of a call to another device connected to the same line.
- 6 Under power failure conditions this appliance may not operate. Please ensure that a separate telephone, not dependent on local power, is available for emergency use.

- 7 Some parameters required for compliance with Telecom's Telepermit requirements are dependent on the equipment (PC) associated with this device. The associated equipment shall be set to operate within the following limits for compliance with Telecom's specifications, the associated equipment shall be set to ensure that calls are answered between 3 and 30 seconds of receipt of ringing.
- 8 This equipment shall not be set up to make automatic calls to Telecom's 111 Emergency Service.

Important safety instructions

Read these instructions carefully. Save them for future reference.

- 1 Follow all warnings and instructions marked on the product.
- 2 Unplug this product from the wall outlet before cleaning. Do not use liquid cleaners or aerosol cleaners. Use a damp cloth for cleaning.
- 3 Do not use this product near water.
- 4 Do not place this product on an unstable cart, stand, or table. The product may fall, causing serious damage to the product.
- 5 Slots and openings are provided for ventilation; to ensure reliable operation of the product and to protect it from overheating. These openings must not be blocked or covered. The openings should never be blocked by placing the product on a bed, sofa, rug, or other similar surface. This product should never be placed near or over a radiator or heat register, or in a built-in installation unless proper ventilation is provided.
- 6 This product should be operated from the type of power indicated on the marking label. If you are not sure of the type of power available, consult your dealer or local power company.
- 7 Do not allow anything to rest on the power cord. Do not locate this product where persons will walk on the cord.
- 8 If an extension cord is used with this product, make sure that the total ampere rating of the equipment plugged into the extension cord does not exceed the extension cord ampere rating. Also, make sure that the total rating of all products plugged into the wall outlet does not exceed the fuse rating.
- 9 Never push objects of any kind into this product through cabinet slots as they may touch dangerous voltage points or short out

- parts that could result in a fire or electric shock. Never spill liquid of any kind on the product.
- 10 Do not attempt to service this product yourself, as opening or removing covers may expose you to dangerous voltage points or other risks. Refer all servicing to qualified service personnel.
 - 11 Unplug this product from the wall outlet and refer servicing to qualified service personnel under the following conditions:
 - a When the power cord or plug is damaged or frayed.
 - b If liquid has been spilled into the product.
 - c If the product has been exposed to rain or water.
 - d If the product does not operate normally when the operating instructions are followed. Adjust only those controls that are covered by the operating instructions since improper adjustment of other controls may result in damage and will often require extensive work by a qualified technician to restore the product to normal condition.
 - e If the product has been dropped or the case has been damaged.
 - f If the product exhibits a distinct change in performance, indicating a need for service.
 - 12 The notebook PC series uses lithium batteries. Replace the battery with the same type as the product's battery we recommend in the product specification list. Use of another battery may present a risk of fire or explosion.
 - 13 **Warning!** Batteries may explode if not handled properly. Do not disassemble or dispose of them in fire. Keep them away from children and dispose of used batteries promptly.
 - 14 To avoid hazard of unexpected electrical shock, use the AC adaptor only when the wall socket is properly grounded.
 - 15 Use only the proper type of power supply cord set (provided in your accessories box) for this unit. It should be a detachable type: UL listed/CSA certified, type SPT-2, rated 7 A 125 V minimum, VDE approved or its equivalent. Maximum length is 15 feet (4.6 metres).
 - 16 Always disconnect all telephone lines from the wall outlet before serving or disassembling this equipment.
 - 17 Avoid using a telephone (other than a cordless type) during an electrical storm. There may be a remote risk of electric shock from lightning.

Laser compliance statement

The CD or DVD drive used with this computer is a laser product. The CD or DVD drive's classification label (shown below) is located on the drive.

CLASS 1 LASER PRODUCT

CAUTION: INVISIBLE LASER RADIATION WHEN OPEN. AVOID EXPOSURE TO BEAM.

APPAREIL A LASER DE CLASSE 1 PRODUIT

LASERATTENTION: RADIATION DU FAISCEAU LASER INVISIBLE EN CAS D'OUVERTURE. EVITER TOUTE EXPOSITION AUX RAYONS.

LUOKAN 1 LASERLAITE LASER KLASSE 1

VORSICHT: UNSICHTBARE LASERSTRAHLUNG, WENN ABDECKUNG GEÖFFNET NICHT DEM STRAHLL AUSSETZEN

PRODUCTO LÁSER DE LA CLASE I

ADVERTENCIA: RADIACIÓN LÁSER INVISIBLE AL SER ABIERTO. EVITE EXPONERSE A LOS RAYOS.

ADVARSEL: LASERSTRÅLING VEDÅBNING SE IKKE IND I STRÅLEN.

VARO! LAVATTAESSA OLET ALTTINA LASERSÄTEILYLLE.

VARNING: LASERSTRÅLNING NÅR DENNA DEL ÅR ÖPPNAD ÅLÅ TUIJOTA SÄTEESEENSTIRRA EJ IN I STRÅLEN

VARNING: LASERSTRÅLNING NAR DENNA DEL ÅR ÖPPNADSTIRRA EJ IN I STRÅLEN

ADVARSEL: LASERSTRÅLING NAR DEKSEL ÅPNESSTIRR IKKE INN I STRÅLEN

LCD pixel statement

The LCD unit is produced with high-precision manufacturing techniques. Nevertheless, some pixels may occasionally misfire or appear as black or red dots. This has no effect on the recorded image and does not constitute a malfunction.

Macrovision copyright protection notice

This product incorporates copyright protection technology that is protected by U.S. patents and other intellectual property rights. Use of this copyright protection technology must be authorized by Macrovision, and is intended for home and other limited viewing uses only unless otherwise authorized by Macrovision. Reverse engineering or disassembly is prohibited.

U.S. Patent Nos. 4,631,603; 4,819,098; 4,907,093; 5,315,448; and 6,516,132.

Radio Device Regulatory Notice



.....
Note: Below regulatory information is for models with wireless LAN and/or Bluetooth® only.

General

This product complies with the radio frequency and safety standards of any country or region in which it has been approved for wireless use. Depending on configurations, this product may or may not contain wireless radio devices (such as wireless LAN and/or Bluetooth® modules). Below information is for products with such devices.

European Union (EU)

This device complies with the essential requirements of the European Council Directives listed below:

73/23/EEC Low Voltage Directive

- EN 60950

89/336/EEC Electromagnetic Compatibility (EMC) Directive

- EN 55022
- EN 55024
- EN 61000-3-2/-3

99/5/EC Radio & Telecommunications Terminal Equipment (R&TTE) Directive

- Art.3.1a) EN 60950
- Art.3.1b) EN 301 489 -1/-17
- Art.3.2) EN 300 328-2
- Art.3.2) EN 301 893 *applies to 5 GHz only

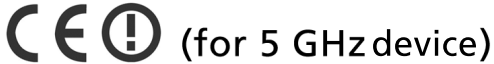

List of Applicable Countries

EU member states as of May 2004 are: Belgium, Denmark, Germany, Greece, Spain, France, Ireland, Italy, Luxembourg, the Netherlands, Austria, Portugal, Finland, Sweden, United Kingdom Estonia, Latvia, Lithuania, Poland, Hungary, Czech Republic, Slovak Republic, Slovenia, Cyprus and Malta. Usage allowed in the countries of European Union, as well as Norway, Switzerland, Iceland and Liechtenstein. This device must be used in strict accordance with the regulations and constraints in the country of use. For further information, please contact local office in the country of use.

The FCC RF safety requirement

The radiated output power of Wireless LAN Mini-PCI Card and Bluetooth® card is far below the FCC radio frequency exposure limits. Nevertheless, the notebook PC series shall be used in such a manner that the potential for human contact during normal operation is minimized as follows:

- 1 Users are requested to follow the RF safety instructions on wireless option devices that are included in the user's manual of each RF option device.



Caution: To comply with FCC RF exposure compliance requirements, a separation distance of at least 20 cm (8 inches) must be maintained between the antenna for the integrated Wireless LAN Mini-PCI Card built in to the screen section and all persons.

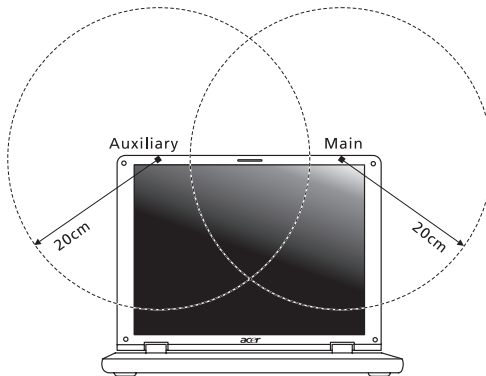

Note: Acer Wireless Mini PCI Adaptor implements a transmission diversity function. The function does not emit radio frequencies simultaneously from both antennas. One of the antennas is selected automatically or manually (by users) to ensure good-quality radiocommunication.

- 2 This device is restricted to indoor use due to its operation in the 5.15 to 5.25 GHz frequency range. FCC requires this product to be used indoors for the frequency range 5.15 to 5.25 GHz to reduce the potential for harmful interference to co-channel Mobile Satellite systems.
- 3 High power radar are allocated as primary users of the 5.25 to 5.35 GHz and 5.65 to 5.85 GHz bands. These radar stations can cause interference with and/or damage this device.
- 4 An improper installation or unauthorized use may cause harmful interference to radio communications. Also any tampering of the internal antenna will void the FCC certification and your warranty.

Canada - Low power license-exempt radio communication devices (RSS-210)

- a Common information
 - Operation is subject to the following two conditions:
 1. This device may not cause interference, and
 2. this device must accept any interference, including interference that may cause undesired operation of the device.
 - b Operation in 2.4 GHz band
 - To prevent radio interference to the licensed service, this device is intended to be operated indoors and installation outdoors is subject to licensing.
 - c Operation in 5 GHz band
- The device for the band 5150-5250 MHz is only for indoor usage to reduce potential for harmful interference to co-channel Mobile Satellite systems.
 - High power radars are allocated as primary users (meaning they have priority) of 5250-5350 MHz and 5650-5850 MHz and these radars could cause interference and/or damage to LELAN (Licence-Exempt Local Area Network) devices.

Exposure of humans to RF fields (RSS-102)

The notebook PC series employs low gain integral antennas that do not emit RF field in excess of Health Canada limits for the general population; consult Safety Code 6, obtainable from Health Canada's website at www.hc-sc.gc.ca/rpb.

Federal Communications Commission Declaration of Conformity

This device complies with Part 15 of the FCC Rules. Operation is subject to the following two conditions: (1) this device may not cause harmful interference, and (2) this device must accept any interference received, including interference that may cause undesired operation.

The following local manufacturer/importer is responsible for this declaration:

Product name:	Notebook personal computer
Model number:	ZH1
Machine type:	TravelMate 3000
SKU number:	TravelMate 300xxx ("x" = 0 - 9, a - z, or A - Z)
Name of responsible party:	Acer America Corporation
Address of responsible party:	2641 Orchard Parkway, San Jose, CA 95134, U.S.A.
Contact person:	Mr. Young Kim
Phone no.:	408-922-2909
Fax no.:	408-922-2606

Declaration of Conformity for CE Marking

Name of manufacturer: Beijing Acer Information Co., Ltd.
 Address of manufacturer: Huade Building, No.18, ChuangYe Rd., ShangDi Zone, HaiDian District Beijing PRCE marking
 Contact person: Mr. Easy Lai
 Tel: 886-2-8691-3089
 Fax: 886-2-8691-3000
 E-mail: easy_lai@acer.com.tw
 Declares that product: Notebook PC
 Trade name: Acer
 Model number: ZH1
 Machine type: TravelMate 3000
 SKU number: TravelMate 300xxx ("x" = 0 - 9, a - z, or A - Z)

Is in compliance with the essential requirements and other relevant provisions of the following EC directives.

Reference No.	Title
89/336/EEC	Electromagnetic Compatibility (EMC directive)
73/23/EEC	Low Voltage Directive (LVD)
1999/5/EC	Radio & Telecommunications Terminal Equipment Directive (R&TTE)

The product specified above was tested conforming to the applicable Rules under the most accurate measurement standards possible, and that all the necessary steps have been taken and are in force to assure that production units of the same product will continue to comply with the requirements.

Easy Lai
 Easy Lai / Director
 Qualification Center
 Product Assurance

2005/01/06
 Date

A

- AC adapter
 - caring for v
- audio 23
 - adjusting the volume 23
 - troubleshooting 48

B

- battery pack
 - caring for v
- BIOS utility 39
- brightness
 - hotkeys 17

C

- caps lock 13
 - on indicator 12
- care
 - AC adapter v
 - battery pack v
 - computer iv
- CD-ROM
 - ejecting 22
 - ejecting manually 49
 - troubleshooting 49
- cleaning
 - computer v
- computer
 - bringing to meetings 28
 - caring for iv
 - cleaning v
 - disconnecting 27
 - features 1, 8, 25
 - indicators 12
 - keyboards 13
 - moving around 27
 - on indicator 12
 - security 32
 - setting up a home office 30
 - taking home 29
 - traveling internationally 31
 - traveling on local trips 30
 - turning off iv
- connections
 - network 36

D

- display
 - troubleshooting 48

- DVD 40
- DVD movies
 - playing 40

E

- error messages 51
- Euro 18

F

- FAQ. See frequently-asked questions
- frequently-asked questions 47
- front view 3

H

- Hibernation mode
 - hotkey 16
- hotkeys 16

I

- indicator lights 12
- infrared 36

K

- keyboard 13
 - embedded numeric keypad 14
 - hotkeys 16
 - lock keys 13
 - troubleshooting 49
 - Windows keys 15

L

- LEDs 12
- left view 3

M

- memory
 - installing 39
- messages
 - error 51
- modem 35

N

- network 36
- num lock 13
 - on indicator 12
- numeric keypad
 - num lock 14

P

- password 32

- types 32
- PC Card 38
 - ejecting 38
 - inserting 38
- ports 35
- printer
 - troubleshooting 50
- problems 47
 - CD-ROM 49
 - display 48
 - keyboard 49
 - printer 50
 - startup 47

Q

- questions
 - setting location for modem use 50

S

- safety
 - CD or DVD 60
 - FCC notice 53
 - general instructions 58
 - modem notices 55
- scroll lock 13
- security
 - keylock 22, 32
 - passwords 32
- service
 - when to call vi

- speakers
 - hotkey 17
 - troubleshooting 48
- status indicators 12
- support
 - information 52

T

- touchpad 20
 - hotkey 17
 - using 20– 21
- travel
 - international flights 31
 - local trips 30
- troubleshooting
 - tips 50

U

- universal serial bus 37

V

- view
 - front 4
 - left 4
 - rear 6
 - right 5
- volume
 - adjusting 23

W

- Windows keys 15