

TravelMate C200 Series

User's Guide

Copyright © 2005. Acer Incorporated.
All Rights Reserved.

TravelMate C200 Series User's Guide
Original Issue: September 2005

Changes may be made periodically to the information in this publication without obligation to notify any person of such revisions or changes. Such changes will be incorporated in new editions of this manual or supplementary documents and publications. This company makes no representations or warranties, either expressed or implied, with respect to the contents hereof and specifically disclaims the implied warranties of merchantability or fitness for a particular purpose.

Record the model number, serial number, purchase date and place of purchase information in the space provided below. The serial number and model number are recorded on the label affixed to your computer. All correspondence concerning your unit should include the serial number, model number and purchase information.

No part of this publication may be reproduced, stored in a retrieval system, or transmitted, in any form or by any means, electronically, mechanically, by photocopy, recording or otherwise, without the prior written permission of Acer Incorporated.

TravelMate C200 Series Notebook PC

Model number: _____

Serial number: _____

Date of purchase: _____

Place of purchase: _____

Acer and the Acer logo are registered trademarks of Acer Incorporated. Other companies' product names or trademarks are used herein for identification purposes only and belong to their respective companies.

Disposal instructions

Do not throw this electronic device into the trash when discarding. To minimize pollution and ensure utmost protection of the global environment, please recycle.

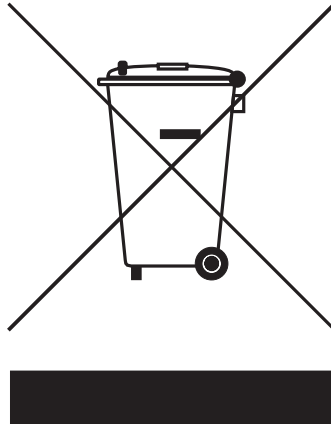

USA

For electronic products containing an LCD/CRT monitor or display:

Lamp(s) inside this product contain mercury and must be recycled or disposed of according to local, state or federal laws. For more information, contact the Electronic Industries Alliance at www.eiae.org. For lamp-specific disposal information, check www.lamprecycle.org.



First things first

We would like to thank you for making the TravelMate series of notebook PC your choice for meeting your mobile computing needs.

Your guides

To help you use your TravelMate, we have designed a set of guides:



First off, the **Just for Starters...** poster helps you get started with setting up your computer.



The printed **User's Guide** introduces you to the basic features and functions of your new computer. For more on how your computer can help you to be more productive, please refer to the **AcerSystem User's Guide**. This guide contains detailed information on such subjects as system utilities, data recovery, expansion options and troubleshooting. In addition it contains warranty information and the general regulations and safety notices for your notebook. It is available in Portable Document Format (PDF) and comes preloaded on your notebook. Follow these steps to access it:

- 1 Click on **Start, All Programs, AcerSystem**.
- 2 Click on **AcerSystem User's Guide**.

Note: Viewing the file requires Adobe Reader. If Adobe Reader is not installed on your computer, clicking on **AcerSystem User's Guide** will run the Adobe Reader setup program first. Follow the instructions on the screen to complete the installation. For instructions on how to use Adobe Reader, access the **Help and Support** menu.

Basic care and tips for using your computer

Turning your computer on and off

To turn on the computer, simply press and release the power switch on the LCD screen. See "**Top View**" on **page 9** for the location of the power button.

To turn the power off, do any of the following:

- Use the Windows shutdown command
Click on **Start, Turn Off Computer**, then click on **Turn Off**.
- Use the power button
You can also shut down the computer by closing the display cover, or by pressing the sleep hotkey **<Fn> + <F4>**.



.....

Note: If you cannot power off the computer normally, press and hold the power button for more than four seconds to shut down the computer. If you turn off the computer and want to turn it on again, wait at least two seconds before powering up.

Taking care of your computer

Your computer will serve you well if you take care of it.

- Do not expose the computer to direct sunlight. Do not place it near sources of heat, such as a radiator.
- Do not expose the computer to temperatures below 0 °C (32 °F) or above 50 °C (122 °F).
- Do not subject the computer to magnetic fields.
- Do not expose the computer to rain or moisture.
- Do not spill water or any liquid on the computer.
- Do not subject the computer to heavy shock or vibration.
- Do not expose the computer to dust or dirt.
- Never place objects on top of the computer.
- Do not slam the computer display when you close it.
- Never place the computer on uneven surfaces.

Taking care of your AC adapter

Here are some ways to take care of your AC adapter:

- Do not connect the adapter to any other device.
- Do not step on the power cord or place heavy objects on top of it. Carefully route the power cord and any cables away from foot traffic.
- When unplugging the power cord, do not pull on the cord itself but pull on the plug.
- The total ampere ratings of the equipment plugged in should not exceed the ampere rating of the cord if you are using an extension cord. Also, the total current rating of all equipment plugged into a single wall outlet should not exceed the fuse rating.

Taking care of your battery pack

Here are some ways to take care of your battery pack:

- Use only batteries of the same kind as replacements. Turn the power off before removing or replacing batteries.
- Do not tamper with batteries. Keep them away from children.
- Dispose of used batteries according to local regulations. Recycle if possible.

Cleaning and servicing

When cleaning the computer, follow these steps:

- 1 Turn off the computer and remove the battery pack.
- 2 Disconnect the AC adapter.
- 3 Use a soft, moist cloth. Do not use liquid or aerosol cleaners.

If either of the following occurs:

- the computer has been dropped or the body has been damaged;
- the computer does not operate normally

please refer to "**Frequently asked questions**" on page 33.

Caution

Changes or modifications not expressly approved by the manufacturer could void the user's authority, which is granted by the Federal Communications Commission, to operate this computer.

Operation conditions

This device complies with Part 15 of the FCC Rules. Operation is subject to the following two conditions: (1) This device may not cause harmful interference, and (2) This device must accept any interference received, including interference that may cause undesired operation.

Users are requested to follow the RF safety instructions for wireless option devices that are included in the user's manual of each RF option device.

An improper installation or unauthorized use may cause harmful interference to radio communications. Also, any tampering of the internal antenna will void the FCC certification and your warranty.

To prevent radio interference to the licensed service, this device is intended to be operated indoors, and installation outdoors is subject to licensing.

For more information about our products, services, and support information, please visit our website: <http://global.acer.com>.

Disposal instructions	iii
First things first	iv
Your guides	iv
Basic care and tips for using your computer	iv
Turning your computer on and off	iv
Taking care of your computer	v
Taking care of your AC adapter	v
Taking care of your battery pack	vi
Cleaning and servicing	vi
Acer Empowering Technology	1
Acer eDataSecurity Management	2
Acer eLock Management	3
Acer ePerformance Management	4
Acer eRecovery Management	5
Acer eSettings Management	6
Acer ePower Management	6
Acer ePresentation Management	8
A TravelMate tour	9
Top View	9
Open front view	10
Closed front view	11
Left view	12
Right view	13
Rear view	14
Base view	15
Specifications	16
Indicators	19
Easy-launch buttons	20
Trackpoint and click buttons	21
Trackpoint basics	21
Scrolling basics	21
Using the keyboard	23
Lock keys and embedded numeric keypad	23
Windows keys	24
Hotkeys	24
Special keys	26
Ejecting the optical (CD or DVD) disk	27
Using a computer security lock	27
Audio	28
Adjusting the volume	28
Using the system utilities	29
Acer Protector Suite QL fingerprint utility	29
Password choice	29
Correct scanning procedure	29
User's Fingers	30
User Enrollment	30
Launch Manager	31

Contents

Norton AntiVirus	31
Frequently asked questions	33
Requesting service	36
International Travelers Warranty (ITW)	36
Before you call	36
Using your computer in tablet mode	37
Writing in tablet mode	37
Converting to notebook mode	38
Converting to tablet mode	39
Taking your notebook PC with you	40
Disconnecting from the desktop	40
Moving around	40
Preparing the computer	40
What to bring to meetings	41
Taking the computer home	41
Preparing the computer	41
What to take with you	41
Special considerations	41
Setting up a home office	42
Traveling with the computer	42
Preparing the computer	42
What to take with you	42
Special considerations	42
Traveling internationally with the computer	43
Preparing the computer	43
What to bring with you	43
Special considerations	43
Securing your computer	43
Using a computer security lock	44
Using passwords	44
Entering passwords	45
Setting passwords	45
Expanding through options	46
Connectivity options	46
Fax/data modem	46
Built-in network feature	47
Fast Infrared (FIR)	47
Universal Serial Bus (USB)	48
IEEE 1394 port	48
PC Card slot	49
Installing memory	50
BIOS utility	51
Boot sequence	51
Enable disk-to-disk recovery	51
Password	52
Using software	52
Playing DVD movies	52

Power management	53
Acer eRecovery Management	53
Create backup	54
Restore from backup	54
Create factory default image CD	55
Re-install bundled software without CD	55
Change password	55
Troubleshooting	57
Troubleshooting tips	57
Error messages	57
Regulations and safety notices	59
ENERGY STAR guidelines compliance	59
FCC notice	59
Modem notices	60
Important safety instructions	63
Laser compliance statement	65
LCD pixel statement	65
Macrovision copyright protection notice	65
Radio device regulatory notice	66
General	66
European Union (EU)	66
The FCC RF safety requirement	67
Canada — Low-power license-exempt radio communication devices (RSS-210)	68
Federal Communications Commission	
Declaration of Conformity	69
Declaration of Conformity for CE Marking	70
Index	71

Acer Empowering Technology

Acer's innovative Empowering Technology makes it easy for you to access frequently used functions and manage your new Acer notebook. It features the following handy utilities:

- **Acer eDataSecurity Management** protects data with passwords and advanced encryption algorithms.
- **Acer eLock Management** limits access to external storage media.
- **Acer ePerformance Management** improves system performance by optimizing disk space, memory and registry settings.
- **Acer eRecovery Management** backs up/recovers data flexibly, reliably and completely.
- **Acer eSettings Management** accesses system information and adjusts settings easily.
- **Acer ePower Management** extends battery power via versatile usage profiles.
- **Acer ePresentation Management** connects to a projector and adjusts display settings conveniently.



For more information, press the <E> key to launch the Empowering Technology menu, then click on the appropriate utility and select the Help function.

Acer eDataSecurity Management

Acer eDataSecurity Management is a handy file encryption utility that protects your files from being accessed by unauthorized persons. It is conveniently integrated with Windows Explorer as a shell extension for quick and easy data encryption/decryption and also supports on-the-fly file encryption for MSN Messenger and Microsoft Outlook.

There are two passwords that can be used to encrypt/decrypt a file: the supervisor password and the file-specific password. The supervisor password is a "master" password that can decrypt any file on your system; the file-specific password is assigned when you encrypt each individual file.

The Acer eDataSecurity Management setup wizard will prompt you for a supervisor password and default file-specific password. This file-specific password will be used to encrypt files by default, or you can choose to enter your own file-specific password when encrypting a file.



Note: The password used to encrypt a file is the unique key that the system needs to decrypt it. If you lose the password, the supervisor password is the only other key capable of decrypting the file. If you lose both passwords, there will be no way to decrypt your encrypted file! **Be sure to safeguard all related passwords!**





Acer eLock Management

Acer eLock Management is a security utility that allows you to lock up your removable data, optical and floppy drives to ensure that data can't be stolen while your notebook is unattended.

- Removable data devices — includes USB disk drives, USB pen drives, USB flash drives, USB mp3 drives, USB memory card readers, IEEE 1394 disk drives and any other removable disk drives that can be mounted as a file system when plugged into the system.
- Optical drive devices — includes any kind of CD-ROM or DVD-ROM drives.
- Floppy disk drives — 3.5-inch disks only.

To activate Acer eLock Management, a password must be set first. Once set, you may apply locks to any of the three kinds of devices. Lock(s) will immediately be set without any reboot necessary, and will remain locked after rebooting, until unlocked.

If you do not set a password, Acer eLock Management will reset back to the initial status with all locks removed.



Note: If you lose your password, there is no method to reset it except by reformatting your notebook or taking your notebook to an Acer Customer Service Center. Be sure to remember or write down your password.

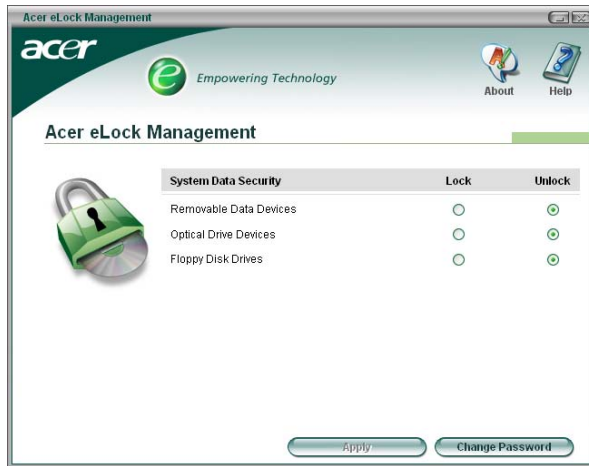

Acer ePerformance Management

Acer ePerformance Management is a system optimization tool that boosts the performance of your Acer notebook. It provides you with the following options to enhance overall system performance:

- Memory optimization — release unused memory and check usage.
- Disk optimization — remove unneeded items and files.
- Speed optimization — improve the usability and performance of your Windows XP system.



Acer eRecovery Management

Acer eRecovery Management is a powerful utility that does away with the need for recovery disks provided by the manufacturer. The Acer eRecovery Management utility occupies space in a hidden partition on your system's HDD. User-created backups are stored on D:\ drive. Acer eRecovery Management provides you with:

- Password protection.
- Recovery of applications and drivers.
- Image/data backup:
 - Backup to HDD (set recovery point).
 - Backup to CD/DVD.
- Image/data recovery tools:
 - Recover from a hidden partition (factory defaults).
 - Recover from the HDD (most recent user-defined recovery point).
 - Recover from CD/DVD.



For more information, please refer to "**Acer eRecovery Management**" on page 53 in the **AcerSystem User's Guide**.



Note: If your computer did not come with a Recovery CD or System CD, please use Acer eRecovery Management's "System backup to optical disk" feature to burn a backup image to CD or DVD. To ensure the best results when recovering your system using a CD or Acer eRecovery Management, detach all peripherals (except the external Acer ODD, if your computer has one), including your Acer ezDock.

Acer eSettings Management

Acer eSettings Management allows you to inspect hardware specifications and to monitor the system health status. Furthermore, Acer eSettings Management enables you to optimize your Windows operating system, so your computer runs faster, smoother and better.

Acer eSettings Management also:

- Provides a simple graphical user interface for navigating through the program effortlessly.
- Displays general system status and advanced monitoring for power users.
- Logs when a hardware component has been removed or replaced.
- Permits you to migrate personal settings.
- Keeps a history log of all alerts that were previously issued.



Acer ePower Management

Acer ePower Management features a straightforward user interface. To launch it, select Acer ePower Management from the Empowering Technology interface, or double-click the Acer ePower Management icon in the task tray.

AC mode

The default setting is "Maximum Performance." You can adjust CPU speed, LCD brightness and other settings, or click on buttons to turn the following functions on/off: Wireless LAN, Bluetooth, CardBus, Memory Card, Audio, and Wired LAN.

DC mode

To suit your usage, there are four pre-defined profiles — Entertainment, Presentation, Word Processing, and Maximum Battery. Or, you can define up to three of your own profiles.

Create new power scheme

- 1 Assign a name for the new scheme.
- 2 Choose existing scheme to use as a template.
- 3 Select whether used for mains (AC) or battery mode.
- 4 Choose which power options best fit your needs, then click OK.
- 5 The new profile will appear on the main screen.

Battery status

For real-time battery life estimates based on current usage, refer to the panel on the lower left-hand side of the window.

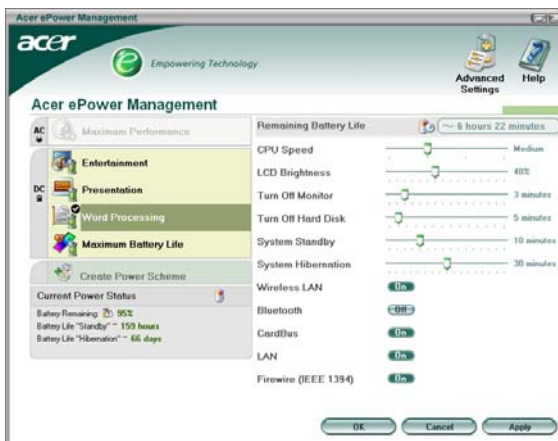

You can also click "Advanced Settings" to:

- Set alarms.
- Re-load factory defaults.
- Select what actions will be taken when the cover is closed, and set

- passwords for accessing the system after Hibernation or Standby.
- View information about Acer ePower Management.

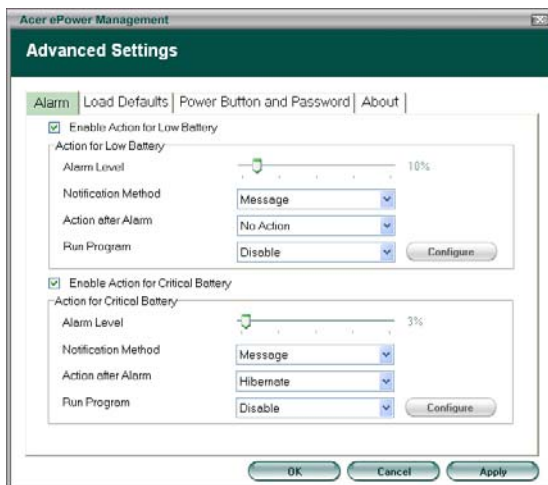

Acer ePresentation Management

Acer ePresentation Management lets you select from two of the most common projector resolutions: XGA and SVGA.



A TravelMate tour

After setting up your computer as illustrated in the **Just for Starters...** poster, let us show you around your new TravelMate computer.

Top View



#	Item	Description
1	Display screen	Also called Liquid-Crystal Display (LCD), it displays computer output.
2	Tablet-mode button	Escape button for use in tablet PC mode.
3	Tablet-mode button	Function button for use in tablet PC mode.
4	Tablet-mode button	Screen rotate button for use in tablet PC mode.
5	Biometric fingerprint reader	Provides fingerprint-verified access to operating system applications (manufacturing option). For details, refer to "Acer Protector Suite QL fingerprint utility" on page 29.

#	Item	Description
6	Windows Security lock button	A tablet-mode button, it functions like CTL-ALT-DEL to lock access to the operating system.
7	Power switch	Turns the computer on and off.

Open front view

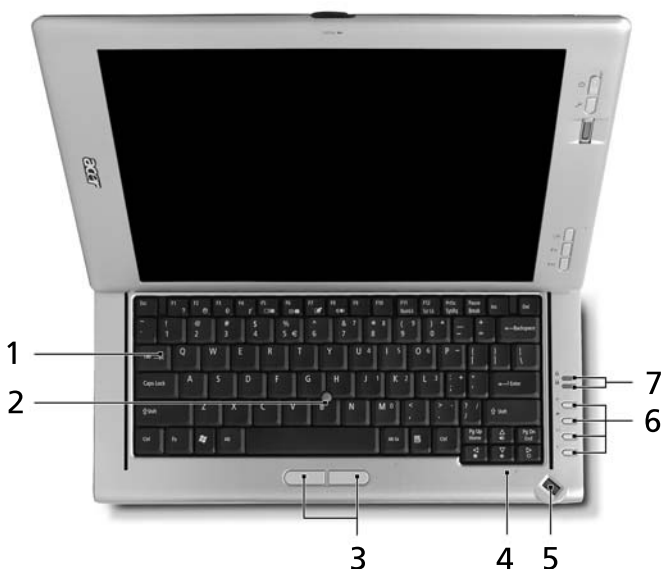



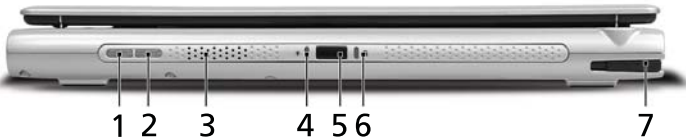

#	Item	Description
1	Keyboard	For entering data in notebook PC mode.
2	Built-in trackpoint	Touch-sensitive pointing device which functions like a computer mouse when used together with the click buttons.
3	Click buttons (left and right)	Function like the left and right mouse buttons when used together with the center-keyboard trackpoint.

#	Item	Description
4	Built-in microphone	Internal microphone for sound recording.
5	Scroll wheel	For up, down and enter functions.
6	Easy-launch buttons	Buttons for launching frequently used programs. See " Easy-launch buttons " on page 20 for more details.
7	Indicator lights	Light up when Caps Lock or Num Lock are activated.





Closed front view



#	Icon	Item	Description
1		Wireless communication button/indicator	Press to enable/disable the wireless function. Lights to indicate the status of wireless LAN communication.
2		Bluetooth communication button/indicator	Press to enable/disable Bluetooth function. Lights to indicate the status of Bluetooth communications.
3		Speaker	Provides sound.
4		Battery indicator	Lights up when battery is being charged.
5		Fast infrared (FIR) port	Interfaces with infrared printers, computers and other FIR-aware devices.
6		HDD indicator	Indicates when the hard disk drive is active.
7		Electromagnetic resonance (EMR) pen with eraser	For entering data in tablet PC mode.







Left view

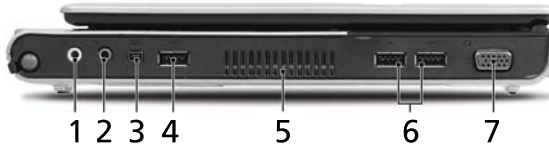

#	Icon	Item	Description
1		Ethernet (RJ-45) port	Connects to a gigabit Ethernet network.
2		Modem (RJ-11) port	Connects to a phone line.
3		Optical drive	Accepts recordable CDs and DVDs, depending on the drive type.
4		LED indicator	Lights up when the optical drive is active.
5		Optical drive eject button	Ejects the optical drive tray.
6		Emergency eject hole	Ejects the optical drive tray when the computer is turned off.
7		PC Card slot	Accepts one Type II PC Card.
8		PC Card slot eject button	Ejects the PC Card from the slot.
9		4-in-1 card reader	Accepts Memory Stick, Memory Stick Pro, MultiMediaCard (MMC), Secure Digital (SD). Note: Only one card can operate at any given time.



Right view

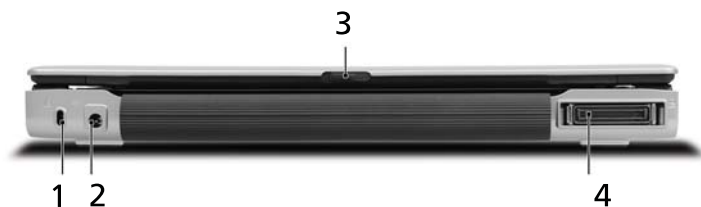

#	Icon	Item	Description
1		Headphone/ speakers line-out jack	Connects to audio line-out devices.
2		Microphone/ line-in jack	Accepts audio line-in devices (e.g. microphone or audio CD player).
3		IEEE 1394 port	Connects to IEEE 1394 devices.
4		USB 2.0 port	Connects to USB 2.0 devices (e.g. USB mouse or camera).
5		Ventilation slots	Keep computer cool during use.
6		USB 2.0 ports	Connect to USB 2.0 devices (e.g. USB mouse or camera).
7		External display (VGA) port	Connects to a display device (e.g. monitor or projector).

Rear view



#	Icon	Item	Description
1		Kensington lock slot	Connects to a Kensington-compatible computer security lock.
2		DC-in jack	Connects to an AC adapter.
3		Latch	Push to the right for releasing the LCD unit to convert from tablet to notebook mode.
4		Acer ezDock port	Connects to an Acer ezDock (optional).

Base view

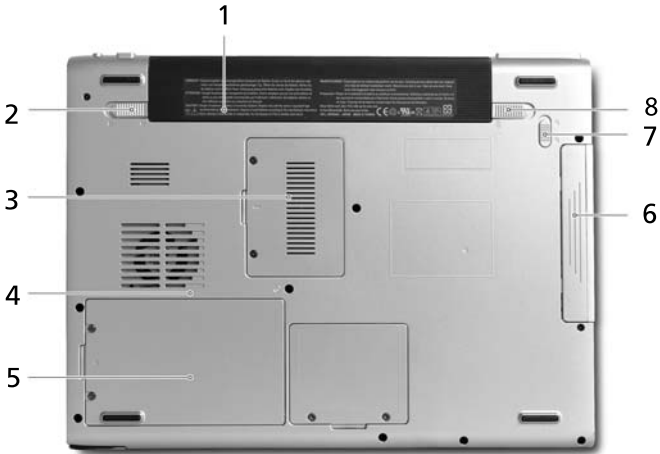

#	Item	Description
1	Battery bay	Houses the computer's battery pack.
2	Battery lock latch	Locks the battery in place.
3	Memory compartment	Houses the computer's main memory (secured with screws).
4	Cooling fan	Cools computer during use. Note: Do not cover or obstruct the opening of the fan.
5	Hard disk bay	Houses the computer's hard disk (secured with screws).
6	Optical drive	Internal optical drive (hot-swappable Acer MediaBay drive module is optional).
7	Optical drive release latch	Releases the optical drive module for removal.
8	Battery release latch	Releases the battery for removal.

Specifications

Operating system	Microsoft® Windows® XP Tablet PC Edition 2005
Platform	<p>Intel® Centrino™ Mobile Technology, featuring:</p> <ul style="list-style-type: none"> • Intel® Pentium® M processor 725/730/740/750/760/770 (2 MB L2 cache, 1.60/1.73/1.86/2/2.13 GHz, 533 MHz FSB) • Intel® 915PM/915GM chipset • Intel® PRO/Wireless 2915ABG network connection (dual-band tri-mode 802.11a/b/g or 802.11b/g) Wi-Fi CERTIFIED™ solution, supporting Acer SignalUp™ wireless technology <p>Intel® Celeron® M Processor 350/360/370/380 (1 MB L2 cache, 1.30/1.40/1.50/1.60 GHz, 400 MHz FSB)</p>
System memory	256/512 MB of DDR2 533 MHz memory, upgradeable to 2 GB using two soDIMM modules (dual-channel support)
Display and graphics	<p>12.1" XGA TFT LCD, 1024 x 768 resolution LCD slides to convert from notebook to tablet mode NVIDIA® GeForce™ Go 6200 with 64 MB of VRAM, supporting NVIDIA® TurboCache™ technology up to 256 MB, PCI Express™ and Microsoft® DirectX® 9.0 DualView™ support MPEG-2/DVD hardware-assisted capability</p>
Storage subsystem	<p>40/60/80/100 GB (4200 rpm) ATA/100 hard disk drive Acer MediaBay weight-saver module Acer MediaBay hot-swappable optical drive modules:</p> <ul style="list-style-type: none"> • 8X DVD-Dual double layer • DVD/CD-RW combo <p>4-in-1 card reader supporting Secure Digital (SD), MultiMediaCard (MMC), Memory Stick® (MS) and Memory Stick PRO™ (MS PRO)</p>
Dimensions and weight	315 (W) x 238 (D) x 35.3 (H) mm, (12.4 x 9.37 x 1.39 inches) 2.5 kg (5.5 lbs.) with 6-cell battery
Power subsystem	<p>ACPI 2.0 power management standard: supports Standby and Hibernation power-saving modes 3 cell Li-ion battery pack 6 cell Li-ion battery pack (optional) 9 cell Li-ion battery pack (optional) 2.5-hour rapid charge, 3.5-hour charge-in-use 3-pin 65 W AC adapter</p>

Input devices	84-/85-key keyboard with inverted "T" cursor layout Built-in trackpoint with two buttons 12 function keys, four cursor keys, two Windows® keys, hotkey controls, embedded numeric keypad, international language support Four easy-launch buttons: user-programmable button, Empowering Key, Internet, email Four tablet-mode buttons: Windows Security, Screen Rotate, Function, Escape 3-way scroll wheel (up/down/enter) Electromagnetic Resonance (EMR) pen with eraser
Audio	Audio system with one built-in speaker and microphone Sound Blaster Pro™ and MS-Sound compatible
Communication	Modem: 56K ITU V.92 with PTT approval; Wake-on-Ring ready LAN: gigabit Ethernet; Wake-on-LAN ready WLAN: Intel® PRO/Wireless 2915ABG network connection (802.11b/g or 802.11a/b/g) Wi-Fi CERTIFIED™ solution, supporting Acer SignalUp™ wireless technology WPAN: integrated Bluetooth® (manufacturing option)
I/O interface	124-pin Acer ezDock connector Three USB 2.0 ports 4-in-1 card reader (MS/MS PRO/MMC/SD) PC Card slot (Type II) IEEE 1394 port Fast infrared (FIR) port External display (VGA) port Ethernet (RJ-45) port Modem (RJ-11) port Microphone/line-in jack Headphones/speaker/line-out jack DC-in jack for AC adapter
Security	Kensington lock slot BIOS user and supervisor passwords Biometric fingerprint identification (manufacturing option)

Software	<p>Acer Empowering Technology (eDataSecurity / eLock / ePerformance / eRecovery / ePower / eSettings / ePresentation Management)</p> <p>Acer Soft Button</p> <p>Microsoft® Education Pack for Tablet PC (English version)</p> <p>Microsoft® Reader</p> <p>Acer Protector Suite QL fingerprint utility</p> <p>Acer Launch Manager</p> <p>Acer System Recovery CD</p> <p>Norton AntiVirus™</p> <p>CyberLink® PowerDVD™</p> <p>NTI CD-Maker™</p> <p>Adobe® Reader®</p>
Options and accessories	<p>Acer ezDock</p> <p>Acer MediaBay DVD-Dual double-layer drive module</p> <p>Acer MediaBay 2nd battery pack</p> <p>512 MB or 1 GB DDR2 533 MHz soDIMM modules</p> <p>External USB floppy disk drive</p>
Environment	<p>Temperature:</p> <ul style="list-style-type: none"> • Operating: 5° C to 35° C • Non-operating: -20° C to 65° C <p>Humidity (non-condensing):</p> <ul style="list-style-type: none"> • Operating: 20% to 80% • Non-operating: 20% to 80%
System compliance	<p>Mobile PC 2001</p> <p>ACPI 2.0</p> <p>DMI 2.0</p> <p>Wi-Fi®</p> <p>Cisco Compatible Extensions (CCX)</p>
Warranty	One-year International Travelers Warranty (ITW)



.....

Note: The specifications listed above are for reference only. The exact configuration of your PC depends on the model purchased.

Indicators

The computer has two easy-to-read status indicators to the right of the keyboard, and four on the front panel.



The battery, media, Bluetooth and wireless communication status indicators are visible even when the LCD display is closed.

Icon	Function	Description
	Caps Lock	Lights up when Caps Lock is activated.
	Num Lock	Lights up when Num Lock is activated.
	HDD	Indicates when the hard disk drive is active
	Battery	Lights up when battery is being charged.
	Bluetooth	Indicates the status of Bluetooth communication.
	Wireless LAN	Indicates the status of wireless LAN communication.



1. **Charging:** The light shows amber when the battery is charging.
2. **Fully charged:** The light shows green when in AC mode.

Easy-launch buttons

Located to the right of the keyboard are four buttons. These buttons are called easy-launch buttons. They are: mail, Web browser, Acer Empowering Key < *e* > and one user-programmable button.

Press < *e* > to run the Acer Empowering Technology. Please see "**Acer Empowering Technology**" on page 1. The mail and Web browser buttons are pre-set to email and Internet programs, but can be reset by users. To set the Web browser, mail and programmable buttons, run the Acer Launch Manager. See "**Launch Manager**" on page 31.



Easy-launch button	Default application
P	User-programmable
<i>e</i>	Acer Empowering Technology (user-programmable)
	Internet browser (user-programmable)
Mail	Email application (user-programmable)

Trackpoint and click buttons

The built-in trackpoint is a pointing device that senses movement on its surface. This means the cursor responds as you use your finger to move the trackpoint. Its central location on the keyboard provides optimum comfort and support.



Trackpoint basics

The following items show you how to use the trackpoint and click buttons:

- Using your finger, apply light, steady pressure on the trackpoint **(1)** to move the cursor.
- Press the left **(2)** and right **(3)** buttons located below the keyboard to perform selection and execution functions. These two buttons are similar to the left and right buttons on a mouse.

Scrolling basics

The 3-way scroll wheel is enabled for tablet- and keyboard-mode use.

- Use the jog wheel **(4)** to scroll up or down on a page. A click on the jog wheel executes the Enter function, similar to double-clicking a mouse.

Function	Left button	Right button	Scroll wheel
Execute	Quickly click twice.		Click on the jog wheel.
Select	Click once.		

Function	Left button	Right button	Scroll wheel
Drag	Click and hold, then use finger on the trackpoint to drag the cursor.		
Access context menu		Click once.	
Scroll			Use finger to roll scroll wheel lightly up or down in tablet or notebook mode.



.....

Note: When using these inputs, keep them — and your fingers — dry and clean. The scroll wheel is sensitive to finger movement; hence, the lighter the touch, the better the response. Tapping harder will not increase click button responsiveness.

Using the keyboard

The keyboard has full-sized keys with an embedded numeric keypad, as well as separate lock, cursor and Windows keys, and hotkey controls.

Lock keys and embedded numeric keypad

The keyboard has three lock keys which you can toggle on and off.





Lock key	Description
Caps Lock	When Caps Lock is on, all alphabetic characters typed are in uppercase.
Num Lock <Fn> + <F11>	When Num Lock is on, the embedded keypad is in numeric mode. The keys function as a calculator (complete with the arithmetic operators +, -, *, and /). Use this mode when you need to do a lot of numeric data entry. Another solution would be to connect an external keypad.
Scroll Lock <Fn> + <F12>	When Scroll Lock is on, the screen moves one line up or down when you press the up or down arrow keys respectively. Scroll Lock does not work with some applications.

The embedded numeric keypad functions like a desktop numeric keypad. It is indicated by small characters located on the upper right corner of the keycaps. To simplify the keyboard legend, cursor-control key symbols are not printed on the keys.

Desired access	Num Lock on	Num Lock off
Number keys on embedded keypad	Type numbers in a normal manner.	
Cursor-control keys on embedded keypad	Hold <Shift> while using cursor-control keys.	Hold <Fn> while using cursor-control keys.
Main keyboard keys	Hold <Fn> while typing letters on embedded keypad.	Type the letters in a normal manner.

Windows keys

The keyboard has two keys that perform Windows-specific functions.













Key	Description
 Windows key	<p>Pressed alone, this key has the same effect as clicking on the Windows Start button; it launches the Start menu. It can also be used with other keys to provide a variety of functions:</p> <ul style="list-style-type: none"> <Windows> + <Tab>: Activates the next Taskbar button. <Windows> + <E>: Opens the My Computer window. <Windows> + <F1>: Opens Help and Support Center. <Windows> + <F>: Opens the Search Results window. <Windows> + <R>: Opens the Run dialog box. <Windows> + <M>: Minimizes all windows. <Shift> + <Windows> + <M>: Undoes the minimize all windows action.
 Application key	<p>This key has the same effect as clicking the right mouse button; it opens the application's context menu.</p>

Hotkeys

The computer employs hotkeys or key combinations to access many computer controls, including screen brightness, volume output and the BIOS utility.

To activate hotkeys, press and hold the <Fn> key before pressing the other key in the hotkey combination.



Hotkey	Icon	Function	Description
<Fn> + <F1>		Hotkey help	Displays help on hotkeys.
<Fn> + <F2>		Acer eSettings	Launches Acer eSettings in Acer Empowering Technology. See " Acer Empowering Technology " on page 1.
<Fn> + <F3>		Acer ePower Management	Launches Acer ePower Management. See " Acer Empowering Technology " on page 1.
<Fn> + <F4>		Sleep	Puts the computer in Sleep mode.
<Fn> + <F5>		Display toggle	Switches display output between the display screen, external monitor (if connected) and both.
<Fn> + <F6>		Screen blank	Turns the display screen backlight off to save power. Press any key to return.
<Fn> + <F7>		Touchpad toggle	Turns the internal touchpad on and off.
<Fn> + <F8>		Speaker toggle	Turns the speakers on and off.
<Fn> + <↑>		Volume up	Increases the sound volume.
<Fn> + <↓>		Volume down	Decreases the sound volume.
<Fn> + <↔>		Brightness up	Increases the screen brightness.
<Fn> + <↔>		Brightness down	Decreases the screen brightness.

Special keys

You can locate the Euro symbol and the US dollar sign at the upper-center and/or bottom-right of your keyboard.



The Euro symbol

- 1 Open a text editor or word processor.
- 2 Hold <Alt Gr> and then press the <5> key at the upper-center of the keyboard.



.....

Note: Some fonts and software do not support the Euro symbol. Please refer to www.microsoft.com/typography/faq/faq12.htm for more information.

The US dollar sign

- 1 Open a text editor or word processor.
- 2 Hold <Shift> and then press the <4> key at the upper-center of the keyboard.



.....

Note: This function varies according to the language settings.

Ejecting the optical (CD or DVD) disk

To eject the optical disk from the slot-load / tray-in optical drive when the computer is turned on, press the drive eject button.



When the power is off, you can eject an optical disk by inserting a pin or paper clip into the emergency eject hole.

Using a computer security lock

A security keylock notch, located on the chassis of the computer, lets you connect a Kensington-compatible computer security lock.



Wrap the computer security lock cable around an immovable object such as a table or handle of a locked drawer. Insert the lock into the notch and turn the key to secure the lock. Some keyless models are also available.

Audio

The computer comes with 16-bit high-fidelity AC'97 audio, and one speaker.



Adjusting the volume

Adjusting the volume on the computer is easy. See **"Hotkeys"** on **page 24** for more information on adjusting the speaker volume.

Using the system utilities



Note: The system utilities work under Microsoft Windows XP only.

Acer Protector Suite QL fingerprint utility



Note: This feature is only available on certain models.

Acer Protector Suite QL provides fingerprint-based biometric identification to control access to your computer's drives. The utility is accessed via the Protector Suite icon on the taskbar. Below is a brief description of the steps for fingerprint scanning and user enrollment. For full details of Protector Suite QL's programmable functions, open the utility and follow the step-by-step guide.

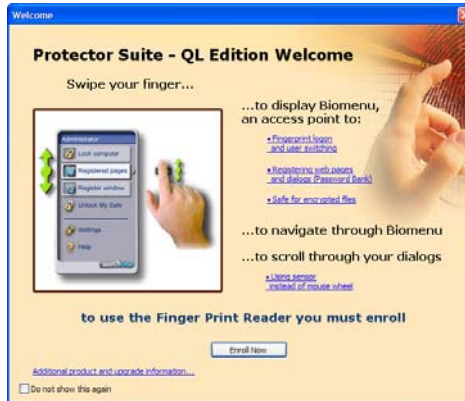

Password choice

To enter Protector Suite QL, enter your password. If you are using the utility for the first time, you may choose your own password. Do not share your password with others. Make sure to remember your password.

Correct scanning procedure

- 1 Position the first joint of the finger you are scanning beyond the sensor edge.

- 2 Maintain finger contact with the sensor while sliding the finger across it in a straight line.
- 3 The application window will indicate a successful scan. If the scan quality is poor, repeat the procedure.



.....

Note: Make sure to keep the finger flat throughout the scanning procedure.

User's Fingers

You can use Protector Suite QL to create fingerprint samples to identify a user. The application can record prints of up to all 10 fingers, depending on the level of security required.

- Follow the "User's Fingers" screen commands to record the fingerprints of authorized users. The utility must record three successful scans of each print before it can be accepted into the system.

User Enrollment

- 1 Boot Security protects your computer by subjecting boot-ups to fingerprint identification. To use this function, select "**Enable Boot Security**" in the User Enrollment application window
- 2 Boot Security can also be enabled at a later date via the Settings menu.

Launch Manager

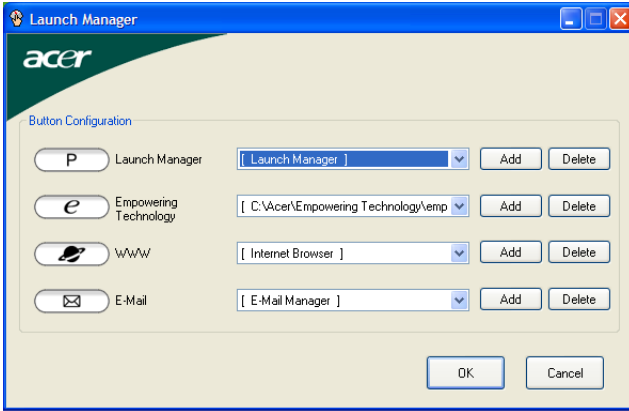

Launch Manager allows you to set the four easy-launch buttons located above the keyboard. See **"Easy-launch buttons"** on page 20 for the location of the easy-launch buttons.

You can access the Launch Manager by clicking on **Start > All Programs**, and then **Launch Manager** to start the application.

Norton AntiVirus

Norton AntiVirus is an anti-virus software that finds and repairs infected files, and protects against viruses to keep your computer data safe and secure.

How do I check for viruses?

A Full System Scan scans all files on your computer. To perform a system scan:

- 1 Start Norton AntiVirus.

Double click on the **Norton AntiVirus** icon on the desktop or click on the **Start** menu in the Windows taskbar, highlight **Programs**, and select **Norton AntiVirus**.

- 2 In the Norton AntiVirus main window, click **Scan for Viruses**.

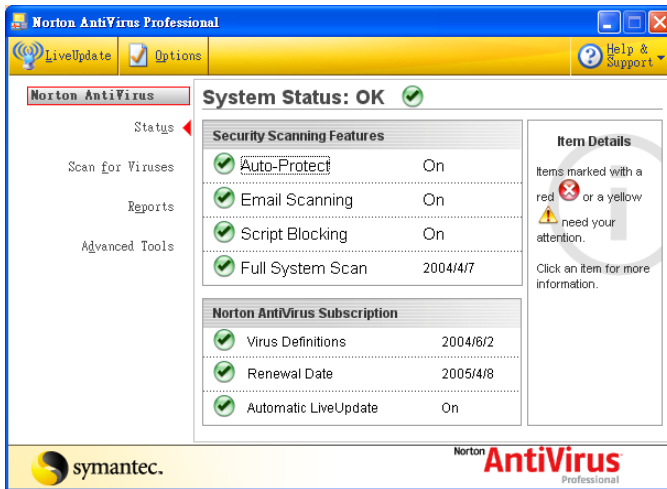

- 3 In the **Scan for Viruses** panel, click **Scan My Computer**.
- 4 Under **Actions**, click **Scan**.
- 5 When the scan is complete, a scan summary appears. Click **Finished**.

You can schedule customized virus scans that run unattended on specific dates and times or at periodic intervals. If you are using the computer when the scheduled scan begins, it runs in the background so that you do not have to stop working.

For more information, refer to the Norton AntiVirus Help menu.

Frequently asked questions

The following is a list of possible situations that may arise during the use of your computer. Easy solutions are provided for each one.

I pressed the power button, but the computer doesn't start or boot up.

Look at the power indicator:

- If it is not lit, no power is being supplied to the computer. Check the following:
 - If you are using the battery, it may be low and unable to power the computer. Connect the AC adapter to recharge the battery pack.
 - Make sure that the AC adapter is properly plugged into the computer and to the power outlet.
- If it is lit, check the following:
 - Is a non-bootable (non-system) disk in the external USB floppy drive? Remove or replace it with a system disk and press **<Ctrl> + <Alt> + ** to restart the system.

Nothing appears on the screen.

The computer's power management system automatically blanks the screen to save power. Press any key to turn the display back on.

If pressing a key does not turn the display back on, three things might be the cause:

- The brightness level might be too low. Press **<Fn> + <→>** (increase) to adjust the brightness level.
- The display device might be set to an external monitor. Press the display toggle hotkey **<Fn> + <F5>** to toggle the display back to the computer.
- If the Sleep indicator is lit, the computer is in Sleep mode. Press and release the power button to resume.

Image is not full-screen.

Each computer display has a different native resolution depending on the screen. If you set the resolution lower than this native resolution, the screen expands to fill the computer display. Right-click on your Windows desktop and select **Properties** to bring up the "Display Properties" dialog box. Then click on the **Settings** tab to make sure that the resolution is set to the appropriate resolution. Resolutions lower than the specified resolution are not full-screen on the computer or on an external monitor.

No audio is heard from the computer.

Check the following:

- The volume may be muted. In Windows, look at the volume control (speaker) icon on the taskbar. If it is crossed out, click on the icon and deselect the **Mute all** option.
- The volume level may be too low. In Windows, look at the volume control icon on the taskbar. You can also use the volume control buttons to adjust the volume. See "**Hotkeys**" on page 24 for more detail.
- If headphones, earphones or external speakers are connected to the line-out port on the computer, the internal speakers automatically turn off.

I want to eject the optical drive tray without turning on the power.

There is a mechanical eject hole on the optical drive. Simply insert the tip of a pen or paperclip into the hole and push to eject the tray. (If your computer's optical drive is a slot-load model, it will not have an eject hole).

The keyboard does not respond.

Try attaching an external keyboard to a USB port on the computer. If it works, contact your dealer or an authorized service center as the internal keyboard cable may be loose.

The infrared port does not work.

Check the following:

- Make sure that the infrared ports of the two devices are facing each other (+/- 15 degrees) a maximum of one meter apart.
- Make sure there is a clear path between the two infrared ports. Nothing should be blocking the ports.
- Make sure you have the appropriate software running on both devices (for file transfers) or you have the appropriate drivers (for printing to an infrared printer).
- During the POST, press <F2> to access the BIOS utility and verify that the infrared port is enabled.
- Make sure both devices are IrDA-compliant.

The printer does not work.

Check the following:

- Make sure that the printer is connected to a power outlet and that it is

turned on.

- Make sure that the printer cable is connected securely to the computer's parallel port or a USB port and the corresponding port on the printer.

I want to set up my location to use the internal modem.

To properly use your communication software (e.g. HyperTerminal), you need to set up your location:

- 1 Click on **Start > Settings > Control Panel**.
- 2 Double-click on **Phone and Modem Options**.
- 3 Click on **Dialing Rules** and begin setting up your location.

Refer to the Windows manual.



.....

Note: Please note, on first booting your notebook, that you can skip the Internet Connection setup, as it is not necessary to complete the installation of your Operating System. After the Operating System is set up, you can proceed with the Internet Connection setup.

I want to restore my computer to its original settings without recovery CDs.



.....

Note: If your system is the multilingual version, the operating system and language you choose when you first turn on the system will be the only option for future recovery operations.

This recovery process helps you restore the C: drive with the original software content that is installed when you purchase your notebook. Follow the steps below to rebuild your C: drive. (Your C: drive will be reformatted and all data will be erased.) It is important to back up all data files before using this option.

Before performing a restore operation, please check the BIOS settings.

- 1 Check to see if **Acer disk-to-disk recovery** is enabled or not.
- 2 Make sure the **D2D Recovery** setting in **Main** is **Enabled**.
- 3 Exit the BIOS utility and save changes. The system will reboot.



.....

Note: To activate the BIOS utility, press **<F2>** during POST.

To start the recovery process:

- 1 Restart the system.
- 2 While the Acer logo is showing, press <Alt> + <F10> at the same time to enter the recovery process.
- 3 Refer to the onscreen instructions to perform system recovery.



.....

Important! This feature occupies 2 to 3 GB in a hidden partition on your hard disk.

Requesting service

International Travelers Warranty (ITW)

Your computer is backed by an International Travelers Warranty (ITW) that gives you security and peace of mind when traveling. Our worldwide network of service centers is there to give you a helping hand.

An ITW passport comes with your computer. This passport contains all you need to know about the ITW program. A list of available, authorized service centers is in this handy booklet. Read this passport thoroughly.

Always have your ITW passport on hand, especially when you travel, to receive the benefits from our support centers. Place your proof-of-purchase in the flap located inside the front cover of the ITW passport.

If the country you are traveling in does not have an Acer-authorized ITW service site, you can still get in contact with our offices worldwide. Please consult <http://global.acer.com>.

Before you call

Please have the following information available when you call Acer for online service, and please be at your computer when you call. With your support, we can reduce the amount of time a call takes and help solve your problems efficiently. If there are error messages or beeps reported by your computer, write them down as they appear on the screen (or the number and sequence in the case of beeps).

You are required to provide the following information:

Name: _____

Address: _____

Telephone number: _____

Machine and model type: _____

Serial number: _____

Date of purchase: _____

Using your computer in tablet mode

Your computer is designed for convenience, ergonomic use and portability. Running the Windows XP Tablet PC Edition 2005 operating system, your TravelMate utilizes an EMR stylus for pen-based input. Software developed specifically for the computer allows for both handwriting recognition converted to application text, or handwriting captured as rich digital ink for manipulation, editing and formatting.

Writing in tablet mode

Your Acer TravelMate C200 comes ready for use in tablet mode. Just remove the EMR stylus from the slot to begin pen-based input.



Converting to notebook mode

1) Slide the LCD latch to the right.



2) Gently pull the display unit from the bottom until it locks into the upright position and use the keyboard to enter data.

Converting to tablet mode

1) To return to tablet mode, slide down the display unit from both sides.



2) Push down on the LCD gently with both hands on the top corners until it clicks shut.



Warning: Make sure that the detachable band of the protective screen cover is not bunched underneath the LCD unit before converting to tablet mode. Never use excessive pressure to shut the LCD unit.

Taking your notebook PC with you

This section gives you tips and hints to consider when moving around or traveling with your computer.

Disconnecting from the desktop

Follow these steps to disconnect your computer from external accessories:

- 1 Save any open files.
- 2 Remove any media, floppy disks or compact disks from the drive(s).
- 3 Shut down the computer.
- 4 Close and latch the display unit.
- 5 Disconnect the cord from the AC adapter.
- 6 Disconnect the keyboard, pointing device, printer, external monitor and other external devices.
- 7 Disconnect the Kensington lock if you are using one to secure the computer.

Moving around

When you are just moving within short distances, for example, from your office desk to a meeting room.

Preparing the computer

Click on **Start, Turn Off Computer**, then click on **Turn Off** (Windows XP).

Or:

You can put the computer in Sleep mode by pressing **<Fn> + <F4>**. Then close and latch the display.

When you are ready to use the computer again, press and release the power button.



Note: If the Sleep indicator is off, the computer has entered Hibernation mode and is turned off. If the power indicator is off but the Sleep indicator is on, the computer has entered Sleep mode. In both cases, press and release the power button to turn the computer back on. Note that the computer may enter Hibernation mode after being in Sleep mode for a period of time.

What to bring to meetings

If your meeting is relatively short, you probably do not need to bring anything with you other than your computer. If your meeting will be longer, or if your battery is not fully charged, you may want to bring the AC adapter with you to plug in your computer in the meeting room.

If the meeting room does not have an electrical outlet, reduce the drain on the battery by putting the computer in Sleep mode. Press **<Fn> + <F4>** whenever you are not actively using the computer. To resume, press and release the power button.

Taking the computer home

When you are moving from your office to your home or vice versa.

Preparing the computer

After disconnecting the computer from your desktop, follow these steps to prepare the computer for the trip home:

- Check that you have removed all media and compact disks from the drive(s). Failure to remove the media can damage the drive head.
- Pack the computer in a protective case that can prevent the computer from sliding around and cushion it if it should fall.



.....

Caution: Avoid packing items closely next to the top of the computer. Pressure against the display unit can damage the screen.

What to take with you

Unless you have the items at home, take the following with you:

- AC adapter and power cord
- The printed User's Guide

Special considerations

Follow these guidelines to protect your computer while traveling to and from work:

- Minimize the effects of temperature changes by keeping the computer with you.
- If you need to stop for an extended period of time and cannot carry the

computer with you, leave the computer in the trunk of the car to avoid exposing the computer to excessive heat.

- Changes in temperature and humidity can cause condensation. Allow the computer to return to room temperature, and inspect the screen for condensation before turning on the computer. If the temperature change is greater than 10 °C (18 °F), allow the computer to come to room temperature slowly. If possible, leave the computer for 30 minutes in an environment with a temperature between outside and room temperature.

Setting up a home office

If you frequently work on your computer at home, you may want to purchase a second AC adapter for use at home. With a second AC adapter, you can avoid carrying the extra weight to and from home.

If you use your computer at home for significant periods of time, you might also want to add an external keyboard, monitor or mouse.

Traveling with the computer

When you are moving within a larger distance, for instance, from your office building to a client's office building or traveling locally.

Preparing the computer

Prepare the computer as if you were taking it home. Make sure that the battery in the computer is charged. Airport security may require you to turn on your computer when carrying it into the gate area.

What to take with you

Take the following items with you:

- AC adapter
- Spare, fully-charged battery pack(s)
- Additional printer driver files if you plan to use another printer

Special considerations

In addition to the guidelines for taking the computer home, follow these guidelines to protect your computer while traveling:

- Always take the computer as carry-on luggage.
- If possible, have the computer inspected by hand. Airport security X-ray machines are safe, but do not put the computer through a metal detector.

- Avoid exposing floppy disks to hand-held metal detectors.

Traveling internationally with the computer

When you are moving from country to country.

Preparing the computer

Prepare the computer as you would normally prepare it for traveling.

What to bring with you

Bring the following items with you:

- AC adapter
- Power cords that are appropriate for the country to which you are traveling
- Spare, fully-charged battery packs
- Additional printer driver files if you plan to use another printer
- Proof of purchase, in case you need to show it to customs officials
- International Travelers Warranty passport

Special considerations

Follow the same special considerations as when traveling with the computer. In addition, these tips are useful when traveling internationally:

- When traveling in another country, check that the local AC voltage and the AC adapter power cord specifications are compatible. If not, purchase a power cord that is compatible with the local AC voltage. Do not use converter kits sold for appliances to power the computer.
- If you are using the modem, check if the modem and connector is compatible with the telecommunications system of the country you are traveling in.

Securing your computer

Your computer is a valuable investment that you need to take care of. Learn how to protect and take care of your computer.

Security features include hardware and software locks — a security notch and passwords.

Using a computer security lock

A security keylock notch, located on the chassis of the computer, lets you connect a Kensington-compatible computer security lock.

Wrap a computer security lock cable around an immovable object such as a table or handle of a locked drawer. Insert the lock into the notch and turn the key to secure the lock. Some keyless models are also available.

Using passwords

Passwords protect your computer from unauthorized access. Setting these passwords creates several different levels of protection for your computer and data:

- Supervisor Password prevents unauthorized entry into the BIOS utility. Once set, you must enter this password to gain access to the BIOS utility. See **"BIOS utility" on page 51**.
- User Password secures your computer against unauthorized use. Combine the use of this password with password checkpoints on boot-up and resume from Hibernation for maximum security.
- Password on Boot secures your computer against unauthorized use. Combine the use of this password with password checkpoints on boot-up and resume from Hibernation for maximum security.



Important! Do not forget your Supervisor Password! If you forget your password, please get in touch with your dealer or an authorized service center.

Entering passwords

When a password is set, a password prompt appears in the center of the display screen.

- When the Supervisor Password is set, a prompt appears when you press <F2> to enter the BIOS utility at boot-up.
- Type the Supervisor Password and press <Enter> to access the BIOS utility. If you enter the password incorrectly, a warning message appears. Try again and press <Enter>.
- When the User Password is set and the password on boot parameter is enabled, a prompt appears at boot-up.
- Type the User Password and press <Enter> to use the computer. If you enter the password incorrectly, a warning message appears. Try again and press <Enter>.



.....

Important! You have three chances to enter a password. If you fail to enter the password correctly after three tries, the system halts. Press and hold the power button for four seconds to shut down the computer. Then turn on the computer again, and try again.

Setting passwords

You can set passwords using the BIOS utility.

Expanding through options

Your notebook PC offers you a complete mobile computing experience.

Connectivity options

Ports allow you to connect peripheral devices to your computer as you would with a desktop PC. For instructions on how to connect different external devices to the computer, read the following section.

Fax/data modem

Your computer has a built-in V.92 56 Kbps fax/data modem.



.....

Warning! This modem port is not compatible with digital phone lines. Plugging this modem into a digital phone line will damage the modem.

To use the fax/data modem port, connect a phone cable from the modem port to a telephone jack.

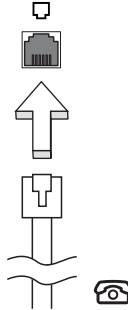

.....

Warning! Please make sure that the cable you use is appropriate for the country in which you are working.

Built-in network feature

The built-in network feature allows you to connect your computer to an Ethernet-based network.

To use the network feature, connect an Ethernet cable from the Ethernet (RJ-45) port on the chassis of the computer to a network jack or hub on your network.

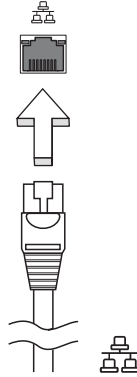

Fast Infrared (FIR)

The computer's Fast Infrared (FIR) port allows you to do wireless data transfer with other IR-aware computers and peripherals such as PDAs, mobile phones, and infrared printers. The infrared port can transfer data at speeds of up to 4 Mbps at a distance of up to one meter.

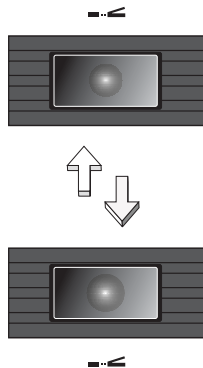

Universal Serial Bus (USB)

The USB 2.0 port is a high-speed serial bus which allows you to connect USB peripherals without taking up precious system resources.

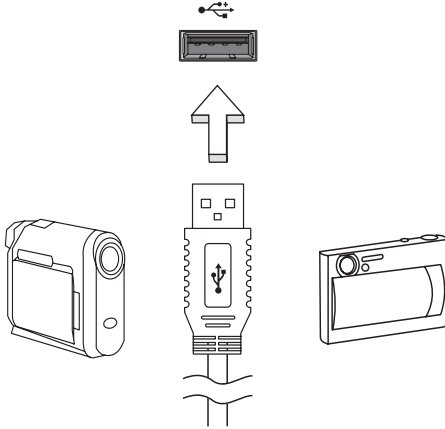

IEEE 1394 port

The computer's IEEE 1394 port allows you to connect to an IEEE 1394-compatible device like a video camera or digital camera. See your video or digital camera's documentation for details.

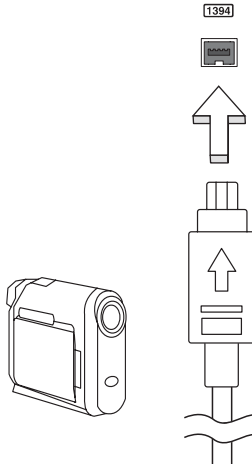

The computer's IEEE 1394 port allows you to connect to an IEEE 1394 supported devices like a DVD/CD-RW combo or DVD-Dual drive.

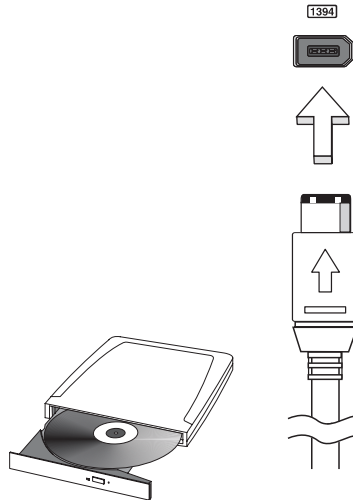

PC Card slot

The computer's Type II PC Card slot accepts PC Cards that enhance the usability and expandability of the computer. These cards should have a PC Card logo on them.

PC Cards (formerly PCMCIA) are add-on cards for portable computers, giving you expansion possibilities long afforded by desktop PCs. Popular PC Cards include flash, fax/data modem, wireless LAN and SCSI cards. CardBus improves on 16-bit PC card technology by expanding the bandwidth to 32 bits.



.....
Note: Refer to your card's manual for details on how to install and use the card, and its functions.

Inserting a PC Card

Insert the card into the slot and make the proper connections (e.g., network cable), if necessary. See your card manual for details.

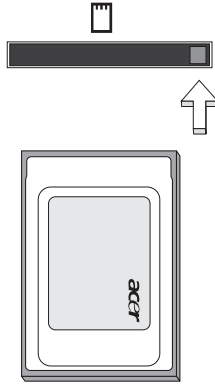

Ejecting a PC Card

Before ejecting a PC Card:

- 1 Exit the application using the card.
- 2 Left-click on the PC Card icon on the taskbar and stop the card operation.
- 3 Press the slot eject button to pop out the eject button; then press it again to eject the card.

Installing memory

Follow these steps to install memory:

- 1 Turn off the computer, unplug the AC adapter (if connected) and remove the battery pack. Then turn the computer over to access its base.
- 2 Remove the screws from the memory cover; then lift up and remove the memory cover.

- 3 (a) Insert the memory module diagonally into the slot, then (b) gently press it down until it clicks into place.

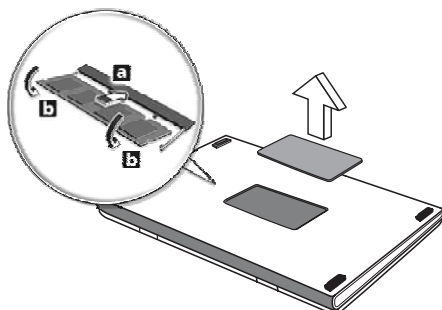

- 4 Replace the memory cover and secure it with the screw.
- 5 Reinstall the battery pack, and reconnect the AC adapter.
- 6 Turn on the computer.

The computer automatically detects and reconfigures the total memory size. Please consult a qualified technician or contact your local Acer dealer.

BIOS utility

The BIOS utility is a hardware configuration program built into your computer's BIOS.

Your computer is already properly configured and optimized, and you do not need to run this utility. However, if you encounter configuration problems, you may need to run it.

To activate the BIOS utility, press <F2> during the POST; while the notebook PC logo is being displayed.

Boot sequence

To set the boot sequence in the BIOS utility, activate the BIOS utility, then select **Boot** from the categories listed at the top of the screen.

Enable disk-to-disk recovery

To enable disk-to-disk recovery (hard disk recovery), activate the BIOS utility, then select **Main** from the categories listed at the top of the screen. Find **D2D Recovery** at the bottom of the screen and use the <F5> and <F6> keys to set this value to **Enabled**.

Password

To set a password on boot, activate the BIOS utility, then select **Security** from the categories listed at the top of the screen. Find **Password on boot:** and use the <F5> and <F6> keys to enable this feature.

Using software

Playing DVD movies

When the DVD drive module is installed in the optical drive bay, you can play DVD movies on your computer.

- 1 Eject the DVD tray and insert a DVD movie disk; then close the DVD tray.



Important! When you launch the DVD player for the first time, the program asks you to enter the region code. DVD disks are divided into 6 regions. Once your DVD drive is set to a region code, it will play DVD disks of that region only. You can set the region code a maximum of five times (including the first time), after which the last region code set will remain permanent. Recovering your hard disk does not reset the number of times the region code has been set. Refer to the table below for DVD movie region code information.

- 2 The DVD movie will automatically play after a few seconds.

Region code	Country or region
1	USA, Canada
2	Europe, Middle East, South Africa, Japan
3	Southeast Asia, Taiwan, South Korea
4	Latin America, Australia, New Zealand
5	Former USSR, parts of Africa, India
6	People's Republic of China



Note: To change the region code, insert a DVD movie of a different region into the DVD drive. Please refer to the online help for more information.

Power management

This computer has a built-in power management unit that monitors system activity. System activity refers to any activity involving one or more of the following devices: keyboard, mouse, hard disk, peripherals connected to the computer, and video memory. If no activity is detected for a period of time (called an inactivity timeout), the computer stops some or all of these devices in order to conserve energy.

This computer employs a power management scheme that supports the advanced configuration and power interface (ACPI), which allows for maximum power conservation and maximum performance at the same time. Windows handles all power-saving chores for your computer.

Acer eRecovery Management

Acer eRecovery Management is a tool to quickly backup and restore the system. You can create and save a backup of the current system configuration to hard disk, CD or DVD.

Acer eRecovery Management consists of the following functions:

- 1 Create backup
- 2 Restore from backup
- 3 Create factory default image CD
- 4 Re-install bundled software without CD
- 5 Change Acer eRecovery Management password

This chapter will guide you through each process.



.....

Note: This feature is only available on certain models. For systems that do not have a built-in optical disk burner, plug in an external USB or IEEE 1394-compatible optical disk burner before entering Acer eRecovery Management for optical disk-related tasks.

Create backup

You can create and save backup images to hard disk, CD or DVD.

- 1 Boot to Windows XP
- 2 Press **<Alt> + <F10>** to open the Acer eRecovery Management utility.
- 3 Enter the password to proceed. The default password is six zeros.
- 4 In the Acer eRecovery Management window, select **Recovery settings** and click **Next**.
- 5 In the Recovery settings window, select **Backup snapshot image** and click **Next**.
- 6 Select the backup method.
 - a Use **Backup to HDD** to store the backup disk image on drive D:.
 - b **Backup to optical device** to store the backup image on CD or DVD.
- 7 After choosing the backup method, click **Next**.

Follow the instructions on screen to complete the process.

Restore from backup

You can restore backups previously created (as stated in the **Create backup** section) from hard disk, CD or DVD.

- 1 Boot to Windows XP.
- 2 Press **<Alt> + <F10>** to open the Acer eRecovery Management utility.
- 3 Enter the password to proceed. The default password is six zeros.
- 4 In the Acer eRecovery Management window, select **Recovery actions** and click **Next**.
- 5 Select the desired restore action and follow the onscreen instructions to complete the restore process.



.....

Note: The "Restore C:" item is enabled only if there is a user backup stored on the hard disk (D:\). Please refer to the **Create backup** section.

Create factory default image CD

When the System CD and Recovery CD are not available, you can create them by using this feature.

- 1 Boot to Windows XP.
- 2 Press **<Alt> + <F10>** to open the Acer eRecovery Management utility.
- 3 Enter the password to proceed. The default password is six zeros.
- 4 In the Acer eRecovery Management window, select **Recovery settings** and click **Next**.
- 5 In the Recovery settings window, select **Burn image to disk** and click **Next**.
- 6 In the Burn image to disk window, select **01. Factory default image** and click **Next**.
- 7 Follow the instructions on screen to complete the process.

Re-install bundled software without CD

Acer eRecovery Management stores pre-loaded software internally for easy driver and application re-installation.

- 1 Boot to Windows XP.
- 2 Press **<Alt> + <F10>** to open the Acer eRecovery Management utility.
- 3 Enter the password to proceed. The default password is six zeros.
- 4 In the Acer eRecovery Management window, select **Recovery actions** and click **Next**.
- 5 In the Recovery settings window, select **Reinstall applications/drivers** and click **Next**.
- 6 Select the desired driver/application and follow the instructions on screen to re-install.

At first launch, Acer eRecovery Management prepares all the needed software and may take few seconds to bring up the software content window.

Change password

Acer eRecovery Management and Acer disk-to-disk recovery are protected by a password that can be changed by the user. Follow the steps below to change the password in Acer eRecovery Management.

- 1 Boot to Windows XP.
- 2 Press **<Alt> + <F10>** to open the Acer eRecovery Management utility.
- 3 Enter the password to proceed. The default password is six zeros.

- 4 In the Acer eRecovery Management window, select **Recovery settings** and click **Next**.
- 5 In the Recovery settings window, select **Password: Change Acer eRecovery Management password** and click **Next**.
- 6 Follow the instructions on screen to complete the process.



.....

Note: If the system crashes, and will not boot to Windows, you can run Acer disk-to-disk recovery to restore the factory default image under DOS mode.

Troubleshooting

This chapter shows you how to deal with common system problems. Read it before calling a technician if a problem occurs. Solutions to more serious problems require opening up the computer. Do not attempt to open the computer yourself; contact your dealer or authorized service center for assistance.

Troubleshooting tips

This notebook PC incorporates an advanced design that delivers onscreen error message reports to help you solve problems.

If the system reports an error message or an error symptom occurs, see "Error messages" below. If the problem cannot be resolved, contact your dealer. See **"Requesting service" on page 36**.

Error messages

If you receive an error message, note the message and take the corrective action. The following table lists the error messages in alphabetical order together with the recommended course of action.

Error messages	Corrective action
CMOS battery bad	Contact your dealer or an authorized service center.
CMOS checksum error	Contact your dealer or an authorized service center.
Disk boot failure	Insert a system (bootable) disk into the floppy drive (A:), then press <Enter> to reboot.
Equipment configuration error	Press <F2> (during POST) to enter the BIOS utility, then press Exit in the BIOS utility to reboot.
Hard disk 0 error	Contact your dealer or an authorized service center.
Hard disk 0 extended type error	Contact your dealer or an authorized service center.
I/O parity error	Contact your dealer or an authorized service center.
Keyboard error or no keyboard connected	Contact your dealer or an authorized service center.
Keyboard interface error	Contact your dealer or an authorized service center.
Memory size mismatch	Press <F2> (during POST) to enter the BIOS utility, then press Exit in the BIOS utility to reboot.

If you still encounter problems after going through the corrective measures, please contact your dealer or an authorized service center for assistance. Some problems may be solved using the BIOS utility.

Regulations and safety notices

ENERGY STAR guidelines compliance

As an ENERGY STAR partner, Acer Inc. has determined that this product meets the ENERGY STAR guidelines for energy efficiency.

FCC notice

This device has been tested and found to comply with the limits for a Class B digital device pursuant to Part 15 of the FCC rules. These limits are designed to provide reasonable protection against harmful interference in a residential installation. This device generates, uses, and can radiate radio frequency energy and, if not installed and used in accordance with the instructions, may cause harmful interference to radio communications.

However, there is no guarantee that interference will not occur in a particular installation. If this device does cause harmful interference to radio or television reception, which can be determined by turning the device off and on, the user is encouraged to try to correct the interference by one or more of the following measures:

- Reorient or relocate the receiving antenna.
- Increase the separation between the device and receiver.
- Connect the device into an outlet on a circuit different from that to which the receiver is connected.
- Consult the dealer or an experienced radio/television technician for help.

Notice: Shielded cables

All connections to other computing devices must be made using shielded cables to maintain compliance with FCC regulations.

Notice: Peripheral devices

Only peripherals (input/output devices, terminals, printers, etc.) certified to comply with the Class B limits may be attached to this equipment. Operation with non-certified peripherals is likely to result in interference to radio and TV reception.

Caution

Changes or modifications not expressly approved by the manufacturer could void the user's authority, which is granted by the Federal Communications Commission, to operate this computer.

Operation conditions

This device complies with Part 15 of the FCC Rules. Operation is subject to the following two conditions: (1) this device may not cause harmful interference, and (2) this device must accept any interference received, including interference that may cause undesired operation.

Notice: Canadian users

This Class B digital apparatus complies with Canadian ICES-003.

Remarque à l'intention des utilisateurs canadiens

Cet appareil numérique de la classe B est conforme à la norme NMB-003 du Canada.

Declaration of Conformity for EU countries

Hereby, Acer, declares that this notebook PC series is in compliance with the essential requirements and other relevant provisions of Directive 1999/5/EC. (Please visit <http://global.acer.com/products/notebook/reg-nb/index.htm> for complete documents.)

Compliant with Russian regulatory certification



ME61

Modem notices

Notice for USA

This equipment complies with Part 68 of the FCC rules. Located on the modem is a label that contains, among other information, the FCC Registration Number and Ringer Equivalence Number (REN) for this equipment. Upon request, you must provide this information to your telephone company.

If your telephone equipment causes harm to the telephone network, the telephone company may discontinue your service temporarily. If possible, they will notify you in advance. But, if advance notice is not practical, you will be notified as soon as possible. You will also be informed of your right to file a complaint with the FCC.

Your telephone company may make changes in its facilities, equipment, operations, or procedures that could affect the proper functioning of your equipment. If they do, you will be notified in advance to give you an opportunity to maintain uninterrupted telephone service.

If this equipment should fail to operate properly, disconnect the equipment from the phone line to determine if it is causing the problem. If the problem is with the equipment, discontinue use and contact your dealer or vendor.



.....
Caution: To reduce the risk of fire, use only No. 26 AWG or larger UL Listed or CSA Certified Telecommunication Line Cord.

TBR 21

This equipment has been approved [Council Decision 98/482/EC - "TBR 21"] for single terminal connection to the Public Switched Telephone Network (PSTN). However, due to differences between the individual PSTNs provided in different countries, the approval does not, of itself, give an unconditional assurance of successful operation on every PSTN termination point. In the event of problems, you should contact your equipment supplier in the first instance.

List of applicable countries

EU member states as of May 2004 are: Belgium, Denmark, Germany, Greece, Spain, France, Ireland, Italy, Luxembourg, the Netherlands, Austria, Portugal, Finland, Sweden, United Kingdom Estonia, Latvia, Lithuania, Poland, Hungary, Czech Republic, Slovak Republic, Slovenia, Cyprus and Malta. Usage allowed in the countries of European Union, as well as Norway, Switzerland, Iceland and Liechtenstein. This device must be used in strict accordance with the regulations and constraints in the country of use. For further information, please contact local office in the country of use.

Notice for Australia

For safety reasons, only connect headsets with a telecommunications compliance label. This includes customer equipment previously labelled permitted or certified.

Notice for New Zealand

For modem with approval number PTC 211/03/008

- 1 The grant of a Telepermit for any item of terminal equipment indicates only that Telecom has accepted that the item complies with minimum conditions for connection to its network. It indicates no endorsement of the product by Telecom, nor does it provide any sort of warranty. Above all, it provides no assurance that any item will work correctly in all respects with another item of Telepermitted equipment of a different make or model, nor does it imply that any product is compatible with all of Telecom's network services.
- 2 This equipment is not capable, under all operating conditions, of correct operation at the higher speeds for which it is designed. Telecom will accept no responsibility should difficulties arise in such circumstances.
- 3 Some parameters required for compliance with Telecom's Telepermit requirements are dependent on the equipment (PC) associated with this device. The associated equipment shall be set to operate within the following limits for compliance with Telecom's Specifications:
 - a There shall be no more than 10 call attempts to the same number within any 30 minute period for any single manual call initiation, and
 - b The equipment shall go on-hook for a period of not less than 30 seconds between the end of one attempt and the beginning of the next call attempt.
- 4 Some parameters required for compliance with Telecom's Telepermit requirements are dependent on the equipment (PC) associated with this device. In order to operate within the limits for compliance with Telecom's specifications, the associated equipment shall be set to ensure that automatic calls to different numbers are spaced such that there is not less than 5 seconds between the end of one call attempt and the beginning of another.
- 5 This equipment shall not be set up to make automatic calls to Telecom's 111 Emergency Service.

For modem with approval number PTC 211/01/030

- 1 The grant of a Telepermit for any item of terminal equipment indicates only that Telecom has accepted that the item complies with minimum conditions for connection to its network. It indicates no endorsement of the product by Telecom, nor does it provide any sort of warranty. Above all, it provides no assurance that any item will work correctly in all respects with another item of Telepermitted equipment of a different make or model, nor does it imply that any product is compatible with all of Telecom's network services.
- 2 This equipment is not capable, under all operating conditions, of correct operation at the higher speeds for which it is designed. Telecom will accept no responsibility should difficulties arise in such circumstances.

- 3 This device is equipped with pulse dialing while the Telecom standard is DTMF tone dialing. There is no guarantee that Telecom lines will always continue to support pulse dialing.
- 4 Use of pulse dialing, when this equipment is connected to the same line as other equipment, may give rise to bell tinkle or noise and may also cause a false answer condition. Should such problems occur, the user should NOT contact the telecom Fault Service.
- 5 This equipment may not provide for the effective hand-over of a call to another device connected to the same line.
- 6 Under power failure conditions this appliance may not operate. Please ensure that a separate telephone, not dependent on local power, is available for emergency use.
- 7 Some parameters required for compliance with Telecom's Telepermit requirements are dependent on the equipment (PC) associated with this device. The associated equipment shall be set to operate within the following limits for compliance with Telecom's specifications, the associated equipment shall be set to ensure that calls are answered between 3 and 30 seconds of receipt of ringing.
- 8 This equipment shall not be set up to make automatic calls to Telecom's 111 Emergency Service.

Important safety instructions

Read these instructions carefully. Save them for future reference.

- 1 Follow all warnings and instructions marked on the product.
- 2 Unplug this product from the wall outlet before cleaning. Do not use liquid cleaners or aerosol cleaners. Use a water-moistened cloth for cleaning.
- 3 Do not use this product near water.
- 4 Do not place this product on an unstable cart, stand or table. If the product falls, it could be seriously damaged.
- 5 Slots and openings are provided for ventilation; to ensure reliable operation of the product and to protect it from overheating. These openings must not be blocked or covered. The openings should never be blocked by placing the product on a bed, sofa, rug or other similar surface. This product should never be placed near or over a radiator or heat register, or in a built-in installation unless proper ventilation is provided.
- 6 This product should be operated from the type of power indicated on the marking label. If you are not sure of the type of power available, consult your dealer or local power company.
- 7 Do not allow anything to rest on the power cord. Do not locate this product where people will walk on the cord.

- 8 If an extension cord is used with this product, make sure that the total ampere rating of the equipment plugged into the extension cord does not exceed the extension cord ampere rating. Also, make sure that the total rating of all products plugged into the wall outlet does not exceed the fuse rating.
- 9 Never push objects of any kind into this product through cabinet slots as they may touch dangerous voltage points or short-out parts that could result in a fire or electric shock. Never spill liquid of any kind onto or into the product.
- 10 Do not attempt to service this product yourself, as opening or removing covers may expose you to dangerous voltage points or other risks. Refer all servicing to qualified service personnel.
- 11 Unplug this product from the wall outlet and refer servicing to qualified service personnel under the following conditions:
 - a When the power cord or plug is damaged or frayed.
 - b If liquid has been spilled into the product.
 - c If the product has been exposed to rain or water.
 - d If the product does not operate normally when the operating instructions are followed. Adjust only those controls that are covered by the operating instructions, since improper adjustment of other controls may result in damage and will often require extensive work by a qualified technician to restore the product to normal condition.
 - e If the product has been dropped or the case has been damaged.
 - f If the product exhibits a distinct change in performance, indicating a need for service.
- 12 The notebook PC series uses lithium batteries.
Replace the battery with the same type as the product's battery we recommend in the product specification list. Use of another battery may present a risk of fire or explosion.
- 13 **Warning!** Batteries may explode if not handled properly. Do not disassemble or dispose of them in fire. Keep them away from children and dispose of used batteries promptly.
- 14 To avoid hazard of unexpected electrical shock, use the AC adapter only when the wall socket is properly grounded.
- 15 Use only the proper type of power supply cord set (provided in your accessories box) for this unit. It should be a detachable type: UL listed/CSA certified, type SPT-2, rated 7 A 125 V minimum, VDE approved or its equivalent. Maximum length is 4.6 meters (15 feet).
- 16 Always disconnect all telephone lines from the wall outlet before serving or disassembling this equipment.
- 17 Avoid using a telephone (other than a cordless type) during an electrical storm. There may be a remote risk of electric shock from lightning.

Laser compliance statement

The CD or DVD drive used with this computer is a laser product.
The CD or DVD drive's classification label (shown below) is located on the drive.

CLASS 1 LASER PRODUCT

CAUTION: INVISIBLE LASER RADIATION WHEN OPEN. AVOID EXPOSURE TO BEAM.

APPAREIL A LASER DE CLASSE 1 PRODUIT

LASERATTENTION: RADIATION DU FAISCEAU LASER INVISIBLE EN CAS D'OUVERTURE. EVITER TOUTE EXPOSITION AUX RAYONS.

LUOKAN 1 LASERLAITE LASER KLASSE 1

VORSICHT: UNSICHTBARE LASERSTRAHLUNG, WENN ABDECKUNG GEÖFFNET NICHT DEM STRAHL AUSSETZEN

PRODUCTO LÁSER DE LA CLASE I

ADVERTENCIA: RADIACIÓN LÁSER INVISIBLE AL SER ABIERTO. EVITE EXPONERSE A LOS RAYOS.

ADVARSEL: LASERSTRÅLING VEDÅBNING SE IKKE IND I STRÅLEN.

VARO! LAVATTAESSA OLET ALTTINA LASERSÄTEILYLLE.

WARNING: LASERSTRÅLNING NÅR DENNA DEL ÅR ÖPPNAD ÅLÅ TUIJOTA SÄTEESEENSTIRRA EJ IN I STRÅLEN

WARNING: LASERSTRÅLNING NAR DENNA DEL ÅR ÖPPNADSTIRRA EJ IN I STRÅLEN

ADVARSEL: LASERSTRÅLING NAR DEKSEL ÅPNESSTIRR IKKE INN I STRÅLEN

LCD pixel statement

The LCD unit is produced with high-precision manufacturing techniques. Nevertheless, some pixels may occasionally misfire or appear as black or red dots. This has no effect on the recorded image and does not constitute a malfunction.

Macrovision copyright protection notice

This product incorporates copyright protection technology that is protected by U.S. patents and other intellectual property rights. Use of this copyright protection technology must be authorized by Macrovision, and is intended for home and other limited viewing uses only unless otherwise authorized by Macrovision. Reverse engineering or disassembly is prohibited.

Radio device regulatory notice



Note: Below regulatory information is for models with wireless LAN and/or Bluetooth only.

General

This product complies with the radio frequency and safety standards of any country or region in which it has been approved for wireless use. Depending on configurations, this product may or may not contain wireless radio devices (such as wireless LAN and/or Bluetooth modules). Below information is for products with such devices.

European Union (EU)

This device complies with the essential requirements of the European Council Directives listed below:

73/23/EEC Low Voltage Directive

- **EN 60950**

89/336/EEC Electromagnetic Compatibility (EMC) Directive

- **EN 55022**
- **EN 55024**
- **EN 61000-3-2/-3**

99/5/EC Radio & Telecommunications Terminal Equipment (R&TTE) Directive

- **Art.3.1a) EN 60950**
- **Art.3.1b) EN 301 489 -1/-17**
- **Art.3.2) EN 300 328-2**
- **Art.3.2) EN 301 893 *applies to 5 GHz only**

CE  (for 5 GHz device)

List of applicable countries

EU member states as of May 2004 are: Belgium, Denmark, Germany, Greece, Spain, France, Ireland, Italy, Luxembourg, the Netherlands, Austria, Portugal, Finland, Sweden, United Kingdom Estonia, Latvia, Lithuania, Poland, Hungary, Czech Republic, Slovak Republic, Slovenia, Cyprus and Malta. Usage allowed in the countries of European Union, as well as Norway, Switzerland, Iceland and Liechtenstein. This device must be used in strict accordance with the regulations and constraints in the country of use. For further information, please contact local office in the country of use.

The FCC RF safety requirement

The radiated output power of the wireless LAN Mini PCI Card and Bluetooth card is far below the FCC radio frequency exposure limits. Nevertheless, the notebook PC series shall be used in such a manner that the potential for human contact during normal operation is minimized as follows:

- 1 Users are requested to follow the RF safety instructions on wireless option devices that are included in the user's manual of each RF option device.



Caution: To comply with FCC RF exposure compliance requirements, a separation distance of at least 20 cm (8 inches) must be maintained between the antenna for the integrated wireless LAN Mini PCI Card built in to the screen section and all persons.

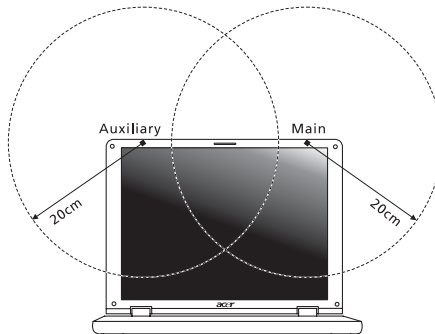

Note: The Acer wireless Mini PCI adapter implements a transmission diversity function. The function does not emit radio frequencies simultaneously from both antennas. One of the antennas is selected automatically or manually (by users) to ensure good quality radiocommunication.

- 2 This device is restricted to indoor use due to its operation in the 5.15 to 5.25 GHz frequency range. FCC requires this product to be used indoors for the frequency range 5.15 to 5.25 GHz to reduce the potential for harmful interference to co-channel Mobile Satellite systems.
- 3 High power radar are allocated as primary users of the 5.25 to 5.35 GHz and 5.65 to 5.85 GHz bands. These radar stations can cause interference with and/or damage this device.
- 4 An improper installation or unauthorized use may cause harmful interference to radio communications. Also any tampering of the internal antenna will void the FCC certification and your warranty.

Canada — Low-power license-exempt radio communication devices (RSS-210)

- a Common information
Operation is subject to the following two conditions:
 1. This device may not cause interference, and
 2. This device must accept any interference, including interference that may cause undesired operation of the device.
 - b Operation in 2.4 GHz band
To prevent radio interference to the licensed service, this device is intended to be operated indoors and installation outdoors is subject to licensing.
 - c Operation in 5 GHz band
- The device for the band 5150-5250 MHz is only for indoor usage to reduce potential for harmful interference to co-channel Mobile Satellite systems.
 - High power radars are allocated as primary users (meaning they have priority) of 5250-5350 MHz and 5650-5850 MHz and these radars could cause interference and/or damage to LELAN (Licence-Exempt Local Area Network) devices.

Exposure of humans to RF fields (RSS-102)

The notebook PC series employs low gain integral antennas that do not emit RF field in excess of Health Canada limits for the general population; consult Safety Code 6, obtainable from Health Canada's website at www.hc-sc.gc.ca/rpb.

Federal Communications Commission Declaration of Conformity

This device complies with Part 15 of the FCC Rules. Operation is subject to the following two conditions: (1) This device may not cause harmful interference, and (2) This device must accept any interference received, including interference that may cause undesired operation.

The following local manufacturer/importer is responsible for this declaration:

Product name:	Notebook PC
Model number:	ZE1
Machine type:	TravelMate C2xx
SKU number:	TravelMate C2xx ("x" = 0 - 9, a - z, or A - Z)
Name of responsible party:	Acer America Corporation
Address of responsible party:	2641 Orchard Parkway San Jose, CA 95134 USA
Contact person:	Mr. Young Kim
Tel:	408-922-2909
Fax:	408-922-2606

Declaration of Conformity for CE Marking

Name of manufacturer: Beijing Acer Information Co., Ltd.
 Address of manufacturer: Huade Building, No.18, ChuangYe Rd.
 ShangDi Zone, HaiDian District Beijing PRCE marking
 Contact person: Mr. Easy Lai
 Tel: 886-2-8691-3089
 Fax: 886-2-8691-3000
 E-mail: easy_lai@acer.com.tw
 Declares that product: Notebook PC
 Trade name: Acer
 Model number: ZE1
 Machine type: TravelMate C2xx
 SKU number: TravelMate C2xx
 ("x" = 0 - 9, a - z, or A - Z)

Is in compliance with the essential requirements and other relevant provisions of the following EC directives.

Reference no.	Title
89/336/EEC	Electromagnetic Compatibility (EMC directive)
73/23/EEC	Low Voltage Directive (LVD)
1999/5/EC	Radio & Telecommunications Terminal Equipment Directive (R&TTE)

The product specified above was tested conforming to the applicable Rules under the most accurate measurement standards possible, and all the necessary steps have been taken and are in force to assure that production units of the same product will continue to comply with these requirements.

 Easy Lai, Director
 Qualification Center
 Product Assurance

09/06/2005

Date

Index

A

- AC adapter
 - caring for v
- audio 28
 - adjusting the volume 28
 - troubleshooting 34

B

- battery pack
 - caring for vi
- BIOS utility 51
- brightness
 - hotkeys 25

C

- caps lock 23
 - on indicator 19
- care
 - AC adapter v
 - battery pack vi
 - computer v
- CD-ROM
 - ejecting 27
 - ejecting manually 34
 - troubleshooting 34
- cleaning
 - computer vi
- computer
 - caring for v
 - cleaning vi
 - disconnecting 40
 - features 9, 29
 - indicators 19
 - keyboards 23
 - on indicator 11, 19
 - security 43
 - setting up a home office 42
 - taking home 41
 - traveling internationally 43
 - traveling on local trips 42
 - troubleshooting 57
 - turning off v
- connections
 - network 47

D

- display
 - hotkeys 25
 - troubleshooting 33
- DVD 52
- DVD movies
 - playing 52

E

- error messages 57
- Euro 26

F

- FAQ. See frequently-asked questions
- frequently-asked questions 33
- front view 11

H

- Hibernation mode
 - hotkey 25
- hotkeys 24

I

- IEEE 1394 port 48
- indicator lights 19
- infrared 47

K

- keyboard 23
 - embedded numeric keypad 23
 - hotkeys 24
 - lock keys 23
 - troubleshooting 34
 - Windows keys 24

L

- LEDs 19
- left view 11

M

- media access
 - on indicator 19
- memory
 - installing 50– 51
- messages
 - error 57
- modem 46

N

- network 47

Notebook Manager

hotkey 25

num lock 23

on indicator 19

numeric keypad

embedded 23

P

password 44

types 44

PC Card 49

ejecting 50

inserting 50

ports 46

printer

troubleshooting 34

problems 33

CD-ROM 34

display 33

keyboard 34

printer 34

startup 33

troubleshooting 57

Q

questions

setting location for modem use
35

S

safety

CD or DVD 65

FCC notice 59

general instructions 63

modem notices 60

scroll lock 23

security

keylock 27, 44

passwords 44

speakers

hotkey 25

troubleshooting 34

status indicators 19

support

information 36

T

touchpad 21

hotkey 25

using 21– 22

travel

international flights 43

local trips 42

troubleshooting 57

tips 57

U

universal serial bus 48

V

view

front 12

left 12

rear 14

right 13

volume

adjusting 28

W

Windows keys 24