

# **Acer MP500**

**User's Manual**

**Ver 1.0**

**acer**

## **Copyright**

Copyright 2006 by Acer Inc., All rights reserved. No part of this production may be reproduced, transmitted, transcribed, stored in a retrieval system, or translated into any languages or computer language, in any form or by any means, electronic, mechanical, magnetic, optical, chemical, manual or otherwise, without the prior written permission of Acer Computer GmbH.

## **Disclaimer**

Acer Inc. make no representations or warranties, either expressed or implied, with respect to the contents hereof and specifically disclaims any warranties, merchantability or fitness for any particular purpose. Any software described in this manual is sold or licensed "as is". Should the programs prove defective following this purchase, the buyer (and not this company, its distributor, or its dealer) assumes the entire cost of all necessary servicing, repair, and any incidental or consequential damages resulting from any defect in the software. Further, Acer Computer GmbH, reserves the right to revise this publication and to make changes from time to time in the contents hereof without obligation to notify any person of such revision or change.

All brand and product names mentioned in this manual are trademarks and/or registered trademarks of their respective holders.

All brand and product names mentioned in this manual are trademarks and/or registered trademarks of their respective holders.

# Contents

I	<b><u>Safety Declaration</u></b>	2
II	<b><u>Product Description</u></b>	2
	1. Main Characteristics	2
	2. Product Distribution Diagram	3
	3. Packed Accessories	3
	4. Battery Charge	4
	5. Connection of External Interface	5
	6. Use of Remote Controller	5
	7. USB Drive Installation	6
	8. Disk Directory Management	8
	9. Safe Movement and Removal	8
III	<b><u>Basic Functions</u></b>	9
	1. Main Menu	9
	2. Video Play	10
	3. Music Enjoyment	11
	4. View Picture	13
	5. E-book	15
	6. Viewing and Recording of External Programs	17
	7. File Operation	18
	8. Menu Setup	21
	9. Firmware Upgrade	25
IV	<b><u>Frequently Asked Questions and Solutions</u></b>	26
V	<b><u>Product Specifications</u></b>	27

## **I Safety Declaration**

1. Please carefully and thoroughly read this safety guide.
2. Please keep this manual secure for future reference.
3. Please keep the unit dry.
4. Please avoid exposing this unit to sunlight.
5. Don't pour any liquid into this unit, otherwise it will cause damage or electric shock.
6. Please contact with a professional for handling this MP500 Player if the following situations occur:
  - ◆ Liquid penetrates into this unit
  - ◆ The unit is affected by damp
  - ◆ The operation of this unit is not normal, or the user can't return to normal operational status by consulting this manual
  - ◆ The unit is dropped or is damaged
7. Please don't use MP500 Player in the following situations:
  - ◆ While driving a vehicle
  - ◆ Carrying out dangerous work
  - ◆ Walking on the street
  - ◆ Any situation that needs full concentration
8. If you want to format the disk of MP500 Player, please select FAT32 to format it. Please don't carry out partition of the disk of MP500 Player.
9. Please don't use liquid or spraying agent to clean this unit. Please use soft, wet cloth to wipe this unit.
10. During listening with earphones, please adjust to suitable volume to avoid hearing from being damaged.
11. Note: Improper use of battery may cause explosion! Please correctly use the battery as per instruction stated in Section: Battery!
12. Don't throw used battery into the waste bin, it should be recycled.

## **II Product Description**

Thank you for purchasing this Acer MP500 product. This kind of product is a high-performance portable multimedia recorder and player with removable Li-Polymer battery. With the use of Acer MP500 product, you can play video or music files with different formats, which will bring you outstanding visual and music experience. And you can record music and video signals. This kind of product is also portable USB storage equipment and you can store and manage your personal data.

### **1. Main Features**

- Display – Supports 3.5" TFT LCD large screen display. Clearly displays picture and video files.
- Mass Storage Volume – 1.8" 20GB in-board hard disk, which can store large amounts of data (30GB/40GB hard disk is optional)
- Video Play – Supports the playing of video files with the formats of MPEG-4 SP, Xvid, and WMV-9 SP@ML.  
*Due to constant changes and the variety of encoding and compression methods for different video file format, some of the video files downloaded from Internet may not be properly displayed on MP500. Even if the file follows "MPAG4" format, the file may still not be able to display by MP500 properly due to special format characteristics.*
- Music Play – Support the playing of music files with the formats of MP3 (MPEG1 Layer2, Layer3), and WMA (WMA 9).
- Lyric Synchronization – Supports the synchronous display of sound and lyrics and

educational texts.

- Image Viewing – Supports the JPEG/BMP/GIF file format. You can copy images into the MP500 for viewing.
- Text File Reading – Supports .txt text reading function (e-book function).
- Recording – Supports the recording function of video and music. You can use the unit to record video and music signals from external sources.
- AV Input and Output – Supports AV input interface. You can enjoy television programs through the large screen of MP500, and you can carry out remote control via infrared. Also supports AV output interface, and you can transfer video and music signals the MP500 is playing to peripheral music and video output devices (such as television).
- USB 2.0 Interface – Supports USB 2.0 Full-Speed and Low-speed operation.
- SD/MMC Card Slot – Supports Extended SD/MMC Card.
- Battery – In-board chargeable Li-Polymer battery, which can repeatedly charge the battery.
- Video Format Conversion – You can convert unplayable video files into playable format through video format conversion software.
- Multi-Languages – Supports many languages, including nine language modes such as simplified Chinese, traditional Chinese, English, German, French, Italian , Spanish and Dutch.
- Firmware upgrade – Support firmware upgrade.

## 2. Button Location

## 3. Packaging / Accessories

Please confirm the packaging and accessories have the contents below:

- ✓ Acer MP500 Player
- ✓ Chargeable Li-Polymer battery
- ✓ User's Manual
- ✓ Power Adapter
- ✓ Installation CD
- ✓ AV Cable
- ✓ USB cord
- ✓ Stereo earphones
- ✓ Remote Controller
- ✓ Portable leather cover

## 4. Charging of Battery

This section includes: installation of battery, charging of battery, and the use of external power adapter.

### 4.1 Installation of Battery

- 1) Confirm the power of MP500 player has been turned off, and open the cover of battery chamber as per the indicated direction.
- 2) Load the chargeable battery and close the cover of battery chamber.

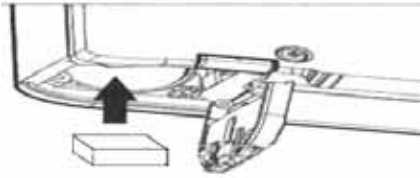

#### 4.2 Power Volume Indication



Battery is fully charged



Battery is partially drained



Battery is drained

**Note:** If the power volume indication of battery shows only one block or is empty, it indicates the power supply is obviously lacking, please charge the battery.

#### 4.3 Charging of Battery

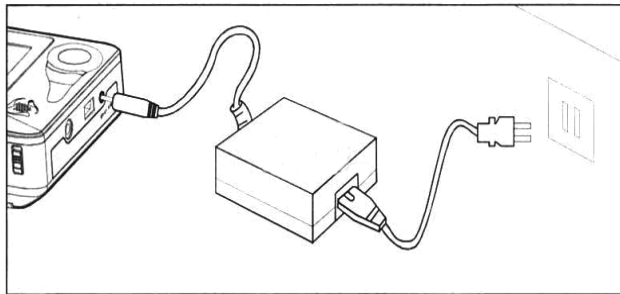

You can use the external power adapter to charge the battery. The charging can be performed when the power of MP500 Player is on or off. The detailed charging method is as follows:

- 1) Load the chargeable battery supplied with this unit.
- 2) Connect the power cable with the power adapter.
- 3) Insert the DC plugs of power adapter into the DC input port of MP500 Player.
- 4) Insert the power plug into the power socket.

**Note:** Please don't remove the battery during the charging process.

#### 4.4 Use of External Power Adapter

You can use external power adapter to supply directly power for MP500 Player. The operation method is the same with the battery charging method.

#### 5. Connection of External Interface



- 1) Connect Television for viewing  
Use AV cable to connect to AV out socket of MP500 Player and input socket of signal of television.
- 2) Connect Television for Recording  
Connect the output socket of signal of television set and AV input socket of MP500 Player through AV cable.
- 3) Connection of Music Device  
Insert the AV cable into the AV input socket of MP500 Player. Connect the music signal (left/right) of AV cable through "Y" type cable. Insert other end of Y type cable into the output socket of music device.
- 4) Connection of Computer  
Use USB cord to connect the MP500 Player with computer, for data transfer.
- 5) Connection of Stereo Earphones  
Insert the stereo earphones into the corresponding socket of MP500 Player.

## 6. Use of Remote Control(Optional)

This section describes how to use the remote controller to operate the MP500 Player. The key functions on the remote control correspond to the key functions of MP500 Player.

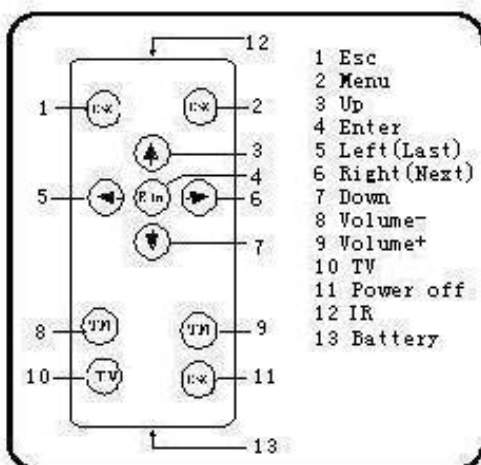

S/N	Remote Controller	Function
1	ESC	Escape (or back to the previous level)
2	MENU	Enter into the interface of menu
3	UP	Direction selection (up)
4	ENTER	Confirm
5	LEFT/LAST	Direction selection (left)/previous file
6	RIGHT/NEXT	Direction selection (right)/next file
7	DOWN	Direction selection (down)
8	VOLUME -	Decrease the volume
9	VOLUME +	Increase the volume
10	TV	Toggle the screen
11	POWER OFF	Power switch
12	IR	Infrared sensing port
13	Battery	Battery

## 7. Installation of USB Driver

USB driver only needs to be installed for Windows98/se operation system. The installation steps are as follow:

- 1) Insert the CD provided with this unit into the CD-ROM. Double click the Setup.exe file under the root directory of CD, and start the installation of driver.

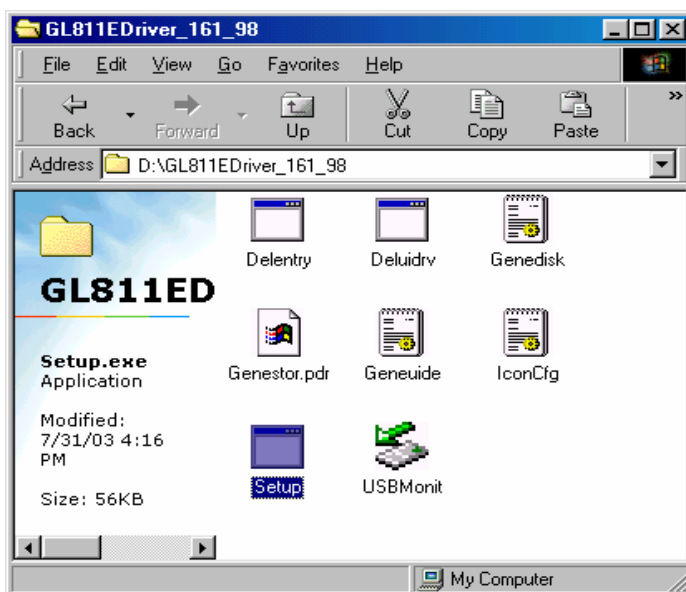

- 2) Click <OK>, and restart computer. The installation of driver is finished;



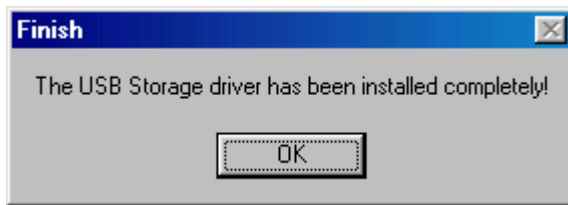

### Confirm the USB driver has been installed.

- 1) Turn on the power of MP500 and use USB cord to connect with computer.
- 2) Select [Control Panel / System / Device Manager]. The following interface is to be displayed;

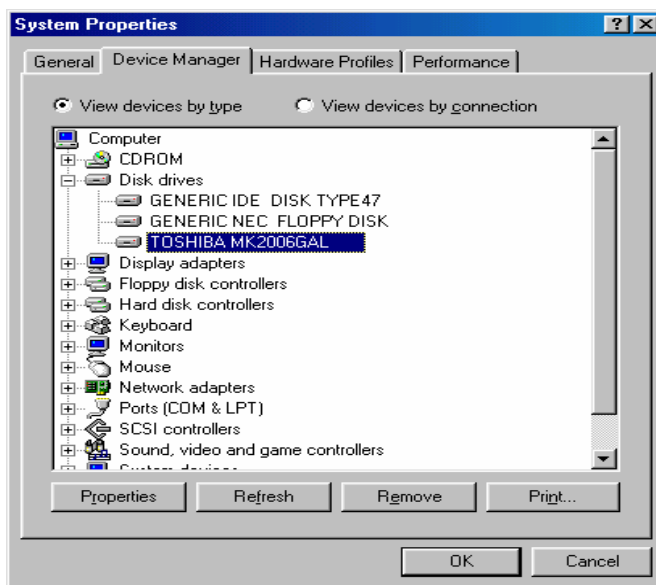

- 3) Select the hard disk drive and the installed USB driver will be displayed;

**Note:** If the USB driver hasn't been displayed as per the above, please uninstall the USB drive and reinstall it.

## 8. Disk Directory Management

- 1) When the host machine is normally connected with the computer, the disk icon will be displayed in [windows explorer]. There are six directories, [music], [video], [photo], [textbook], [VideoRecorder] and [MusicRecorder];

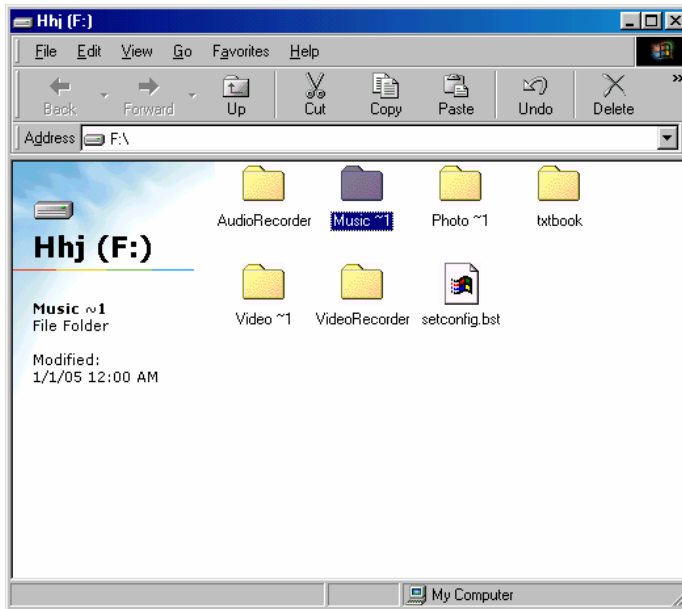

**Note:** Please don't delete manually such default directories as [video], [music], [photo], [textbook], [VideoRecorder] and [MusicRecorder] under the root directory of disk because the deletion of such directories will result in the abnormal operation of this product. If these directories above have been deleted unintentionally, please re-open these directories after this unit is shut off, and the MP500 Player will automatically establish such directories for you.

2) Please store these files into the corresponding directories as per their types.

- ◆ Music directory: Music file
- ◆ Video directory: Video file
- ◆ Photo directory: Picture file
- ◆ Textbook directory: Electronic book
- ◆ VideoRecorder directory: Video record
- ◆ MusicRecorder directory: Music record

## 9. Safe Deletion from Computer

1) Select the icon of [plug and play device] in the task column, click right key and select [safely delete hardware];



- 2) Select the hardware device needing to be stopped, and click [Stop] button;
- 3) Select the drive needing to be stopped, and click [Confirmation] button;
- 4) Click [Close] button to finish the entire operation;

**Note:** Abnormal interruption of the connection of this product with the computer may cause

damage to this product.

## 10. Power on / Power off

- 1) Power on: Hold down the on/off key for 2 seconds, and the screen will display the power on logo of Acer. It will enter into the interface of main menu.



- 2) Power off: Hold down on/off key for 2 seconds, and unit will turn off .

## III Basic Functions

### 1. Selection of Main Menu

After the unit is turned on, the main interface will be displayed on the screen (as shown in the below figure).

Several icons are displayed on the main interface: video, music, photo, e-book, record, files ,resume and setup. Press “Esc” key to hide the icon of main interface, and the background will appear clearly on the screen. If the icon of Menu key is pressed, it will be re-displayed on the main interface. Press four-direction key to select your desired functions (up, down, left and right), and press Enter key to confirm, and enter into the corresponding operational interface. Press Lock key for 2-3 seconds to turn on the function of locking keyboard, and re-press Lock key to turn off the function of locking keyboard.



### 2. Video Play

- 1) Select video function on the main interface and press Enter key to confirm, and enter into the interface of video file list.



- 2) Press “menu” key to call up the file operation menu. The detailed operation method is shown in the description in the file operation section.



- a. Desktop: Select “Desktop” to go back to the main interface.
  - b. View, new, copy, move, paste, delete, rename
  - c. File information: Open or close the file information column.
- 3) In the video file list interface, use ‘up’ or ‘down’ keys to select your desired video file and press “Enter” key to start play.
  - 4) During the playback of video, you can perform the following operations:
    - a. Press ‘Esc’ key to stop playback and back to the video file list.
    - b. Press “up” or “down” keys to adjust the volume of video play.
    - c. Press “Enter” key to pause playback, and press “Enter” to resume playback.
    - d. Press “left” or “right” keys to play previous file or next file.
    - e. Press “left” or “right” keys and hold for over 2 seconds to fast forward or rewind and enable a search with the playtime/progress bar, release the key to resume playback.

**Note:** The fast forward or rewind only works with video paused.

- f. During the playback of video, press “menu” key to display the icons of function menu.



(Pause, ff, rewind, next, previous, repeat mode, and ratio of width and height)

 (Repeat mode: single repeat, non-stop repeat)

 (Ratio of width and height: 4:3, 16:9, original dimension display, ratio of width and height)

**Note:** Use “right” or “left” keys to select the menus above and use “Enter” key to confirm.

- g. During selection of the functions of fast forward or rewind in the above menu, you can use “right” or “left” keys to change the rate of fast forward or rewind (X2, X4, X8, X16), and press “Enter” key to resume normal playback.

**Note:** The fast forward or rewind is performed while the video is playing. This function will help you to select precisely your desired playing position.

- h. This machine has an auto-recording function. If you quit while playing a video, the player will record the current position. When you want to start playing the video from where you stopped last time, you can select Resume in the main menu.

### 3. Music Enjoyment



- 1) Select “Music” function in the main interface and press “Enter” key to confirm, and to enter into the interface of music file list.

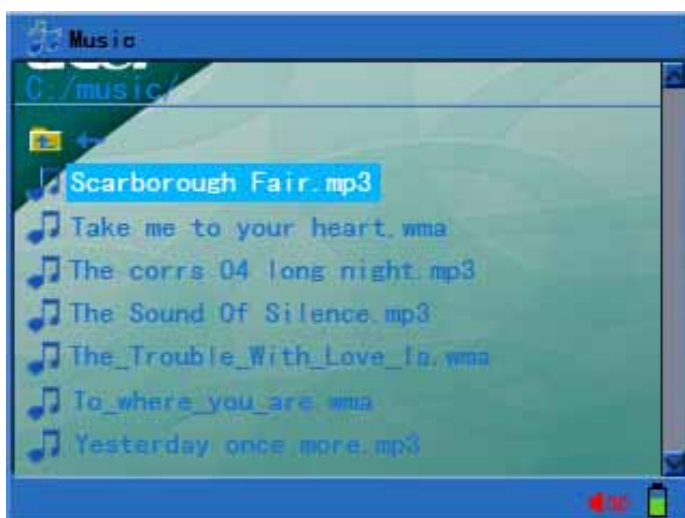

- 2) Press “menu” key to call up the menu of file operation, and the detailed operation method is stated in the description of file operation section.



- a. Desktop: Select “Desktop” and return to the main interface.
  - b. View, new, copy, move, paste, delete and rename: Refer to file operation description.
  - c. File information: Open or close the file information column.
- 3) In the interface of music file list, use “up” or “down” keys to select music file, and press “Enter” key to confirm. Unit will enter into the music play interface, and start to play music.

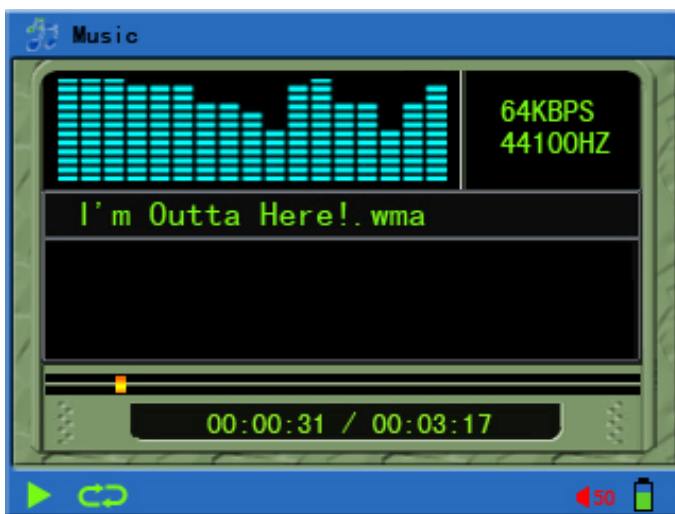

- 4) During music playback, you can perform the following operations:
  - a. Press “Esc” key to stop playback and return to file directory list.
  - b. Press “up” or “down” keys to adjust the volume of video playback.
  - c. Press “Enter” key once to pause the playback, and press “Enter” again to resume playback.
  - d. Press “left” or “right” keys and hold for over 2 seconds to fast forward or rewind and enable a search with the playtime/progress bar. Release the key to resume playback.
- 5) During the video playback period, press “menu” key to pop up the icon of music function menu:



(Pause, fast forward, rewind, previous, next, repeat mode A-B repeat reading, ID3 information, EQ function, and background music)



(Repeat mode: Single repeat, non-stop repeat, and random play)



(Music information, and display of LRC lyric)

**Note:** Use “left” or “right” keys to select the above menu, and use “Enter” key to confirm. Press “Esc” or “Menu” keys to resume normal playback.

- 6) During music playback period, the LRC file of lyric shall be Unicode encoding format, and the file name of lyric shall be in conformity with the file name of song. Use notebook of computer to open the downloaded lyric file and save as Unicode encoding.
- 7) Select background music playback from the above menu, and the music will continue to play on return to the upper level window.
- 8) This machine has an auto-recording function. If you quit while playing music, the player will record the current position. When you want to start playing the music from where you stopped last time, you can select Resume in the main menu.

#### 4. View Photos



- 1) Select “photo” function in the main interface and press “Enter” key to confirm, and to enter into the interface of photo file list.

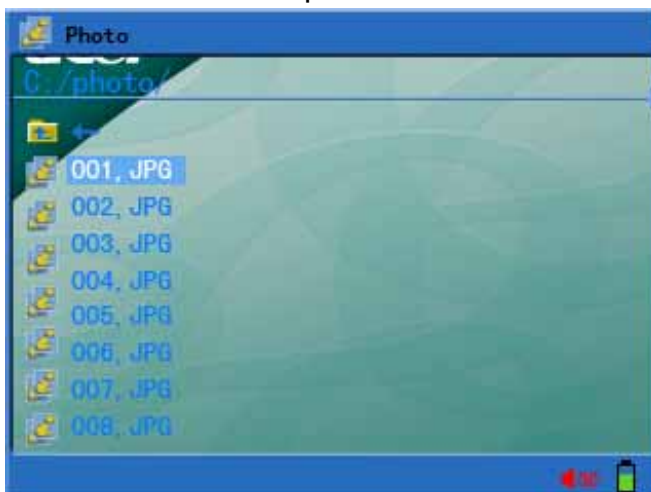

- 2) Press “menu” key to call up the file operation menu and the detailed operation method is shown in description of file operation section.



- a. Desktop: Select “Desktop” and return to the main interface.
  - b. View, new, copy, move, paste, delete and rename: Refer to file operation description.
  - c. File information: Open or close the file information column.
- 3) In the interface of photo file list, use “up” or “down” keys to select picture file, and press “Enter” key to confirm, and start to view photos.
- 4) During photo viewing, you can perform the following operations:
- a. Press “Esc” key to stop photo viewing and return to file directory list.
  - b. Press “left” or “right” keys to display the previous photo or next photo.
- 5) During photo viewing, press “menu” key to pop out the picture function menu:



(Next, previous, view mode, setup as background, left rotation 90°, right rotation 90°, zoom out, zoom in, picture display mode, and background music)



(View mode: Slide display, pause of slide display)



(Picture display mode: Four pictures, nine pictures, and one picture)

- a. You can use the above menu to open or close the slide function. You can setup the display interval of slide in the setup menu.
- b. Desktop Background: Select “setup as background” function in the above menu, and the current picture will be set as desktop background. In the MP500, the stored pictures can be set as desktop background by using such function.
- c. Under the condition that the picture is zoomed out, use “up”, “down”, “left” and “right” keys to move the picture and press “Enter” key to exit the zoomed out status.
- d. Select Background Music in the above menu to change background music and continue to view the pictures.

**Note:** If you want to play picture and music synchronously, unit will first play music and select background music in the menu.

## 5. E-book Reading





- 1) Select “E-book” function in the main interface and press “Enter” key to confirm, and to enter into the interface of E-book file list.

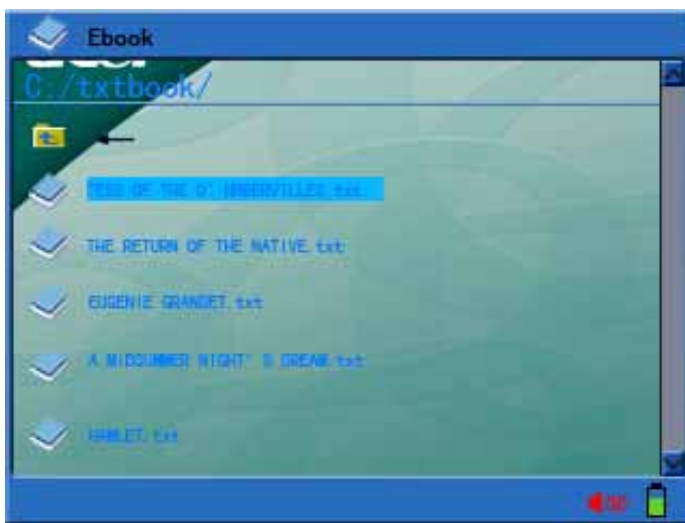

- 2) Press “menu” key to call up the file operation menu and the detailed operation method is shown in the description of file operation section.



- a. Desktop: Select “Desktop” and return to the main interface.
- b. View, new, copy, move, paste, delete and rename: Refer to file operation

description.

c. File information: Open or close the file information column.

- 3) In the E-book file list interface: Use “up” or “down” keys to select E-book, and press “Enter” key to open and display electronic book on the screen.

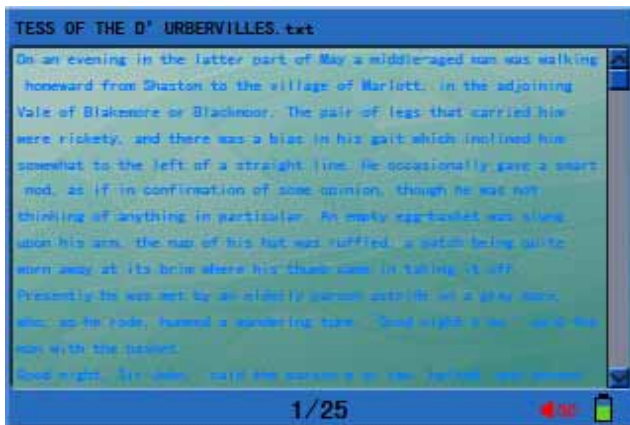

- 4) During the electronic book reading period, you can perform the following operations:
- a. Press “up”, “down” keys to page up and page down the viewing pages.
  - b. Press “Esc” key to quit electronic book reading and return to file list.  
If the viewing pages of electronic book are over 10 pages, press “Esc” key to return to the display of the dialogue box “Save bookmark?”. Selecting “yes” will save, and selecting “no” will not save bookmark.
  - c. Press “left” or “right” keys to display previous or next file.
- 5) During reading of electronic book, press “Menu” key to pop up the function menu.



(Previous file, next file, background music)

Select Background Music in the above menu to change background music (if the viewing pages are greater than 10 pages, the bookmark will be automatically saved).

**Note:** If you want to play the picture and music synchronously, unit will first play music and select background music in the menu.

- 6) The supported file formats in the e-book are as follows: \*.txt & \*.lrc, and the file encoding is Unicode.

## 6. Viewing and Recording of External Programs



Before powering on this unit, please use AV cable to connect the AV input connector of

MP500 Player, and AV output connector of A/V device, respectively.

1) Program Record:

- a. In the main interface, select “Record” and press “Enter” key to confirm that it has entered into the recording interface.



- b. Select the “RecKind”: “Video”, “Music” (only records music) with signal input, and speech (only recorded by microphone), and press “Enter” key to confirm.
- c. Select “Quality”: HighQ, MediumQ, and LowQ, press “Enter” to confirm.
- d. Press “Esc” key to stop the recording, and close MP500 and remove AV cable.
- e. Press “Return” key to stop recording. Power off the MP500 and remove AV cord.
- f. During recording , you can select “Preview” function (press “Enter” key) to stop the recording, but the playback function is still active at that time. Press “Enter” key to continue the recording. Such function will allow you to preview while nothing is being recorded.

2) Video Output Function:

- a. Please use AV cable to connect the AV output connector of MP500 Player and AV input connector of A/V device, respectively, to enjoy the large-screen video and stereo music. (For the connection, please refer to the User’s Manual of AV device).
- b. Turn on the MP500 Player and TV or stereo music device, and set up the MP500 for normal video or music playback. Eventually press “Suspend” key (don’t press it for a long time), the video will convert into TV display, and music will convert into stereo music device output. Pressing “Suspend” key again will stop AV output, and resume the display of MP500 Player.

**Note:** The setup of MP500 TV device shall be in conformity with the setup of TV during video output period. (The MP500 TV Setup is shown in setup menu, and TV Setup of TV is shown in User’s Manual of TV device.)

## 7. File Operation



- 1) In the main interface, select “file” and press “Enter” key to confirm that unit has entered into the selection interface of storage device. You can store the data file or music or video files in the hard disk or extended storage device (such as SD/MMC card).

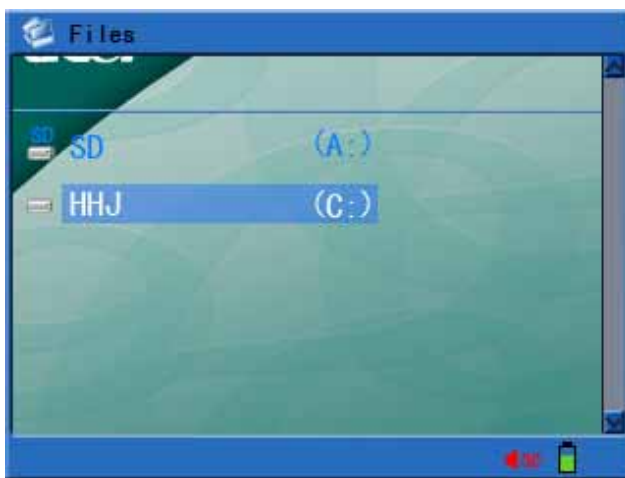

- 2) If your data file or music file or video file is stored in the hard drive, select C drive, and press “Enter” key to enter into the file directory list interface.



- 3) Use “up” or “down” key to select the file or folder you want to access, and then press “menu” key to call up the file operation menu.



- a. Desktop: Select "Desktop" and return to the main interface.
- b. View: Select "view" to enter into the selected directory. (if the folder is selected, such operation will appear in the menu).
- c. Copy: Select the file or folder you want to copy, press "menu" key to call up the operation menu, select "copy", then press "Menu" key under the objective directory to call up the operation menu, select "paste", the window "Paste?" will appear, selecting "YES" will start the pasting, and selecting "NO", it will not paste. (If the file is selected, such operation will appear in the menu.)
- d. New Folder: Press "Menu" to call up the operation menu, and select "new" option. The name character list will appear after selection. Press "Menu" key to store after the folder is named, and the new folder is OK.
- e. Move: Rest the cursor on the file or folder to be moved, press "Menu" key to call up operation menu, select "move", the hint "Move?" will appear at that time. Select "Yes", and press "Menu" key under the objective directory to call up operation menu. Select paste, the hint "Paste?" will appear, then select "Yes" or "No".
- f. Paste: Used during the operations of copy and move.
- g. Delete: Rest the cursor on the file or folder to be deleted, press "Menu" key to call up operation menu, select "delete", and hint "Delete?" will appear at that time. Select "Yes" or "No".
- h. Rename: Rest the cursor on the file or folder to be renamed, press "Menu" key to call up operation menu, select "rename", and the name character list will appear at that time. Use direction key to select character, and the middle button of square key will confirm the input. Press "Menu" key to store name, and pressing "Esc" key will exit and will not perform rename operation.
- i. File Information: Open or close file information column.

## 8. Setup Menu



- 1) Select "Setup" in the main interface, and press "Enter" key to confirm, and to enter system setup interface.



- 2) System setup menu includes the following content:
  - a. Display: This menu setup item includes backlight brightness, text color, focus text color and focus color.

Backlight Brightness: To setup the backlight brightness: 10% (10% of full brightness), 20% (20% of full brightness)...100% (full brightness).

Text Color: **Color of unhighlighted text. Color values from 001 to 255.**

Focus Text : **Color of highlighted text. Color values from 001 to 255.**

Focus Color: **Color of highlight bar. Color values from 001 to 255.**



- b. Power Setup: This menu setup item includes backlight setup and power off.

Backlight Setup: For automatic shut off of the LCD backlight: 0 ~ 255 seconds are available, and 000 is power off (Disable this function).

Power Off: For automatic shut off: 0 ~ 255 min are available, and 000 is power off (Disable this function)

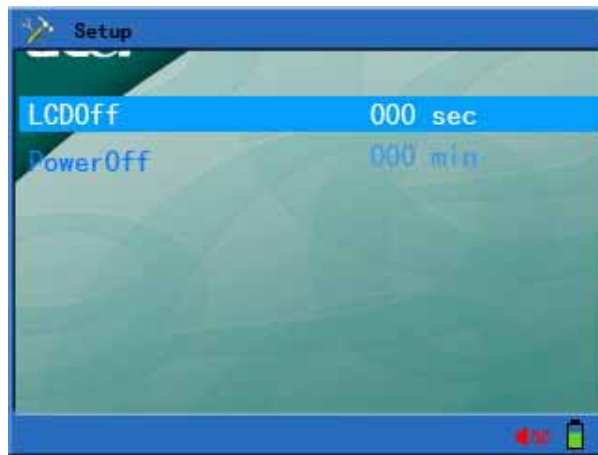

- c. System Setup: This menu setup item includes setups of language, television, system information and factory defaults.

Language: To setup the interface language as eight languages such as simplified Chinese, traditional Chinese, English, German, French, Italian, Spanish and Dutch.

Television: To setup the formats of television: PAL/NTSC.

System Information: To check the company information, production description, revision time, remaining volume, and used volume.

Factory Defaults: To reset to original factory settings.



- d. Playback Mode Setup: This menu setup item includes picture interval time and music playback mode.

Picture Interval Time: To setup automatic view interval of picture, 001 ~ 255 seconds are available.

Music Play Mode: To setup music playback mode, three modes such as random play, play all, and single cycle.

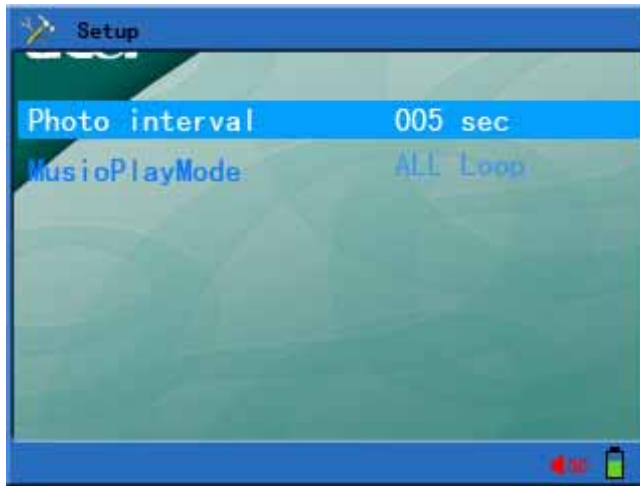

## 9. Firmware Upgrade

You can download the firmware with new revision, and you can upgrade this product through the following steps.

- 1) Visit homepage of Acer Company ([Http://www.acer-euro.com](http://www.acer-euro.com)) and download the latest firmware file of this product.
- 2) Connect this product with the computer through USB cord.
- 3) Copy the latest firmware file to the root directory in the in-board hard disk of MP500 Player.
- 4) Normally disconnect the connection between this product and the USE cord of computer.
- 5) Restart this unit and the upgrade of this product will finish automatically.

Note: Please ensure the power capacity is enough before upgrade. If the power is interrupted during the upgrade process, this product may suffer serious damage. So, connect the power adapter before upgrade to ensure a continuous power supply.

## IV Frequently Asked Questions and Solutions

This section will provide solutions for some common problems during the use of this product. Please read this section to see if it can resolve the existing problems. If they can't be resolved, please contact with customer service.

1. Question: The unit can't be turned on, and the LCD doesn't display any information.  
Answer: Please confirm if the battery needs to be charged.
2. Question: The keys don't work.  
Answer: 1) Check if LCD will display "hold" message;  
2) If the "hold" message is displayed, please press "Lock" key for 2 seconds to turn-off Lock function.
3. Question: When selecting the television as output mode, the television picture shakes or the picture can't be normally displayed.  
Answer: When using television to view, please firstly setup correctly the [tv standard]. (In China and Europe, please use [pal], and in Korea, please use [ntsc].)
4. Question: Sudden power off



Answer: 1) Please check the [power off] setup in the [system set] of main menu interface;

2) Please check if the battery power is low, if so it should be charged.

5. Question: LCD screen suddenly powers off

Answer: Please check if Pause key is pressed and screen conversion has begun.

6. Question: Doesn't play video, music and picture files.

Answer: 1) The file format shall be within the supporting scope of this product;

2) Please confirm if the file format belongs to the format supported by this product, and if the correct play mode is selected.

3) If the file format is not within the supported scope, please use the format conversion software described in this manual to convert the file format into the supporting format.

7. Question: There is no sound, or volume is too low during the playback of video and music.

Answer: Please confirm if the volume is too low. Change the volume through the volume adjusting key.

8. Question: The menu is too small during video playback or picture view.

Answer: 1) The menu of recorded video file is too small.

2) The self-dimension of picture file is too small.

## V Product Specifications

	Category	Parameter Specifications
<b>System</b>	<b>Built-in Storage</b>	1.8" 20GB Hard Disk SD / MMC Card
	<b>File Management</b>	Single file copy & paste, File/ Folder deletion, Rename and Folder Creation
	<b>File System</b>	FAT 16/32
<b>User Interface</b>	<b>Key Definition</b>	Power, Suspend, Up, Down, Left, Right, Esc, Mode, Lock
	<b>Remote Control</b>	Infrared sensor
	<b>Language</b>	Multi-language Menu and Filename Display
	<b>File View Mode</b>	List View & Icon
<b>Power Supply</b>	<b>Switching Adapter</b>	AC 100-240V in, DC 5V, 2.4A output
	<b>Battery</b>	Rechargeable Li-Polymer 3.7V/1800mAh
	<b>Playback Time</b>	Video: 4 hours, Music: 8 hours (average)
	<b>Power Saving</b>	Auto Power off, Screen saver and Hard Disk spin down
<b>Display</b>	<b>Interface</b>	3.5" TFT LCD
	<b>Resolution</b>	320x240 (RGB) Pixels
	<b>Brightness</b>	Backlight Adjustable
	<b>View Angle</b>	Up: 10deg, Down: 30deg Left: 45deg, Right: 45deg
<b>AV Input / Recording</b>	<b>Video</b>	CVBS (PAL/NTSC)
	<b>Music</b>	Line in Stereo
	<b>Speech</b>	Built-in Microphone
<b>AV Output</b>	<b>Video</b>	TV Line out (PAL/NTSC)
	<b>Music</b>	Line out Stereo
	<b>Earphone</b>	30mW, 320hm, 1 outlet
<b>Firmware Upgrade</b>	<b>DSP</b>	System Auto Upgrade when Update File available
<b>USB 2.0</b>	<b>Device</b>	USB 2.0 /USB 1.1 interface
		Operation System: Windows98/98SE/ME/2000XP Mac OS 9.0 and Later
<b>General</b>	<b>Dimensions</b>	126x82x24 mm
	<b>Weight</b>	220g wttth battery
	<b>Operation Temperature</b>	0 to 40

## Supported File Types And Functions

		File Type	Description
<b>Decoding</b>	<b>Video</b>	MPEG-4(*.ASF, *.AVI)	MPEG-4 Simple Profile 720*480 @ 30fps 2-channels MPEG-1 & 2 Layer3(MP3) Video Bit rate Up to 4Mbps
		MPEG-4(*.MP4)	MPEG-4 Simple Profile 720*480 @ 30fps 2-channels MPEG-4 AAC-LC Video Bit rate Up to 4Mbps
		XVID (*.AVI)	Up to 640*352 @ 30fps, MPEG-1&2 Layer III Video Bit rate Up to 3.5Mbps
		WMV9 (*.WMV or *.ASF)	WMV9 SP@ML 352*288 @ 30fps, WMA9 L2 Video Bit rate Up to 4Mbps Minimum Support 10fps
	<b>Music</b>	MP3 (*.MP3)	MPEG-1&2 Layer III, sample rate up to 48KHz , Bit rate:24-320Kbps , CBR&VBR, 2-channels
		WMA (*.WMA)	WMA8/9 ,sample Rate up to 48KHz ,Bit rate :32-384Kbps,CBR , 2-channels
	<b>Image</b>	JPEG (*.JPG)	Baseline YUV and Grayscale (No progressive) Up to 3264*2448 Pixels for HDD
		GIF (*.GIF)	Static; Up to 1000*1000
		BMP (*.BMP)	Monochrome,8-bit Indexed-Color ,RGB ,RLE8 Up to 1400*1050
<b>Encoding</b>	<b>Video</b>	ISO MPEG-4 (*.ASF)	320*240 @ 30 fps, MP3 Stereo
	<b>Music</b>	MP3 (*.MP3)	2 Channels : 16KHz ,32Kbps 24KHz , 64Kbps 32KHz , 96Kbps

***acer***

<http://www.acer-euro.com>